



Ticuna

Wüxigu tangué

4

Popera i buxügü i wüximaepüxarü taunecüāxgüxüarü

La ciudadana y el ciudadano que queremos





Wüxigu tangué

4

Popera i buxügü i ägumucuarü taunecüãxgüxüarü



Dirección General de Educación Básica Alternativa, Intercultural Bilingüe
y de Servicios Educativos en el Ámbito Rural

Dirección de Educación Intercultural Bilingüe

Wüxigu tangué

Cuaderno de trabajo y folder - inicial 4 años Ticuna

©Ministerio de Educación
Av. De la Arqueología cuadra 2, San Borja
Lima, Perú
Teléfono: 615-5800
www.gob.pe/minedu

Cuarta edición, 2020
Tiraje: 313 ejemplares
Impreso en Diciembre 2020

Elaboración de contenido

Linin Pereira Farias

Revisión de contenido

Nelcy Magali Pashia Moreno

Revisión lingüística

Edinson Ysrael Huamancayo Curi

Asesoría y revisión técnica Digeibira-DEIB

Bertha Liliana Pacheco Díaz

Ilustraciones

Edson Hugo Tello Ataucuri
Archivo Digeibira-DEIB

Diseño y diagramación

Nelson Ramón Obando Vásquez,
César Adolfo Yeckle Castro

Cuidado de la edición

James Matos Tuesta



Impreso en:
CECOSAMI S.A.
Cal. 3 Mza. E Lote 11 Urb. Santa Raquel - Lima - Ate
RUC: 20469820531

Hecho el Depósito Legal en la Biblioteca Nacional del Perú
N.º 2020-07613

Todos los derechos reservados. Prohibida la reproducción
de este libro por cualquier medio, total o parcialmente, sin
permiso expreso de los editores.

Impreso en el Perú/*Printed in Peru*

Pexu chanawex

Pabuxŭgŭ pexŭchanawex i ñaa ũmatŭxŭ.

Ñaa popera rŭ cucax nixŭ.

Naxŭ i wŭxi taaxŕmaxŕ, rŭ poramaxŕ, tŭmaarŭ ngŭxŕmaxŕ a nguextŕruŭ.

Nawá cuxŭ narŭ nguxŕxŭcax i ngŕma guxŭma nŭxŭ cucuax rŭ cuxŭname nacax cunxŭ i ñaa poperawá ũmatugŭxŭ.

Nŕa popera rŭ tŭxna nanaxŕ namuxŭraxŭ i puracŭgŭ. Cŭxica rŭ cumŭcŭgŭarŭ rŭ cuxrŭ papaarŭ ngŭxŕmaxŕ.

Ngema wŭxichigŭ i poperatŭwá ngŕxmaxŭ tŭxŭ narŭ ngŭxŕŕ, tŭxŭ nŭxŭ nacuaxŕŕ i tacŭma i mexŭ i nuxcŭmaxŭ, toxrŭ ŭanegŭwa rŭ toxrŭ petagŭ, tacŭmagŭ i ngŕmaxŭchiga tamaxŕ i ŭ wŭxichigŭ nachianegŭwá nagu inamaxŕ. Rŭ nŭxŭ i ngŕchaŭacŭmaxŕ i nŕa naŕnewá nŭxŭ i daux, naŭgŭ, naŕŭgŭ, choxnigŭ rŭ werigŭ.

Ngexgumarŭxŭ ngŕma nagu i maxŕ, cuaxgŭ i toxrŭ nachianegŭarŭ i nangŕmaacŭ nŭxŭ i cuaxŭcax nataxcŭ i ngupetŭxŭ nguxŭma i nachianegŭwá.

Nŭxŭ i cuaxŕcŭmaxŕ, ngemaxŕ marŭ ngupetŭxŭ, rŭ ngexwacaŭŭ i mgupetŭxŭ i cuxrŭ ŭanewá.

Toatŭwá i poperaatŭ nŭxŭ nixŭchiga naŭxŕcŭ naxŭ i nanguxŭraŭ tamŭcŭgŭmaxŕ papogŭmaxŕ, tanemaxŕ, nguepataxŭwá tana ŭgŭ inanguxŭrauxŭ i pura cŭgŭ papagŭarŭ ngŭxŕmaxŕ.

Nŕa poperawa tamaxŕ nŭxŭ nixŭ nanaxca i nguexŭ, inŭcaxweŕcŭ wiyaeŕcŭ, chauxetaŕcŭ, nagurŭ inŭŕcŭ, nŭgŭmaxŕ nangugŭŕcŭ, naŭacŭ, ngŕxguma naŭnŭcaxwaegŭgu i nguepataxŭwá ngupetŭxŭ, ngŕma nachiga nŭxŭ ixaixŭwa, yigu i mexŕchigŭxŭcax i wŭxichigŭ i ngunexŭgu namexŕchigŭxŭca.

Cumaxŕ nŭxŭ chixŭ rŭ nŭxna nadau nŭxŭ cungechaŭŕcŭmaxŕ i naa popera. Rŭ ngŕma nŭxŭ cuangaux i cuaxgŭ rŭ cumŭcŭruŭ tanixŭ i.

Chaugü chaüxchicünaxã rü
chanaxümatü i chauega.









**Nametügarü
buxgü**



Nüxü taĩnũ nachiga i orixgü i naĩnecücax

Nguexëteruũ nagu i ü

Tümaũtawa taxĩ ya nüxü cuaxe nangexta nangox i orixgü.

Toxrü nguepataüwa nachiga tidexagü i nguxüma nüxü i inüxü i orixchiga.

Wena nüxü nixĩ ugü.

Nguexëteruũ rü buxügüna ca taxü.

¿Taxcü nangoxë ga cowü?

¿'Taxcüchi nixi i ngöxgü ega taguchima nangoxgu ga cowü?

¿Texegü tuxé tarüngüxeeü?

Noxe rü buxügü.

¿Ngexta tanaxü?

Noxepatawa exna nguepataüwa.

¿Taxcü tanaxwaxe'?

Naxchicünaxa, i cowüchiga.

Taxcü ningëchigü ga cowü noxrü pexchigu. Naüxchicünaxã i oxi cowüarü naxweta orixchiregümaxã.



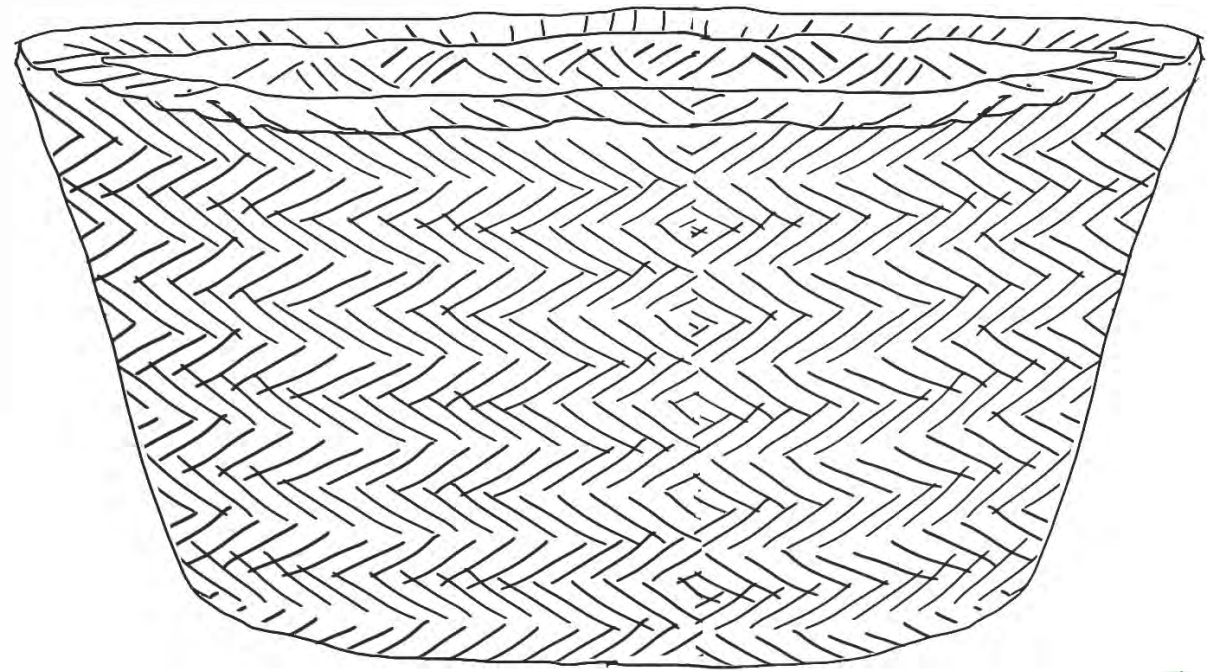
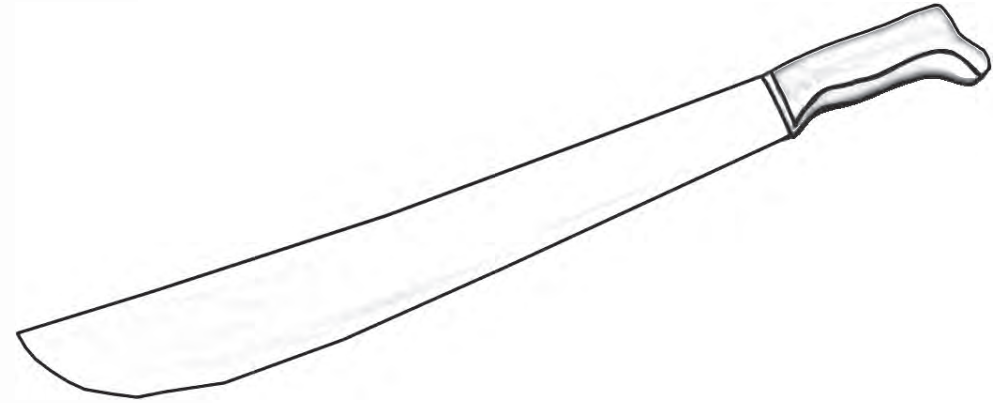
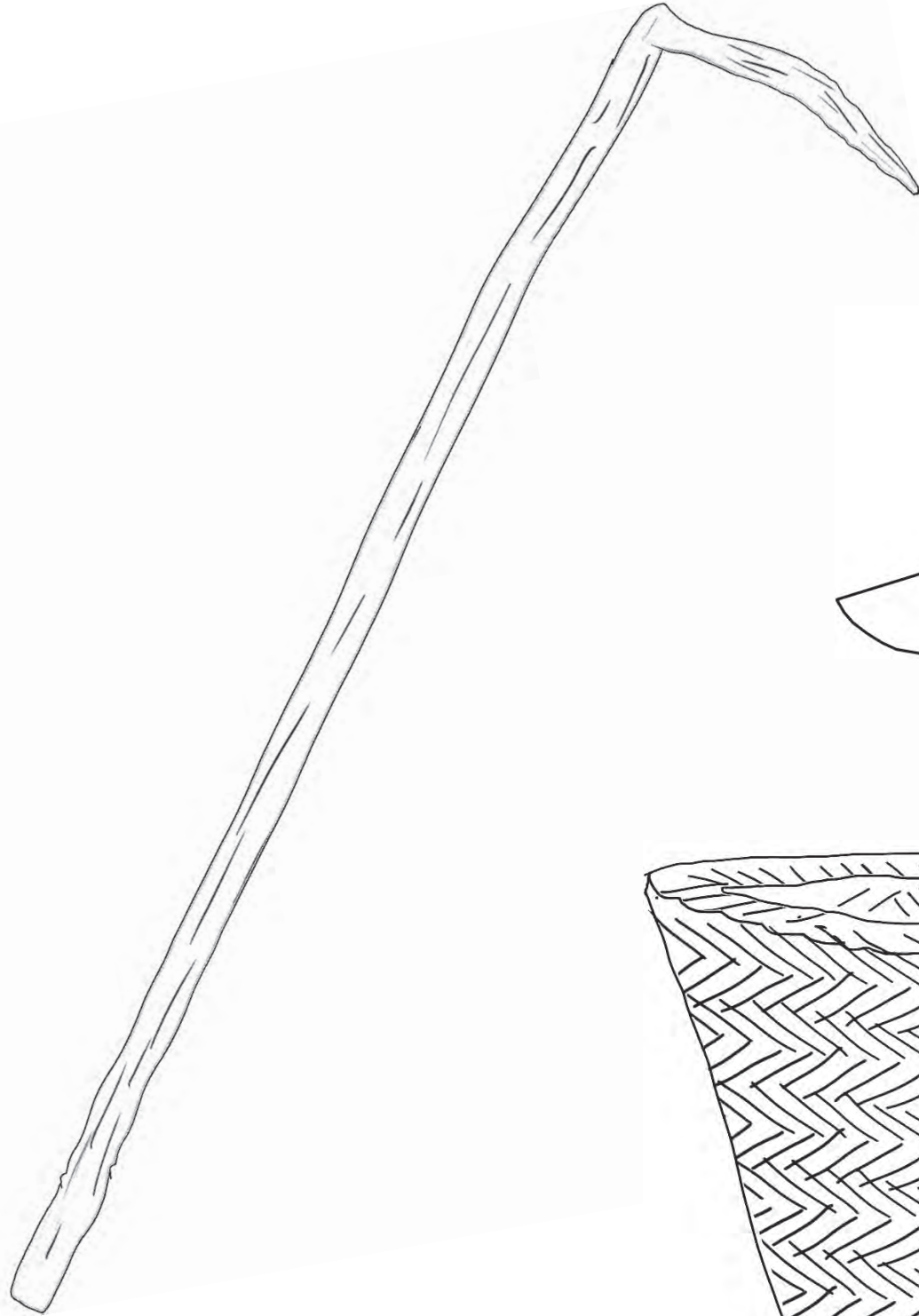

Chauega:

Nüxü tacuaxgü i ngemaüügü i nawexeü ega oriexwa i ügu

Nguexëteruü nagu i ü

Düxetüwa taxī nagu tañücawexegü i orixarü buxu.

Nachiga tidexagü i orixarü buxruü.

Buxügü nüxü nixu nataxcüwa name rü ñuxäcü namaxā i buxeta.

Wüxigu nananu i taxü rü iraxü, rü tamenaxü rü ixramenaxā.

Nanayaxu i poperaatü puracüruü rü naüxchicünaxā i noxrü gú.

¿Texegü tüxü tarügüxeé?

Buxügü rü mamagü

¿Ngexta tanaxü?

Nguepataüwa.

¿Taxcü tanaxwaxe'?

Tara, pechi, ngexri rü togüamachigü.

Wachata, tara rü pexchi rü pexchi i chauxgü.



Three horizontal dashed lines for writing.

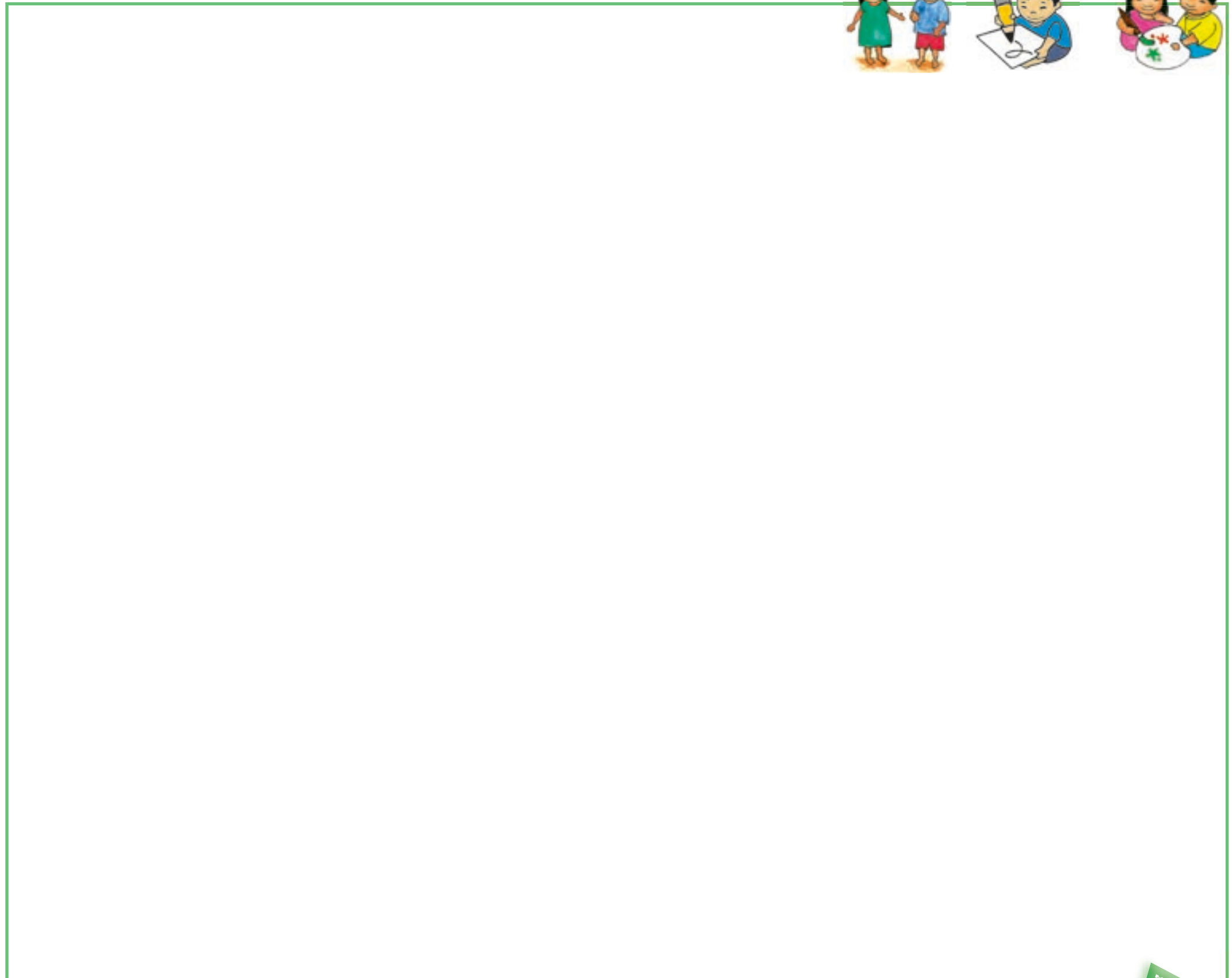
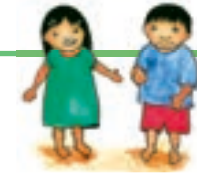

Chauega:

Taorixegü

Nguexêteruũ nagu i ü

Wüxichigü buxũ rü nachiga nidexa nañuxácü naorixegü noxrü papagümaxã.

- ¿Ngẽũrüũ orix nabuxgü?
- ¿Ngẽũrüũ nüxũ nanguchaũ?

Nguexêteruũ rü buxũgü poperaatü ta ã puracüruũ.

Büxũgü rü meãma nüxũ narü daunü rü nachiga nidexagü i ngẽma nüxũ nadaugü.

Nguexêteruũ ca ta ü.

Nguexêteruũ buxũgüna poperagu cagü ta ü.

Nguexêteruũ rü cata ü.

Nguexêteruũ rü poperaatü nüxna taxã cagü nawá ngẽxma.

¿Texêgü tüxũ tarüngüxeẽ?

Buxũgü, oxí, rü noxẽ.

¿Ngexta tanaxü?

Naãnewa.

¿Taxcü tanaxwaxe?

Tara, pexchi, ngexri, bachia, toamachigü.

Meãma naxchicünaxũ nadawenü rü nüxũ nixu i ngẽma nüxũ nadau.



Three horizontal dashed lines for writing.

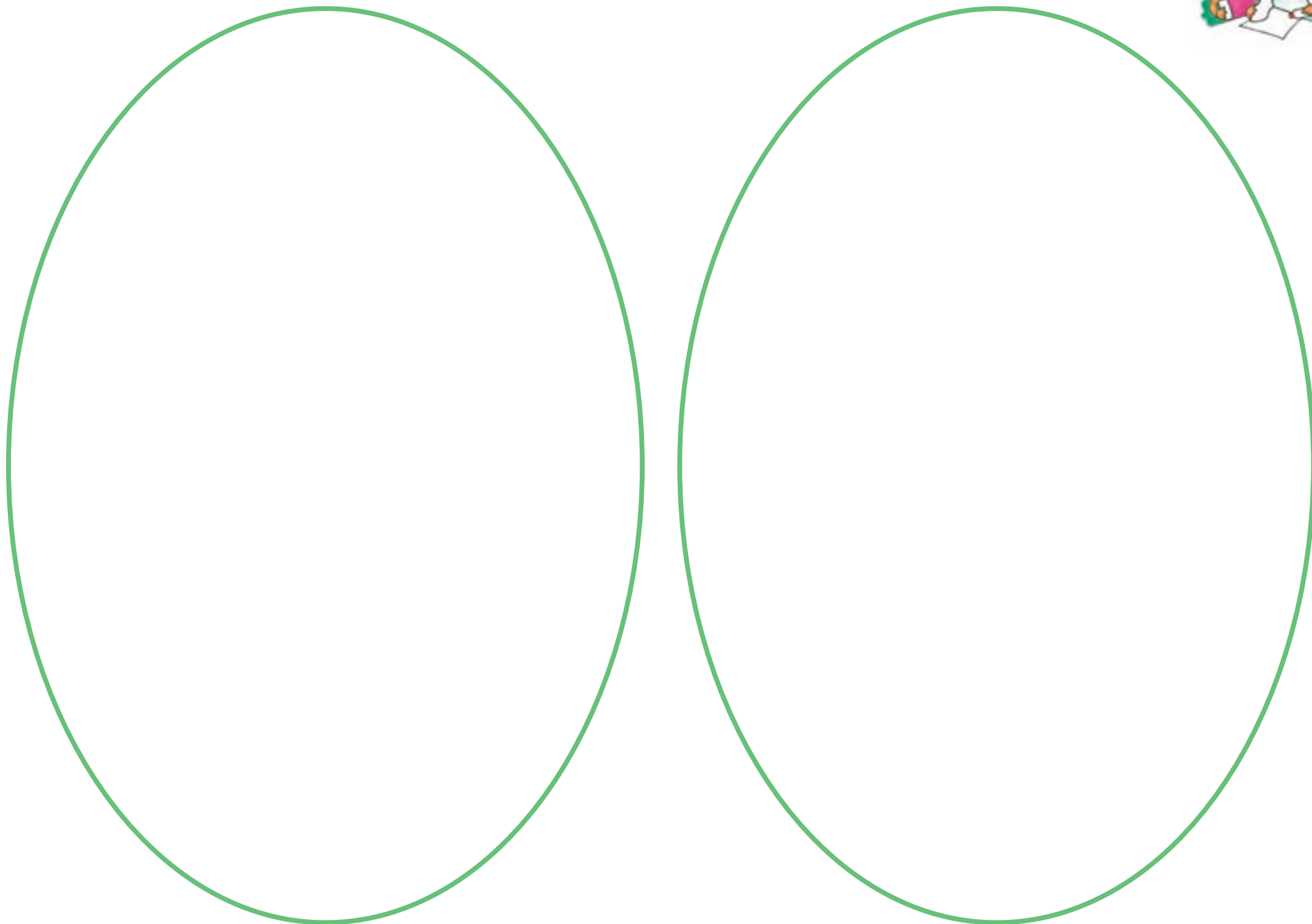

Chauega:

Wüxigu nanu i nanetü i marü idexechü

Nguexëteruü nagu i ü

Ñuxäcü tapuracü.

Itachoxü ìxätüwa taxí nagu
tainücawexegü orixarü buxgü rü nawena
nachiga tidexagü.

Nüxü tarü daünü nanañuxgüraü i
naëgagü ngëma ngëgumataä i ngõx rü
namaxä inguxü, rü maxicura, nguchia
rü tuxuä. Nguxüma ngëma i dexechi
nachiga i ü.

Guxüma ngëma i dexechi nachiga i
dexa.

- ¿Tapuracüe popera i puracüruüwa,
tanangaxü i cagü?
- ¿Ngëma marü i dexechiüwa
ngëtanixí na mumaë i orixgü rü
ngëta narü noxremaë, wüxí orix,
exna tauma?

Naxchicünaxä i orixgü.

¿Texe tüxü tarü ngüxë?

Papa rü mama.

¿Ngëta i puracüe?

Nañewa, ìxätüwa, nguepataüwa.

¿Taxcü tanaxwee?

orixchicünaxägü.

Wüxiwa nañaxcu i orix nanügügüraü.



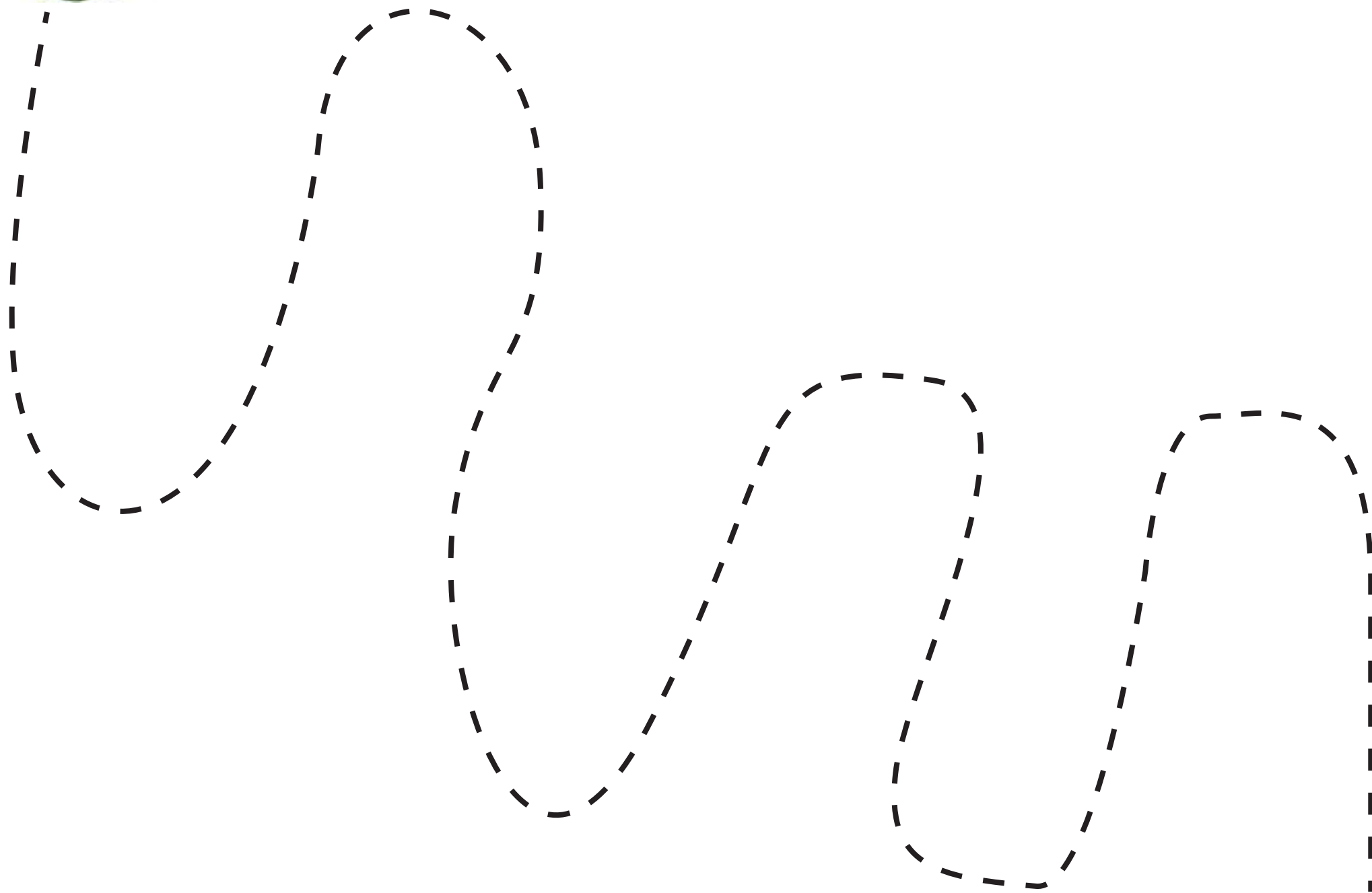
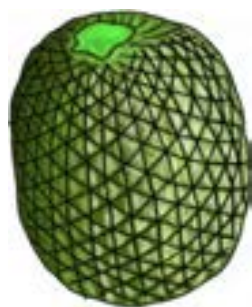

Chauega:

Temaarü doxpüxearü ñücaxwexe.

Nguxëteruũ nagu i ù

Guxũma i buxũgü rü düxetüwa naxĩ temaarü doxpüxũwa.

Nguxëteruũarü ngüëmaxã nawëpüxügü.

Namaxã nañücawexegü i ngëma noxrü temapüxüarü a Wexgü.

Buxũgü rü meãma nüxũ narü daunü ngëma noxrü ñücawexeruũ.

Nguxëteruũ buxũgüna poperaatü taxã cagümaxã.

¿Texégü tuxütáringüxé?

nguxëteruxũ rü buxũgü.

¿Ngexta tanaxü?

Íätüwá rü nguepataũwá.

Buxũgü i ägümücüarü taunecüaxũ rü nanaümagügü.





Naxca ta ngue i
taxũarũ wiyae
Pa 🍎 cumexẽchi
rũ cudexpũxũ

Chauega:

Taxüarü wiyae

Nguexëteruũ nagu i ü

Nüxũ tarü daunü i nguexëteruũ tüxũ wexũ inaxchicünaxā.

Nüxũ niuxchiga i naxchicünaxā rü nügümaxā nüxũ niugü i noxrü inügü.

Nguexëteruũ nüxũ tanawex i wiyae. Tawiyægü taxüarügu; ngēmawena taxreguchigü.

Nachiga tidexagü i wiyae.

- ¿Ngëxta mayima i taxü?
- ¿Texe tanato?

Tana ngāxũ i cagü.

- ¿Ngextá nangëxma i taxü?
- ¿Texé tanato?

¿Texégü tüxũ tarüngüxeē?

Noxē rü buxũgü.

¿Ngextá tanaxü?

Nguepataũwá.

¿Taxcü tanaxwaxe?

Taxüarü wiyae.

Buxũgü nügü naügü wiyae.



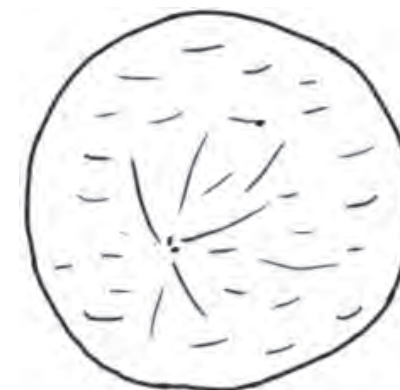
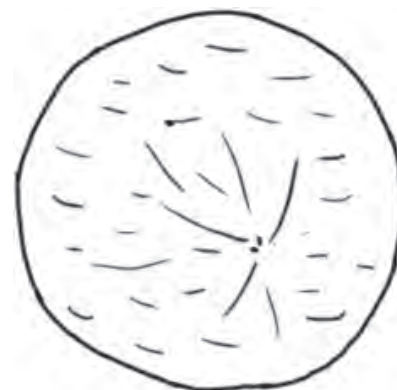
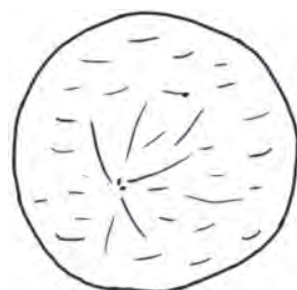
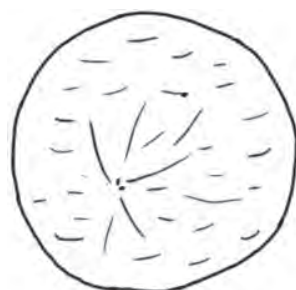
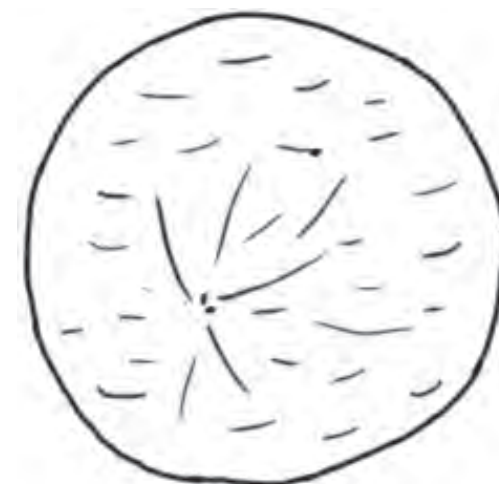
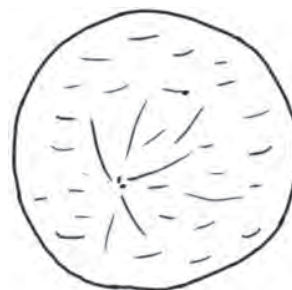
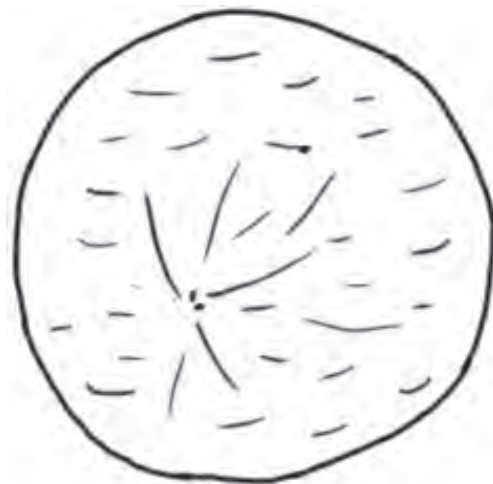
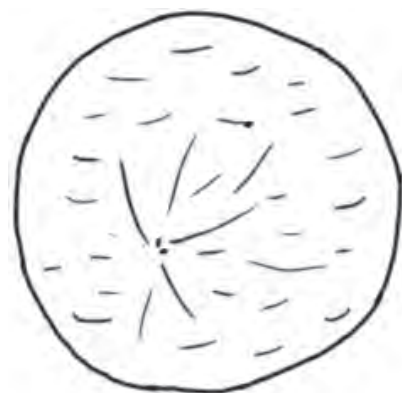
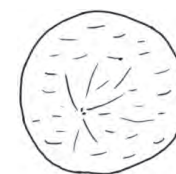
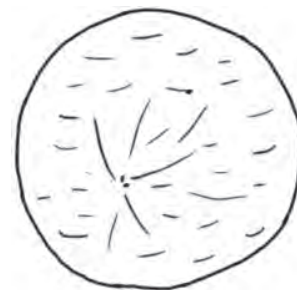
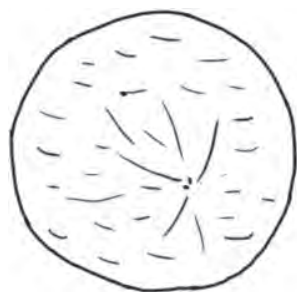
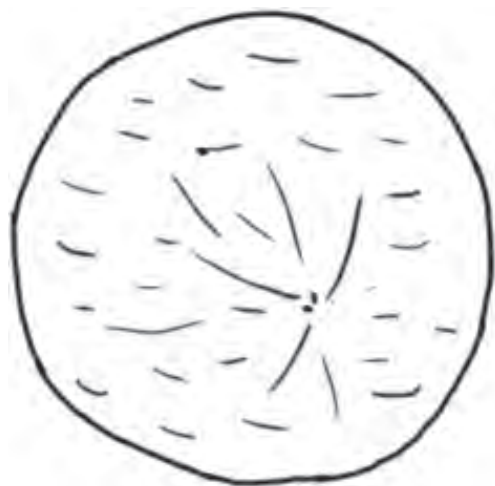

Chauega:

Wairachiremaxā taīnūcawexegū

Nguexēteruū nagu i ū

Īxātūwa taxī rū nguexēteruū tūxū
tanawex i wairachiregū.

Taīnūcawexegū nexgūtexeewa
wairachiremaxā.

Tanaū wūxi bopūxū ĩaxtūwa
naīnexgūtegūxūcax, nangucuchiūcax i
bopūxū.

Wūxichigū i buxū rū nananexē, nūxū, nixu
nangexta nangu.

- ¿Ngexta tana ū? ĩxātūwa!
- ¿Taxcū tanawexe?

Naxchiregū waira rū boruaxchire.

¿Texēgū tūxū tarūngūxeē?

Nguexéteruū rū buxūgū.

¿Ngexta tanaxū?

Nguepataūwá.

¿Taxcū tanaxwaxe?

Wairachire.

Buxūgū aixepegu naxchire tūxū nanexcuchi.



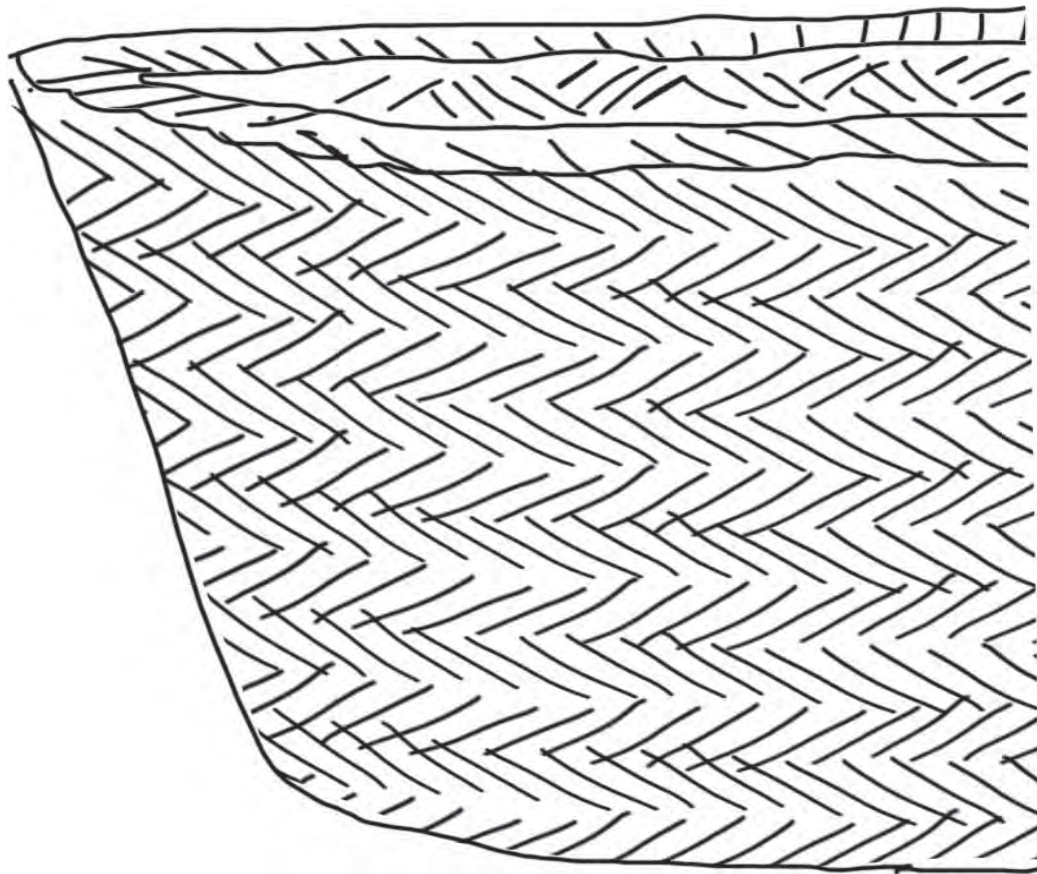

Chauega:

Taxcū tanawexe wairarū buxwa

Nguexēteruū nagu i ū

Nguexēteruū nūxū tanawex i waira rū
nūxna taca ¿Nuxācū tacawe i waira?

īxātūwa taxī natamaxā nūxū tiuxūcax
nañuxgu i wairaeū. Ngēxguma i
nawairaexgu tiuacūxū.

- ¿Taxcū i towa tūxū name i waira?

Nguepataūwa nachiga tidexagū i oxi
tamaxā nūxū i uxū.

¿Texe tūxū tarūngūxē?

Papá, oxi, noxē, tutū

¿Ngexta tanaxū?

Diuxchitawa, īāxtūwa.

¿Taxcū tanaxwexe?

Tara, yuema, nuta, purre, weruma.

Angēe i pexchi wūxi yatū naxwexe ngēxguma nawairaegū.



Three horizontal dashed lines for writing.

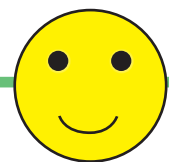

A large, empty rectangular box with a green border, intended for drawing or writing.

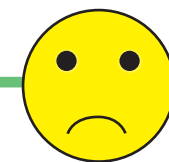

A large, empty rectangular box with a green border, intended for drawing or writing.

Chauega:

Óxrigü choxü mexü

Nguexëteruũ nagu i ü

Ngueëtaeruxü ägümucü i ixri pexchigu inange.

Taxre i buxügü rü ninaixetü ñumachi nüxü niu nataaxcü atü oxri yixi. Ngëma nüxü a yaxächü nüxü, ngüxü nüxüna.

Togüama i buxügürü meáma inarü inuë.

Ngëxgumawena i buxü rü nüxü nangõxnetä, naegaü, niugü.

Ngëxgumawea i buxügü rü nüxü nangõxnetagü, ñaegaü, ningü nanüüca, nanañuraü, nañuxmatüraü.

Wüxichigü buxügü nüxü niuxgü oxri i nüxü meëxchi, tama nüxü neü. Nümachi nüxü niux, taacurucü nüüname.

Puracü nüxü ü ägumücügüarürüxü.

¿Ngexta tanaxü?

Nguepataüwa

¿Taxcü tanaxwaxe?

Pexchi, 4 oxri, maixcura, 1 nguciax, haxchicünaa, nanguraü.

Naüxchicünaxä rü nachaxu i orix i cuxrü meixi rü tama cüxrü meixi nachiga i ú.





Chauega:

Wairachixī Tataxū

Nguxēteruū nagu i ū

Wüxie mamana taxu nawairachixī ta ū.

Nüxū tarū daunū nañuacū nanaüchixū
i waira, ngēxguma marū namexgu rü
bachiaгу tanagü.

Nüxna tacuaxāchi naīyauxmegü
nanaüxūcax i wairachixī.

Nguxēteruū namaxā nüxū tixu i
wairachixū namaā i ū.

Tacari rü camüteruū.

Tanacamüchara, tanachachixī rü tana
yoxpetü i waira.

Ngexguma marū naguxgu i noxrü ū, rü
nanachiga tidexagü ngexgumawena
taaxgü.

Texegü tūxū tarü ngüxē.

¿Taxcü i ngēmaüğü tanawexe?

Ngaxwe, tachaü, axeruü.

¿Ngexta Tanaxü?

İpatawa.

¿Taxcü tanaxwaex?

Bachia, panera, ngaxwe.

Itañaxcuchi i wairachixī namaxā ixü.



Three horizontal dashed lines for writing.



Chauega:

Nachiga tidexagü nguxüma i puracügü

Ñuxacü tapuracü

Taboxchimaügü i nguxëma nangemaxäcü yigü i inüëücax.

Guxüma i puracü tawemacü i tupanachigu i ü .

- ¿Nguexëteruñarü ngüxëmaxä tanangaxü i cagü?
- ¿Taxcüarü puracü taxü i tupanachigagu?
- ¿Texe tuxü tarü ngüxë?
- ¿Ngexta netaxí?
- ¿Toxrü popera i puracüruüwa tapuracüe?

Nawa tapuracüe i ngëma nüxü a ú.

Guxüma puracü i tupanachigagu i ü. Nüxna nacuaxächi nataxcü cuxü, tapuracüe ngechaxüäcü. Tanaüxchicünaxä, nachaxu i ngëma chanaxwexeüchi.



Three horizontal dashed lines for writing.





Ngue rü
naexmümmüarü ü

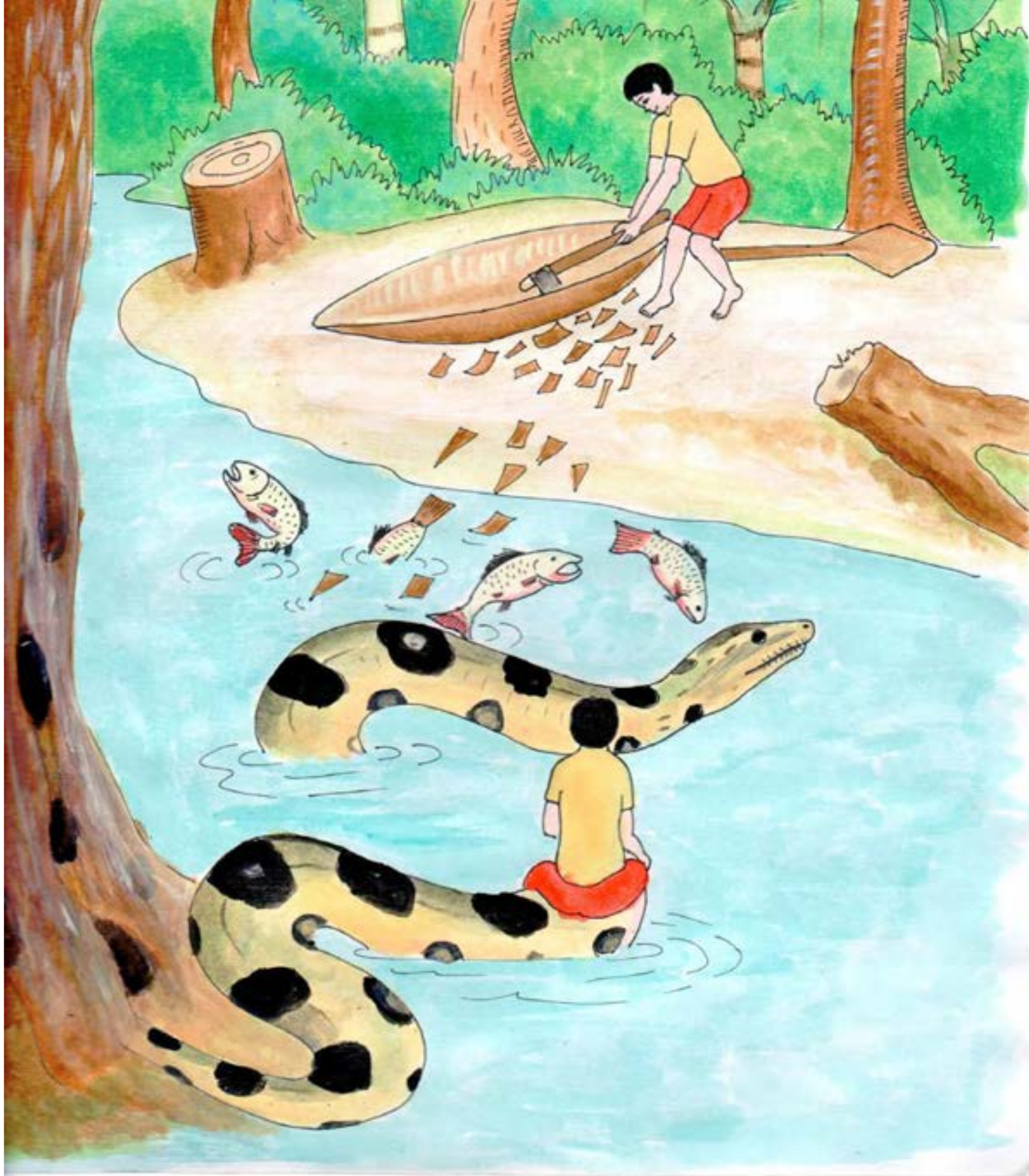

Chauega:

Ngexta nangox i nguechiga

Nguexëteruũ nagu i ù

Taxcü naüğü i buxüğü.

Tümaütawa Taxī ya nüxü cuaxe natamaxā nüxü tiuxücax nangexta nangox i nguechiga.

Taxregu nügü niyauxyechimaüğü rü nüxgümaxā nidexagü nachiga nangexta nangox i nguechiga, nagaxü i cagü noxrü dexamaxā.

- ¿Ngeürüxü i naīwa tanaü i ngue?
- ¿Tüxcüruü nixī i tama guxüma naīgü nguewa name?

Nguepataüwa nachiga nidexagü.

- ¿Ñuxre ngumexü tüxü ningü ya ngue?

Nguexëteruũ tanaümatü i ngäüğü taatüxü i poperagu.

¿Texe tüxü tarüngüxë?

Õxī, papa, mama noxë.

¿Ngexta tanaxü?

Oxipatawa, nguepataüwa.

¿Taxcü tanaxwaxe?

Taatüxü i popera.

İnañaxcuchi i naxchicünaxā ngëta inangoüxwa inanügügüraxü.



Three horizontal dashed lines for writing.

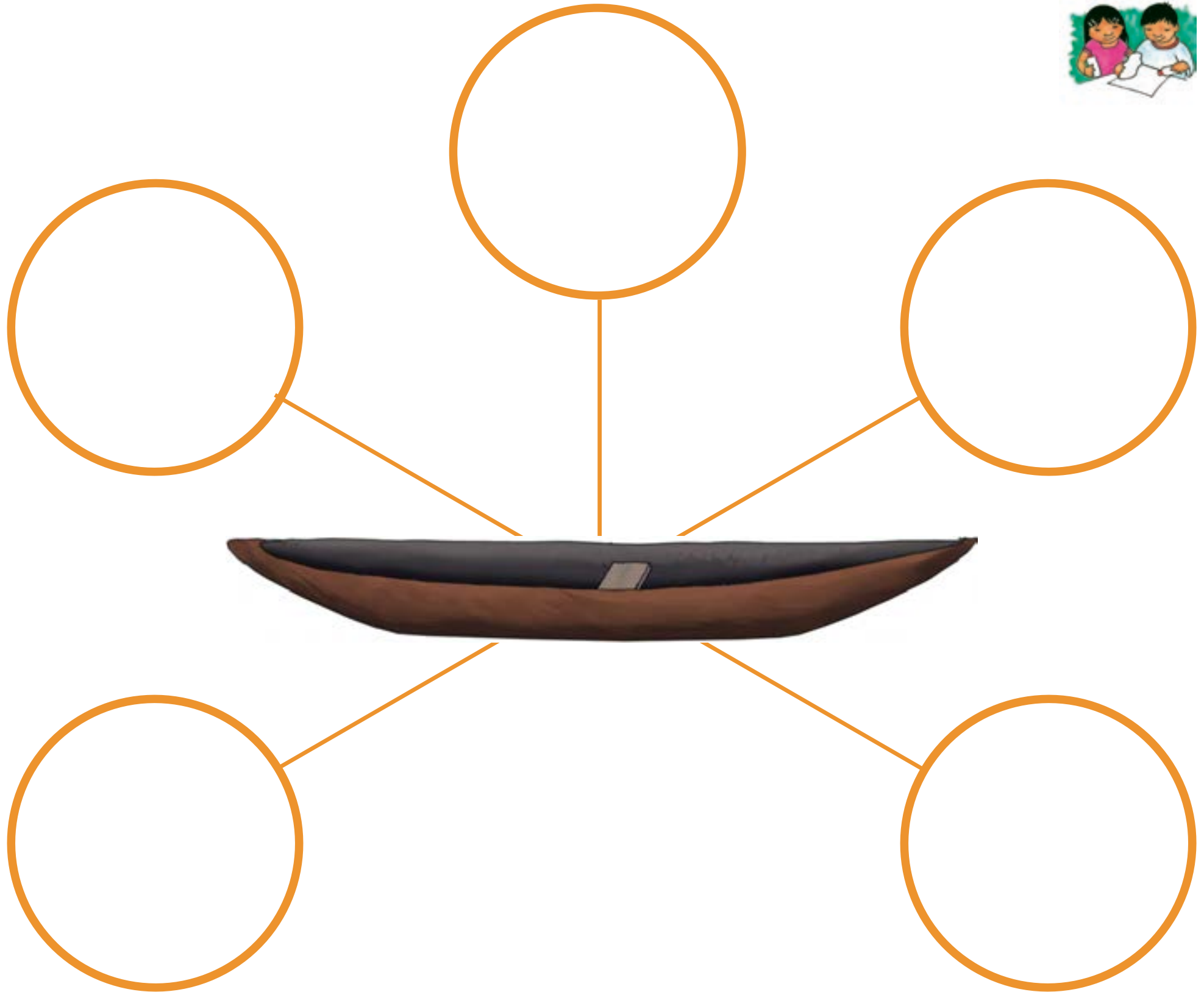

Chauega:

Nüxü tarü daunü i nguearü ü

Nguexëteruü nagu i ü

Nüxna tacuaxāchi rü tadaumatütegü,
nguexëteruüarü ngüëmaxā nüxna
tacuaxāchi nacüma i meü.

Itachoxü rü tarü daunü i nguearü ü.

Nguepataüwa taxī, nachiga tidexagü i
ngëma nüxüarü daunü.

Nguexëteruü rü nachiga, tidexagü | noxrü
mexü ya ngue.

Tapuracüa puracürüwa.

Poperaatü i puracüruxü.

¿Taaxcü i ngæmaxü tanawaex?

Yuema, nuta, naixnüta, purure, weruma.

¿Texe tüxü tarüngüxë?

Papa, oxi, noxë, tutü.

¿Ngexta tanaxü?

Dauxchitawa, ïäxtüwa.

¿Taxcü tanaxwexe?

Tara, yuema, nuta, purre, weruma.

Ngexta nachicawa inañaxcuchi i wüxi naxchicünaxā puracüruxü.



Three horizontal dashed lines for writing.



Chauega:

Nguegu tiweũtaũ

Nguxeteruũ nagu i ũ

Nũxũ taarũ dauxnũ ya ngue i natũacũwa ngẽxmagũne.

Ta woegu i nguepataũwa rũ nachiga tidexagũ nangue arũ dauwa ne i ĩ

- ¿Cogũ?
- ¿Taacũtũxũ name ya ngue?
- ¿Teex namaã taxuac?

Nanayaux i paperuatũ i puracũruũ.

Wũxĩ bachiax maã ããxcu l dexawa tamangũeẽ, ngexguma taxtũ l naxtũacũ nayaũgu.

Nawamanagũeẽ l nguexchicũnaã poperaatũwa ũxũ, natũaxcũ y exna inagaixcamaũwa i dexa.

Nũxũ taarũ daunũ ñuãxcũ a ngũchigũ dexawa.

Ñuxmachi ñuãxchi paax ngexta nangũ.

¿Texe tũxũ tarũngũxẽ?

Buxũgũ ngueẽtaerũũ.

¿Ngexta tanaxũ?

Natũacũwa.

¿Taxcũ tanaxwexe?

Bachia nguechixũna.

Wũxi ngue naũ poperawa rũ nũxũ i u naũuãxcũ a ngũchigũ.



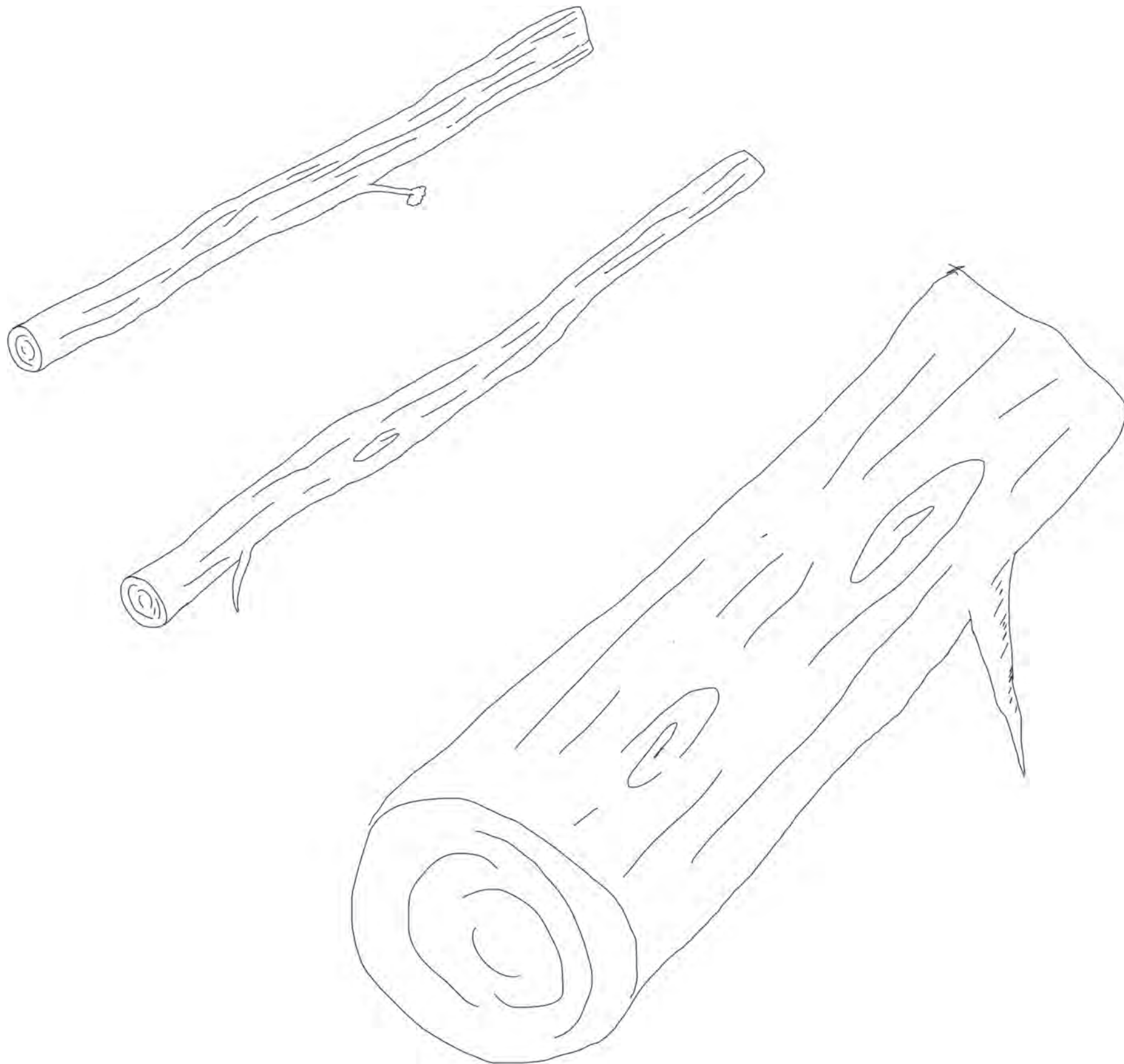

Chauega:

Nüxü tacuaxchaũx i inañuxraũ i naĩ nguewa meũ

Nguexëteruũ nagu i ü

Itachoxũ i nguepatũwa rü düextüwa taĩx, itadaúx i naĩ ngaixcamawa ngemaũ i nguewameü.

Tawoegu nguепатаũwa rü nachiga tideaxgü ngexma nüxü i dauxnü.

Tanangaũ i cagü

- ¿Nana nüxgüraũ i nai i nguewa mexü?
- ¿Nañugüraũ i naĩoü nguewamex?
- ¿Nangëmaxũ nguëpataũwa i naxëmüraũ?
- ¿Nüxca pedaxü i ngëmaxü i wichipax r exna äũa?
- ¿Nanuxguraüne naxëmü nayima?
- ¿Naxcax Pedaux i ngëmasxü ina itaxcurüxraũ?

Nanagügu üna ëxtacuxrüraũ maya naxëmü.

¿Texe tüxü tarüngüxë?

Buxügü nguëëtaerüũ.

¿Ngexta tanaxü?

Natüwa.

¿Taxcü tanaxwexe?

Poperaatü.

Inawüxe i naxchicünaxä ngëma namaxä wüxigu rü nachaxu.





Chauega:

Waira arü nguemaxã ta inücawaexgü

Nguxëteruü nagu i ü

Nawa naī i wairapaü i
nangaixcamaüwa.

Namaã inücawaegü taxrechigü I waira
wairapaü.

Nachiga tidexagü I inacawaex.
Tanangãü.

I cagü

- ¿Ngexta nixī I napeex rü
naweama?

- ¿Naetüwarü exna ñaxtüwa?

¿Texe tüxü tarüngüxë?

Mama rü buxügü.

¿Ngexta tanaxü?

Naguepatawãxtüwa.

¿Taxcü tanaxwexe?

Naxchicünaãx, warapaü.

Nachaux i naxchicünaxã i napexewa ü. Inaboeügu I buxü. Naweama ngexma.



Three horizontal dashed lines for writing.

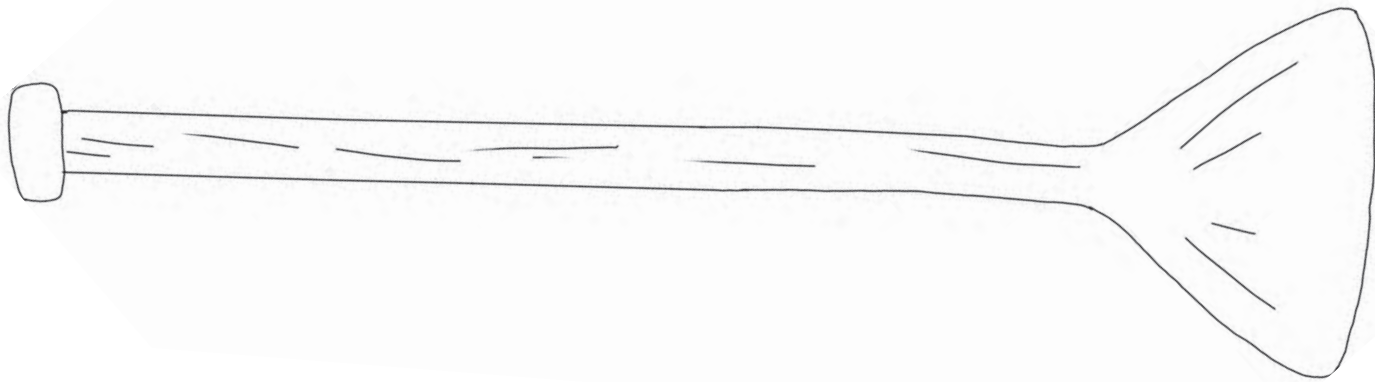
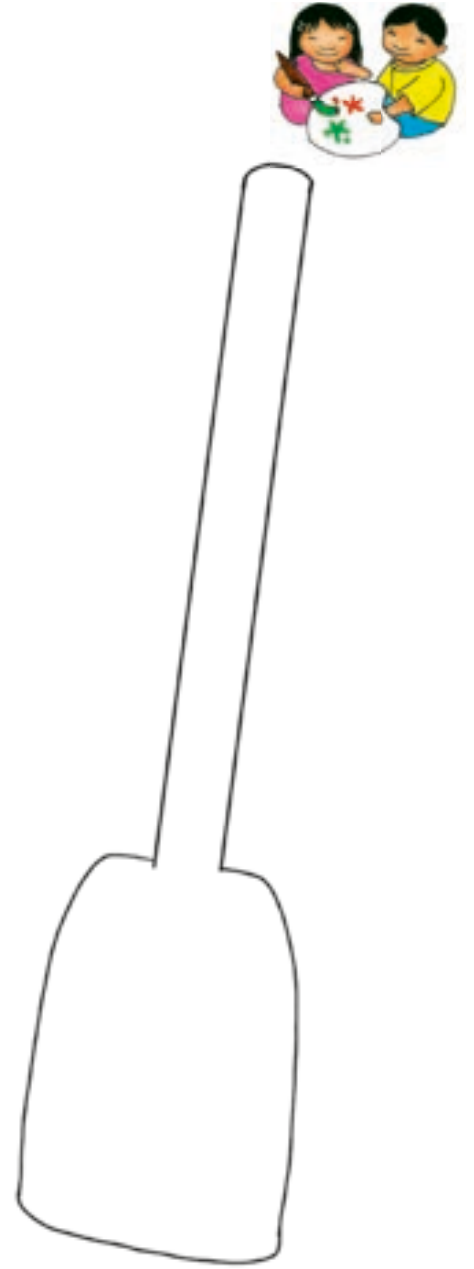
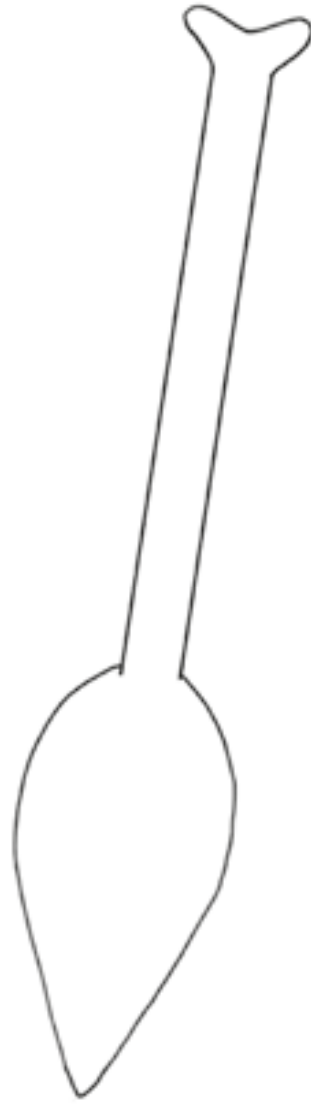
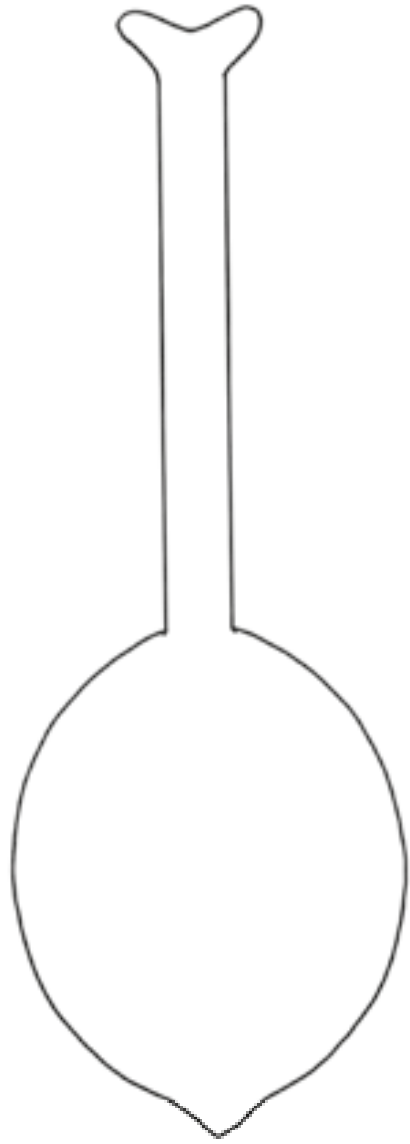
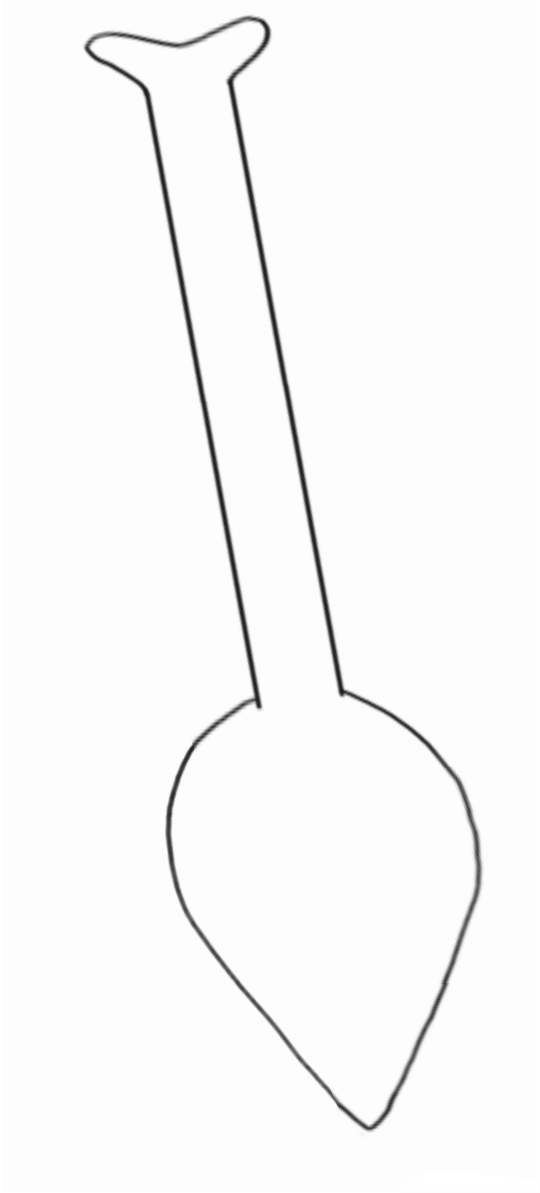

Chauga:

Nguũxraũne ya naẽxmũ

Nguexẽteruũ nagu i ù

Tũrewa l taaduxgũ, nũxũ taarũ daũgũ ya ngue rũ ñuxmachi ngue taũnewa ngẽxmagũne ya naẽxmũ.

l ãxchimũãxcũ rũ wũxigu tanonu ya naexmũ nũxũ a uãxcũ yima a nũgũgũraũne. Nataaxcũwa nameũ wuxichigũ. (Chaxniẽruũ, ãruxũ, ngoxeũ ùguruxũ).

Nguepataũwa nachiga tidexagũ:
Ñuxmachi naxchicũnaxgũ i naexmũ.

¿Ngexta tanaxũ?

Nguepataũwa.

¿Taxcũ tanaxwexe?

Popera i puracũruũ naxchicũnaagũ, chauxtaeruũ.

Tachauxgũ ya naẽxmũ ya yima choxnieruxũ.



Three horizontal dashed lines for writing.

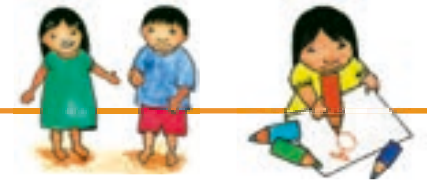

A large, empty rectangular box with a thin orange border, intended for a drawing or illustration.

Chauega:

Tana ü ya naexmügü

Nguexëteruü nagu i ü

Nüxü narü dauxnü i na nguxüraüne i naexmü.

Ngue i tañnewa ngëxmane.

lãxtüwa naexmümaã
naïxnücawaegü.

Nguepaũtaũwa nayauxgü.

Nügümaã nüxü niugü nügümücumaã
naxñacü namaã i cuax ya wüxichigü ya
naexmü.

Papá arü ngüexmax naexmü neüügü
punewa.

Nüxö niúx nüxö name i naexmü, rü exna
tama.

Nachiga nidexagü taaxcüwa tuxü

namexü ya naxëxmü.

¿Texe tuxü tarüngüxë?

Oxigü papa buxügü.

¿Ngexta tanaxü?

lãxtüwa nguepataũwa.

¿Taxcü tanaxwexe?

Pune, tara, naxñüta.

Nachaxu ya naëxmü yima cuxü mexü ega tacuyaxgu.



Three horizontal dashed lines for writing.

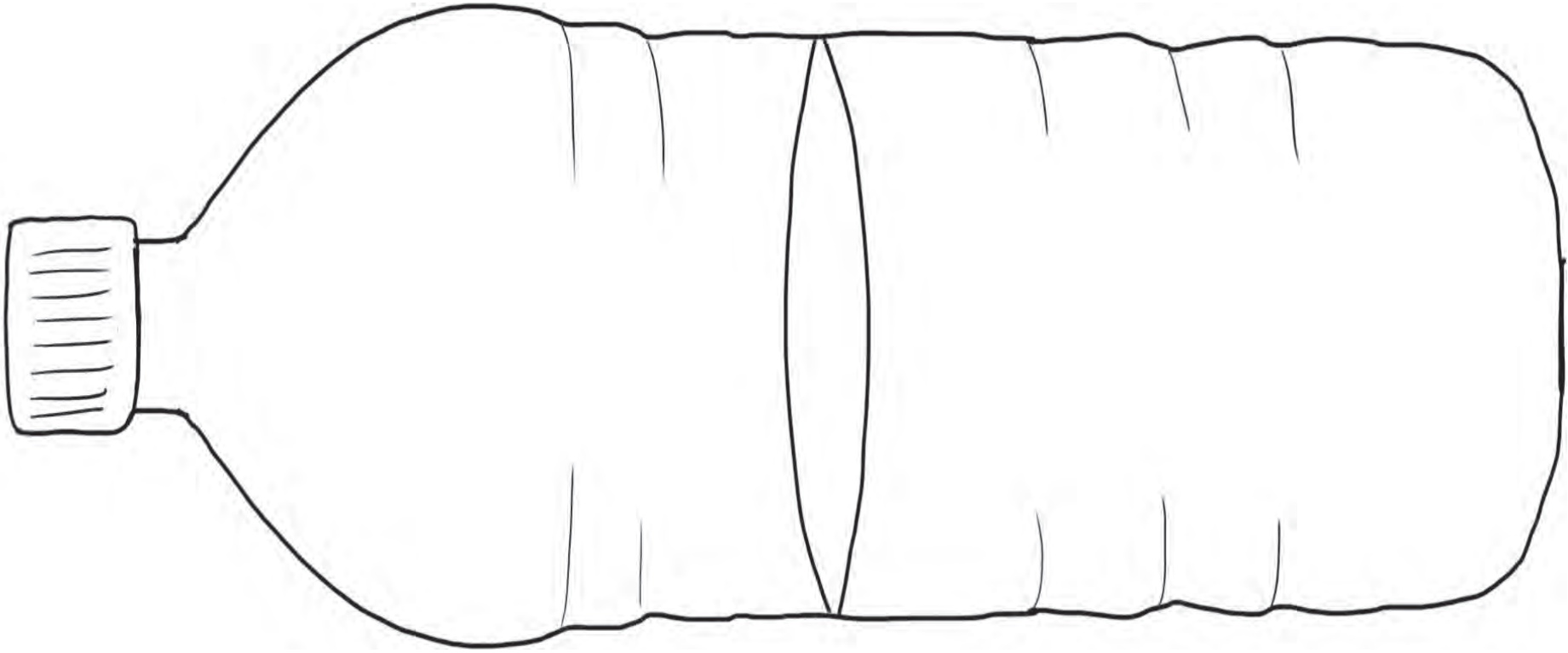

Cuxmaca nextaügü

Nguxêteruü nagu i ü

Ngemaüxgüxü taarü daunü mamagü nua ngexü nguepataüwa, nana üücax i cuxmaca.

Tanangaü i cagu

- ¿Taacüwa tana ü?
- ¿Ñuaxcü tana ü?

Tana ü ya cuxmaca yatüxügü tanixi ngëxma ngëxmagüxü, ngueugu natama. Dexa tuxma naäguimare.

Nüxü tarü daunü nax cuxmaca iu tamaixtuxügü, namaxä tanguügü butillagü.

¿Texe tuxü tarüngüxë?

Papa, noxë, oxi.

¿Ngexta tanaxü?

läxtüwa

¿Taxcü tanaxwexe?

Tara, pomüruüx, ngaxwe.

Inanäxcuchi i naxchi cünaxä i ngemaëgü ngëma namaxä naxü.



Three horizontal dashed lines for writing.

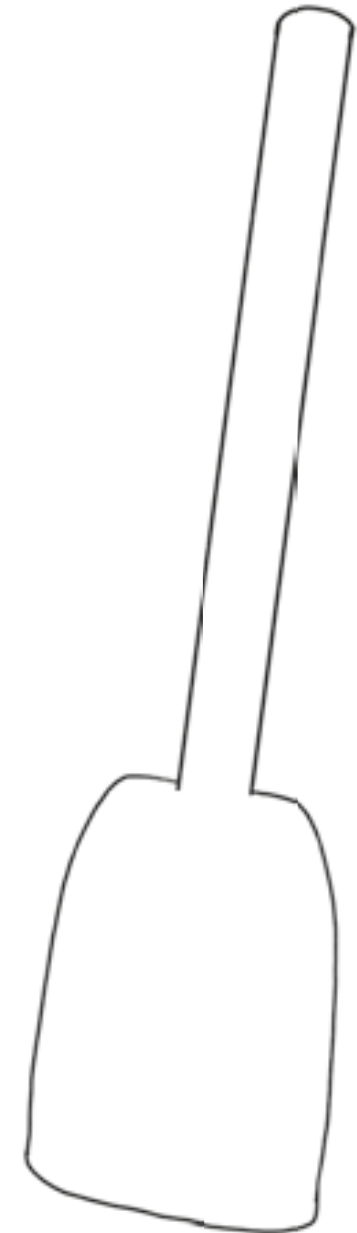
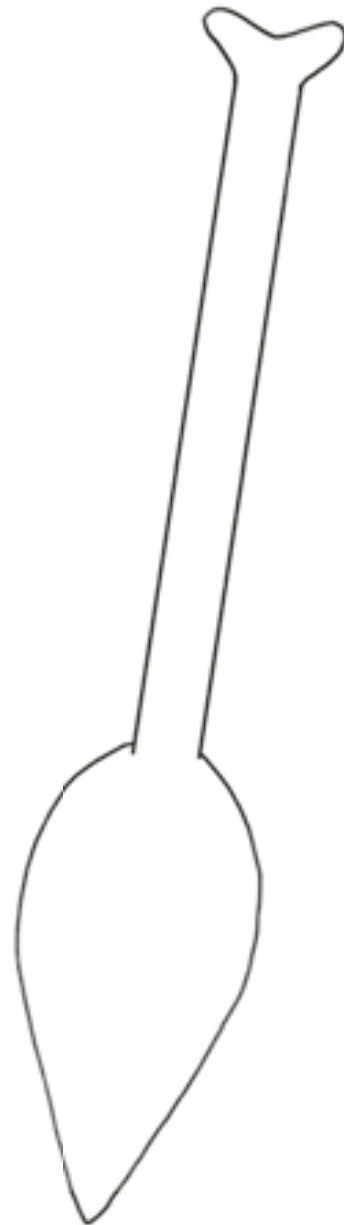
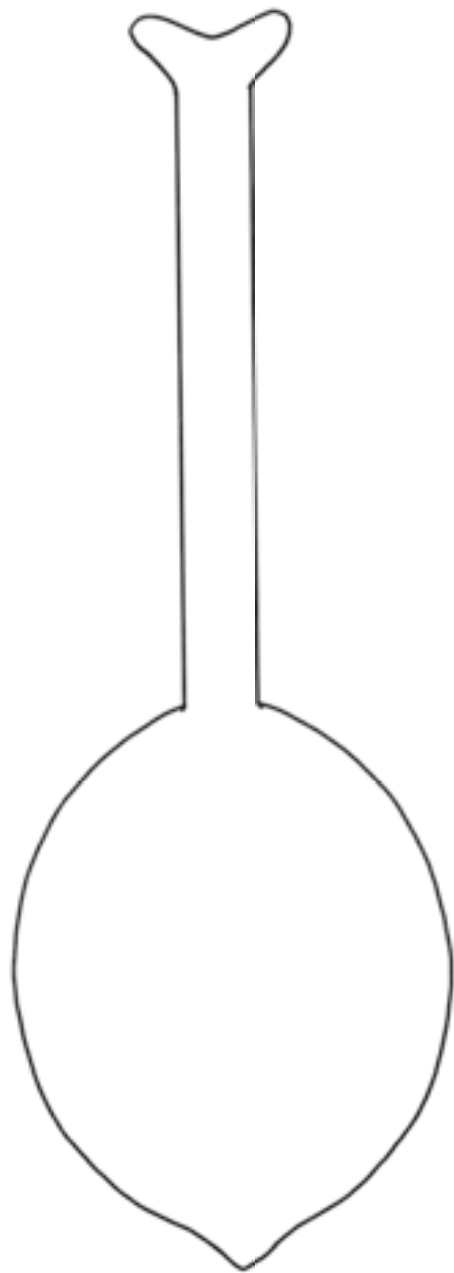

Chauega:

Tachauxgü i toxrü naëxmü

Nguexëteruü nagu i ü

Nachiga nixi dexagü i naigü i naxëxmü wame rü ñuxmachi nüxü narüdaunü ya naxëxmü i nguëpataüwa nanagüne, ngëgumarüü i ngëmaügü nawaxeü nawa i naxemü a rü chagü.

Nanangaü i cagu ¿Taxcü nangupetü ngëguma nagu nawayagügu i tanimaca?

Nachiga nidexagü i naxëmü arü egü. Nüxü nangëma i noxrü chuxüü

- ¿Taxcü rüü?
- ¿Teëgü a egüe?
- ¿Taaxcü rüü i buxü i ngeü tama naxëxmüni egü?

Tüxü narü daunü ya oxi nüxü cuaxe rü nawena nanarüdaunü rü nüxira taarü naægü ya naxë mü.

Ngexügü i buxügü rü nüxgü naüchapaxa nanaüxchicüxnaxgü ya naexmü taüxü i poperaatügu, nana ügü wücumaügü.

Nüxü piüx naxtacüwa nameüx ya naexmü.

¿Texe tüxü tarüngüxë?

Buxügü. Nguexë teruü.

¿Ngexta tanaxü?

Ngueëpataüwa, ipatawa.

¿Taxcü tanaxwexe?

Poxiatü naxüü cuxmaca, naxëmü, tanimaca.

Namexcüraü ya naëxmü.



Three horizontal dashed lines for writing.



Chauega:

Ngue rü naexmüarü inücawex

Nguxëteruü nagu i ü

- ¿Taacü na üe i büxügü?
Nguewa na naixnacawaexgü, naewa na taxtüwa nangexmagü, nichoix rü tocüwawa naix.
Nanayauxgü i noxchicünaã ya naexmü rü ngue.
Taxrechimüüxi naügü wüxichimü i ngue. Toxhinmüü i naexmü
Nügücax naix taxre chigü, ngue rü naexmü naïnücaweagü rü ngemacü naix, taxtüwa, nãcü.

Buxü ngue: Ngue niña.

Buxü naexmü: Naexmü niãx.

Naïnü cawaexgü i buxügü naxchica i taanüwa nüixcagü.

¿Texe tüxü tarüngüxë?

Nguxëtaruü.

¿Ngexta tanaxü?

Nguepataüwa.

¿Taxcü tanaxwexe?

Naxchicünaã.

Nanachauxgü i nguechicünaxã.





Chauega:

Nachiga ti dexagü i nguxüma puracugü

Nuxacü ta puracü:

Ta boxchimüxügü i nguema nangemaxäcü yigü inüëñcax
Nguxüma i puracü i tacuemacü i tupanachiga.

- ¿Nguexëtaruxü arü üxëmaxä rü tanangäxü i cagü?
- ¿Taxcü i puracü taxü i tupanachigugu?
- ¿Texe tüxü tarü nagüxëë?
- ¿Ngexta netaxí?
- ¿Toxrü popera i puracürüxüwa?

Nawa tapuracüe i ngëma naatü puracütüxüwa nüxü a ú.

**Guxma puracü i tupanachigu i ü nüxma nacuaxächi nataxcü cuxü,
tapuracüe ngë chañäcü, tanaüxchicünaxä, achaxugü ngema
chanaxwexeüchi.**







Naanegu tatoegü

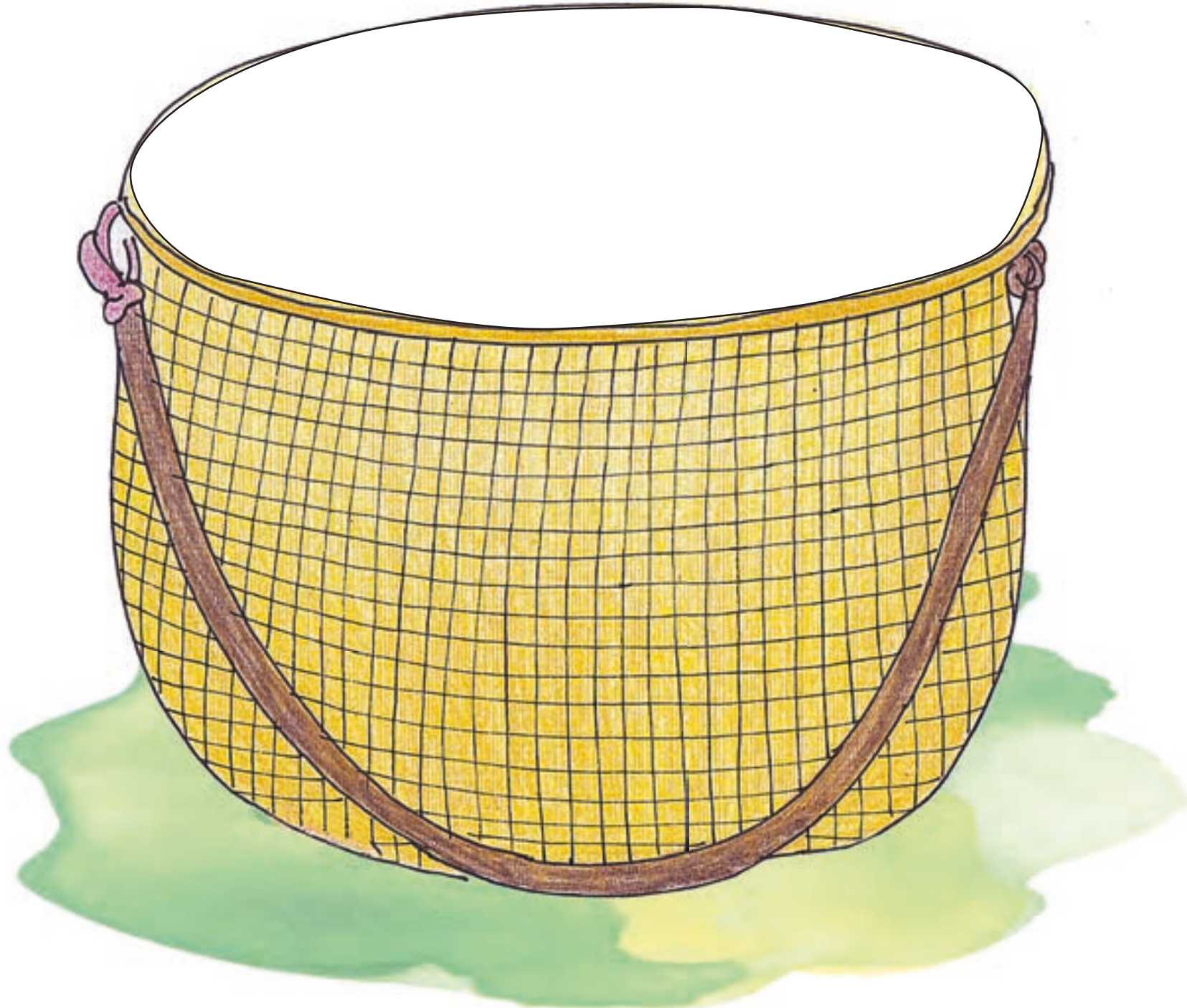

Chauega:

Ngexta nangox i naãne

Nguexëteruũ nagu i ù

Nuxcūma natauma ga naãne ñuxmarũũ. Ngëguma ga yoxi rü lpi nanawexegũ ga nanangoxũ ga naãne, yema nanamugũ ga wüxi yatũ ga naega lyaiya, rü naixnecüwa namaxũ.

Noxrü pexchi nabüxecha namaxã ga naguxũraũ ga nanetüchire. Yema rü oxí cowüchirextamani ngëxguma rü nayexga ga wüxi duũxũ ga naxcax tũxũ nangix. Rũ nawe narü cagũ: naüane rü nato ya yima tüxe rü ngëguma marü cuxũ nayaxgu rü nayüxüe.

Nguepataũarü düxetüwa naĩnücawexegũ nagu i oxí cowü noxrü pexchi rü büxüũgu.

Nguexëteruũ rü taxre buxũgũ i yatũ tinaxĩgüchametü rü ñuxmachi taxre ngexũ nüxna tanana i ngëma oxí cowü noxrü pexchigu i na.

Togü i buxũgũ rü meã i narü togü.

Ngeguma marü na pexchiyi. Rũ exna wuxi narü yi rü wuxí l uit ngueëtaerũũ rü cataü.

¿Texe tana ü i naãne?

¿Taxcūmaã naãcu i pexchi?

¿Texe tanabüxgũ ga pexchi?

Buxügu, ngueëtaerũũ.

¿Ngexta tana ü?

Nguepataũwa.

¿Taxcũ tanaxwexe?

Taatüxũ i popera, pexchi, nanü rü uí.

Nachaxu i oxí cowüchicünaxã.





Chauega:

Nüxũ tacuaxgũ i waximũgũ

Nguexẽteruũ nagu i ũ

Itachoxũ rü naãnewa taxĩ rü itange i panera waximũchiũ.

Itachoxũ rü türewa taxĩ waimũ tatayaxu rü nguepataũwa tanange i ngema taxreraũũ i waximũ.

Daupetũruũmaxã nüxũ.

¿Ngexũrũxũgu tatoe?

¿Taxcüũ nawa peda a nãã waximũ?

¿Texe tũxũ tarũngũxẽ?

Buxũgũ.

¿Ngexta tana ü?

Naãnewa rü türewa.

¿Taxcü tanaxwexe?

Panera rü daupetũruũ.

Anguxẽ i ngẽma naxchicũnaxã rü nachaxu.



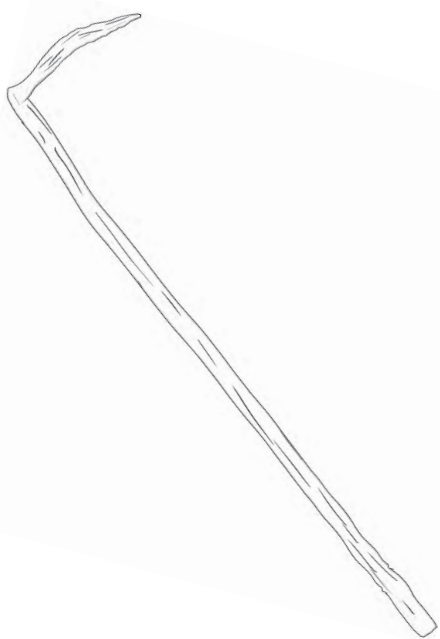
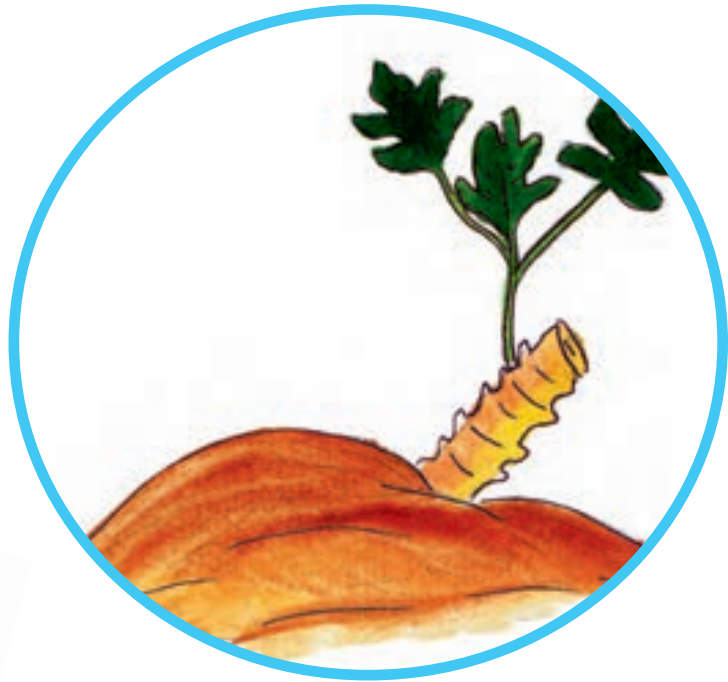
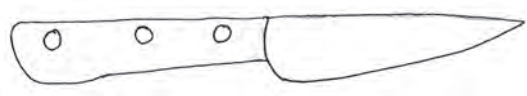
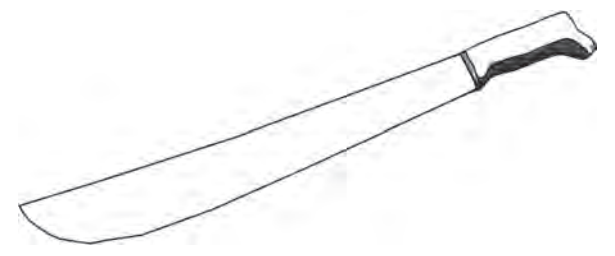
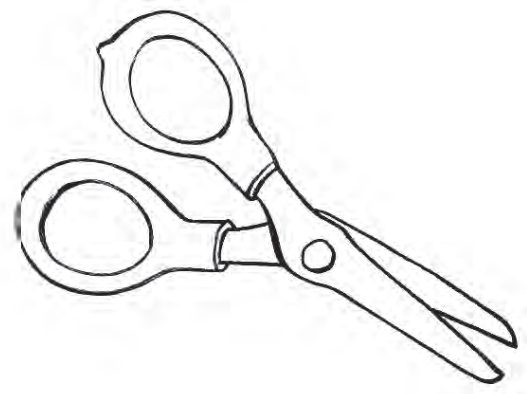
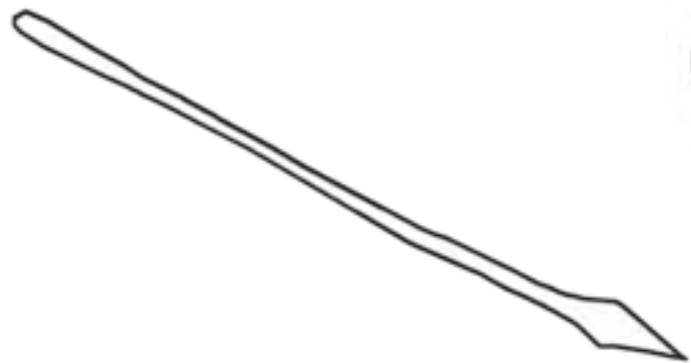

Chauega:

Tanaü i waiyuri natüxe i togüxcax

Nguexëteruü nagu i ü

Boxchimaüäcü i tarü togü rü tarü ünüē i nguexëteruü tamaxā nūxū i u nachiga i waiyuri i ü.

Nguepataüwa rü chaxū tatiaxü i nguexëteruü ngēma ngē.

Papa rü mamagüarü ngüēmaxā tanato ya tüxe.

Wüxichigü buxügü rü nügüchacügu naānatanü ya nanü i natogüchaüne.

Natoegü ñuxmata nūxū naguxgü ya yima nanü.

Tawoegu nguepataüwa.

Nguexëteruü buxügüna taca.

- ¿Taxcü naxca nixi i paieruü?
- ¿Ñuxrerüne nixi ya nanü i togüne?

¿Texe tüxü tarüngüxē?

Buxügü, papagü rü mamagü.

¿Ngexta tana ü?

Naānewa rü nguepataüwa.





¿Taxcü tanaxwexe?

Nanü tara paeieruü chaxü.

Achagü i puracü namaxā i ügüxü.





Pa chaumücü 
ina wexechi ya 
chanangõx 
rũ ñuxmachi 

Chauega:

Tana ü i nagu tuxü rü inüxë

Nguexëteruü nagu i ü

Nachiga tidexagü rü nuxü cuaxeütawa taxí.

Wümatütaeruüwa tañaxcuchi taatüxü i popera. Nguexëteruü rü buxügüna taca.

- ¿Taxcüü tadau i oxipatawa?

Nguepataügu taanu ya tuxe.

Nuxü niugü nanañuxraü ya tuxe.

Nguexëteruü rü buxügümaxā wüxigu nanaügü i wüxi nagu tuxü rü inüxü.

- ¿Taxcü mexyi yaxcü mexyi?

Pa chaumücü yuraü.

ina wexechi ya cuchacü.

chanangōx choxnimax.

rü ñuxmachi chaxüwa.

¿Texe tuxü tarü ngüxë?

Buxügü, oxi rü nguexëteruü.

¿Ngexta tana ü?

Oxipatawa.

¿Taxcü tanaxwexe?

Taatüxü i popera rü tuxe.

Nananguäëgü popera yaaümaxa i ngëma nagu tuxü rü inüë.





Chauega:

Poxire naguŭgŭraŭne

Nguexĕteruŭ nagu i ũ

Dŭxetŭwa naxĭ rŭ nanaugŭgŭ ya poxire.

Wŭxichimaŭ i buxŭgŭ nanaugŭgŭ ya poxire yima (noxrene).

Taxrechimaxŭ nanaugŭgŭ ya poxire ya maxtanŭna (muxŭchi)

Tomaĕpŭxchimaŭ taxuma nixugŭgŭ (taxuma).

Nguexĕteruŭmaxĕ wŭxigu naugŭgŭ ya poxire.

Nguepataŭwa nachiga nidexagŭ i ngema naŭgŭxŭ.

Nguexĕteruŭ rŭ cagŭ taŭ.

- ¿Ngexŭchapaxa i buxŭgŭ naugŭ i muxŭchiŭ i poxire?
- ¿Guxŭma wŭxigu i ugŭgŭ?

¿Texe tŭxŭ tarŭngŭxĕ?

Buxŭgŭ.

¿Ngexta tana ũ?

Nguepataŭwa.

¿Taxcŭ tanaxwexe?

Poxine.

Nachaxu i ngĕma poxirewa cucax i noxreŭwa, rŭ inamuxŭchixŭwa.



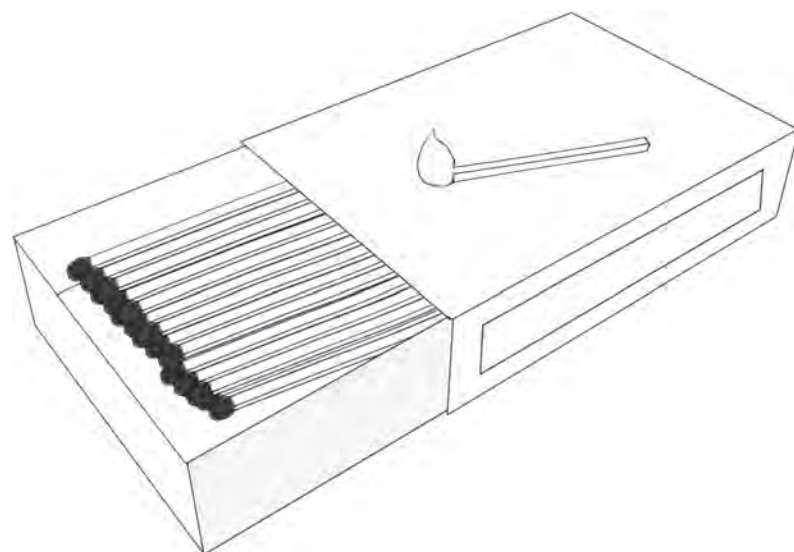

Chauega:

Naãne tigu

Nguexêteruũ nagu i ù

Buxũgũ rü naĩnücawexegũ nagu i naãne.

Papa nũxũ cuaxemaxã tagu i naãne.

Nguexêteruũmaxã wũxigu naãnewa taxĩ itangegũ i paritu rü dexa.

Papa nũxũ cuaxe rü tafeũẽira nangẽmaãcũ meã a aũcax i naãne.

Nũxũ narü daunü nañuxãcũ a guxũ i naãne.

Nawoegu nguepataũwa rü nachiga nidexagũ i ngẽma puracũ naũgũ.

Nguexêteruũ rü cagũ ta ü.

- ¿Ñuxãcũ nagu tanangixi i naãne?

- ¿Ngẽguma napuxgu name nanaãnegu nangixi?
- ¿Taxcũ nangupetü ngẽguma tama meã a axgu i naãne?

¿Texe tũxũ tarũngũxẽ?

Buxũgũ, papa rü mama.

¿Ngexta tana ü?

Naãnewa.

¿Taxcũ tanaxwexe?

Paritu rü üxü.

Nachaxu i ngẽma papa namaxã i guane.



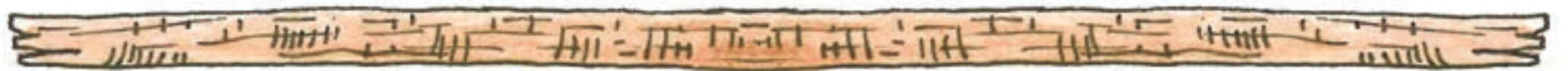

Chauega:

Ãxtapechawa yigüna tadaugü i toegügu

Nguexëteruũ nagu i ü

Nguepataũxätüwa taĩnücawexegü.

Buxügu maxã nuxü tixu nawa yigüna
i daxu natama äxtape tüxü ngoxü
ngëguma i toegu.

Ãxtapearü mucawamaxã nügü
nifaxigüpara rü guxüma i naxünegüwa.

Buxügu rü nanagü ya naxme taxüne rü
ñuxmachi naparagü.

Nachiga nidexagü i äxtape i tanüta,
íranüta, nuxnüta rü maxnüta.

Nugü ünewananagü i buxü taxüne i
amenax machane nuxhane.

Buxügu rü naixnüta maxã nana gugü
noxrü max, naĩmaxã nanangü noxrü
tanuta powapaweru maxa nanangu
noxrü ĩ tamexna nanagü noxrü tanuta
powapaweru maxa nanangu noxrü ĩ
ramexna bixichiũ paweru maxã nanagü ĩ
nuxü.

¿Texe tüxü tarüngüxë?

Buxügu.

¿Ngexta tana ü?

Nguepataũwa.

¿Taxcü tanaxwexe?

Naixnüta rü bixichiũpaweru.

Wüxigu nanu tomaëpüx i äxtapexrexü: ixranüta rü tanüta.





Chauega:

¿Ñuxãcũ narũ ü i chawũ?

Nguexêteruũ nagu i ü

Nũxũ tanawex a chawũ metanũne rü inaxĩgũpũxũne.

Taanaxĩũgũpũxũ ya chawũ metanũne rü tomaẽpũx nguneũ namaxã tanguxũ.

Tomaẽpũx nguneũwena nũxũ tadau tũmamaxã a nguexêteruũ.

Nũxũ narũ daunũ ya chawũ rü ügũne rü nachiga nidexagũ.

Nguexêteruũ rü cagũ ta ü.

- ¿Taxcũũ pedau tomaẽpũx nguneũgu?
- ¿Ñuxãcũ nanatoraũ?
- ¿Nañuxraũ i naãtũgũ?

- ¿Texe nũxna tadaugũ?

Naãnewa nanaboxgũe ya chawũ.

Naũxchicũnaxã i naxchumaxã.

¿Texe tũxũ tarũngũxẽ?

Buxũgũ.

¿Ngexta tana ü?

Nguepataũwa rü naãnewa.

¿Taxcũ tanaxwexe?

Chawũ paxĩatu.

Naũxchicũnaxã ya chawũ rü boxgũne.



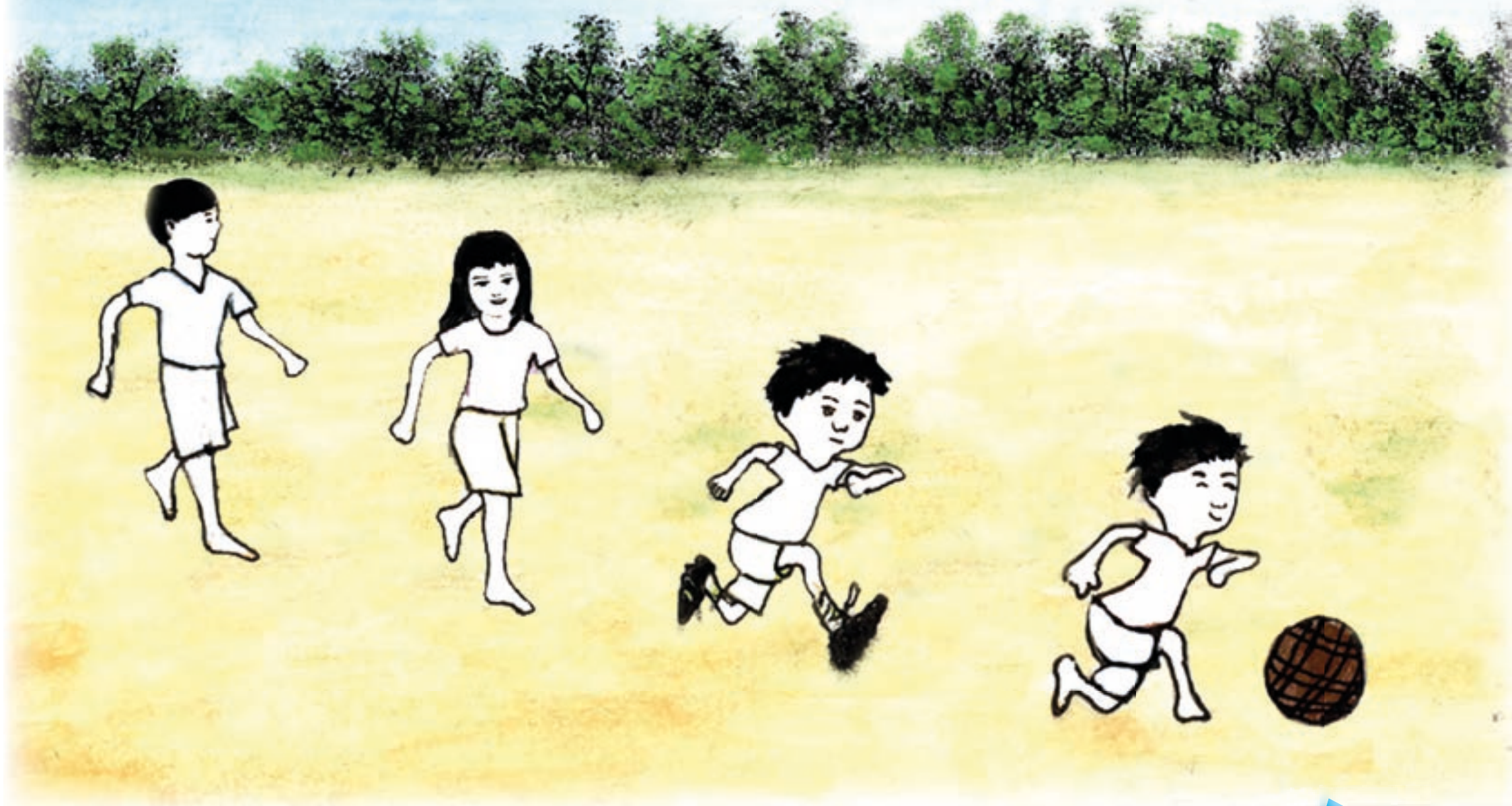

Chauega:

Poitaarü inücawee

Nguexëteruü nagu i ü

Buxügu rü nügümaxā nañücawexegü,
wüxi niyima nanügüchacuraü.

Wüxi tananu ya poxíre wuxí matanüna
wuxi ngëere, maxtanüna, ngeëre,
matanüna, ngëere.

Nüxü narü daunü rü ñuxmachi nachiga
nii dexagü i ngëma naügü namaxā ya
poxire.

Ngueëtaerüü rü cata ü.

- ¿Taxacgügu i inücawaxegü?
- ¿Texegü naügüe i puracü?
- ¿Ñuxre ya poxire nua inagücü?

Nanayaugü i poperaatü puracurüü.

¿Texe tuxü tarüngüxë?

Buxügu ngueëtaeru ü.

¿Ngexta tanaxü?

Nguepataüwa.

¿Taxcü tanaxwexe?

Poxíre.

Tüxü nachaxu i buxe i napexegu i üxë rü tuxü inawüegu i tümaarü ngux.





Chauega:

Taadexechi i ngēmaxūgū i nanū namaxā i to

Nguexēteruū nagu i ū

Itachoxū rū nachiga tidexagū i ngemaxūgū namaxā i paixū.

Papa, buxūgū rū nguexēteruū tadexechi i ngēmaūgū i namaxā i paixū.

Tadexechi i ngēmaūxgū i namaxā i paixū.

Nguexēteruū rū buxūgūna cagū ta ū.

- ¿Nuxre i ngēmaxū tidexechigū?
- ¿Texegūarū ngūxēma tadexechi i ngemaxūgū?

Nūxna tanana i poperaatū puractūruū.

Ngēxta namaxā tanguxū i ngemaxūgū.

¿Texe tūxū tarūngūxē?

Buxūgū, papa rū nguexēteruū.

¿Ngexta tana ū?

Nguepataūwa.

¿Taxcū tanaxwexe?

Tara dayeruū.

Nangugū ngūeūrūū ngexmaxū maā ta toé.





Chauega:

Nachiga ti dexagü i nguxüma puracugü

Nuxacü ta puracü:

Ta boxchimüxügü i nguema nangemaxācü yigü inüēñcax.

Nguxüma i puracü i mamachigaarü tauemacügu i ü..

- ¿Nguexētaruxü arü üxēmaxā rü tanangāxü i cagü?
- ¿Taxcü i puracü taxü i tupanachigugu?
- ¿Texe tuxü tarü nagüxēē?
- ¿Ngexta netaxī?
- ¿Toxrü popera i puracürüxüwa?

Nawa tapuracüe i ngēma naatü puracütüxüwa nüxü a ú.

Guxma puracü i tupanachigu i ü nüxma nacuaxāchi nataxcü cuxü, tapuracüe ngē chañācü, tanaüxchicünaxā, achaxugü ngema chanaxwexeüchi.







Ngěma tuxewa i ügüxü



Toxreraũnewa ya tũxewa cũxũta
ũ pa uipai dexenewa rũ choxũne
wa cuxũta ũ pa ũi namachimaã rũ
choxnima ã cuxũ ta ngõx pa ui pa ui.

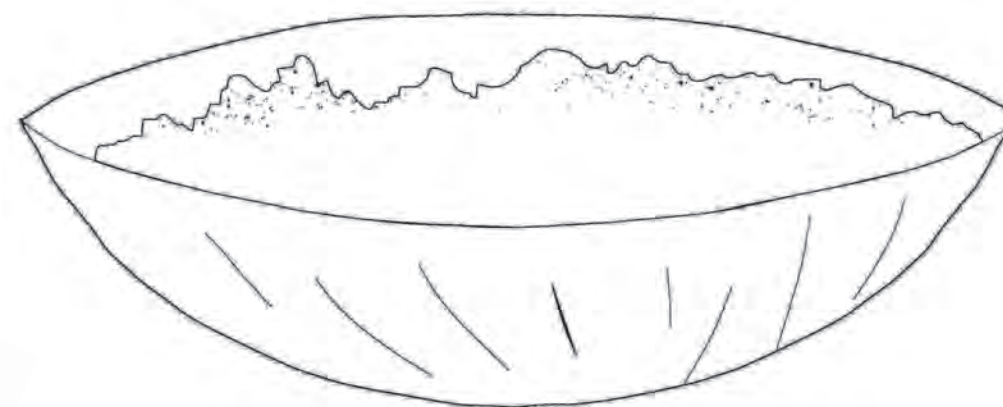
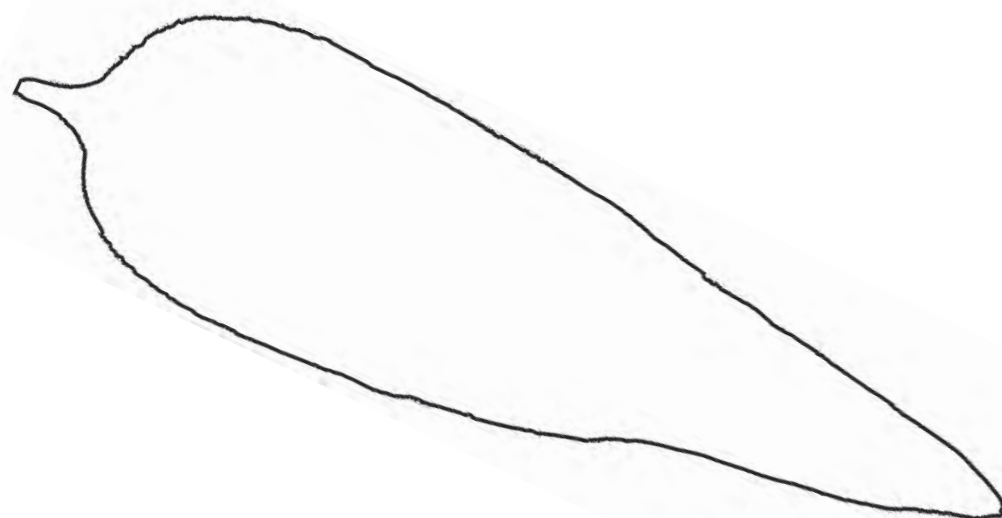

Chauega:

Nüxü tacuax i tuxearü wiyae

Nguexêteruü nagu i ü

Nguexêteruü tanawex ya tüxe i dexene rü choxüne.

- ¿Taxcü naüxe a buxügü?

Tanawex i wiyae naxchicünamaxā ya tüxe, yigümaxā nüxü tixugü. Itaanguxê nawüxiechigü i tümawa naguxe natidexaüca.

Taxrechimaxügu yigü tanu naxi wiyægüxüca guexêmaxā, ngemawena i āxchimaxüācü.

Nguexêteruümaxā tawiyægü.

Tana ngaxü i ñuxre cagü.

- ¿Ñuxreraüne tüxe tuxü nangëxma?
- ¿Taxcüwa tuxü namexü?

Nguexêteruü tanawex i naxchicünaxā rü nüxü niuxchigagü.

Nawiyægü wüxigu i büxügü.

¿Texe tuxü tarüngüxê?

Nguexêteruü rü buxügü.

¿Ngexta tana ü?

Nguepataüwa

¿Taxcü tanaxwexe?

Naxchicünaxā, wüacüruü, poperaatü, tüxe.

Tawiyægü, tanachaxu i tüxechicünaxā.



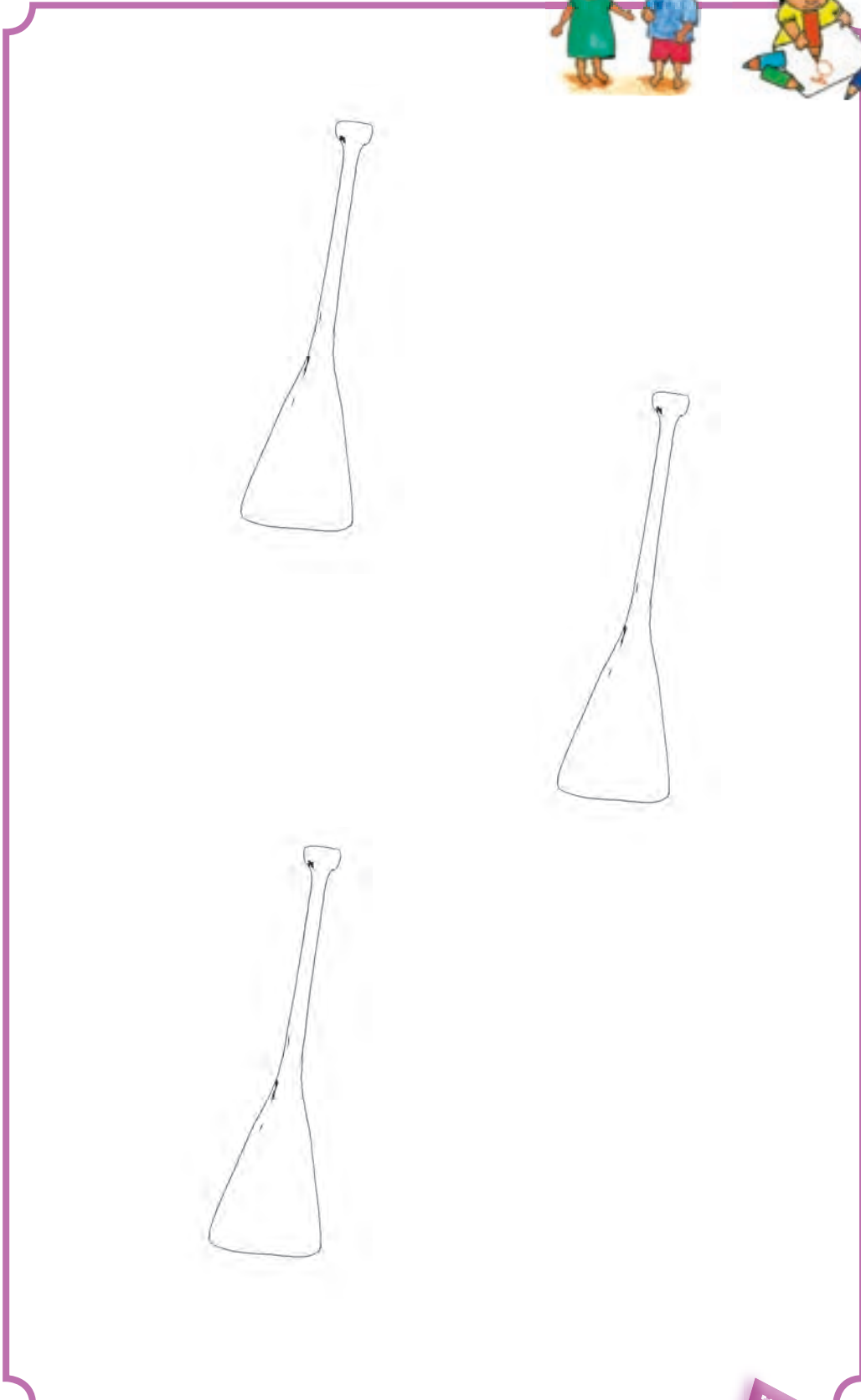
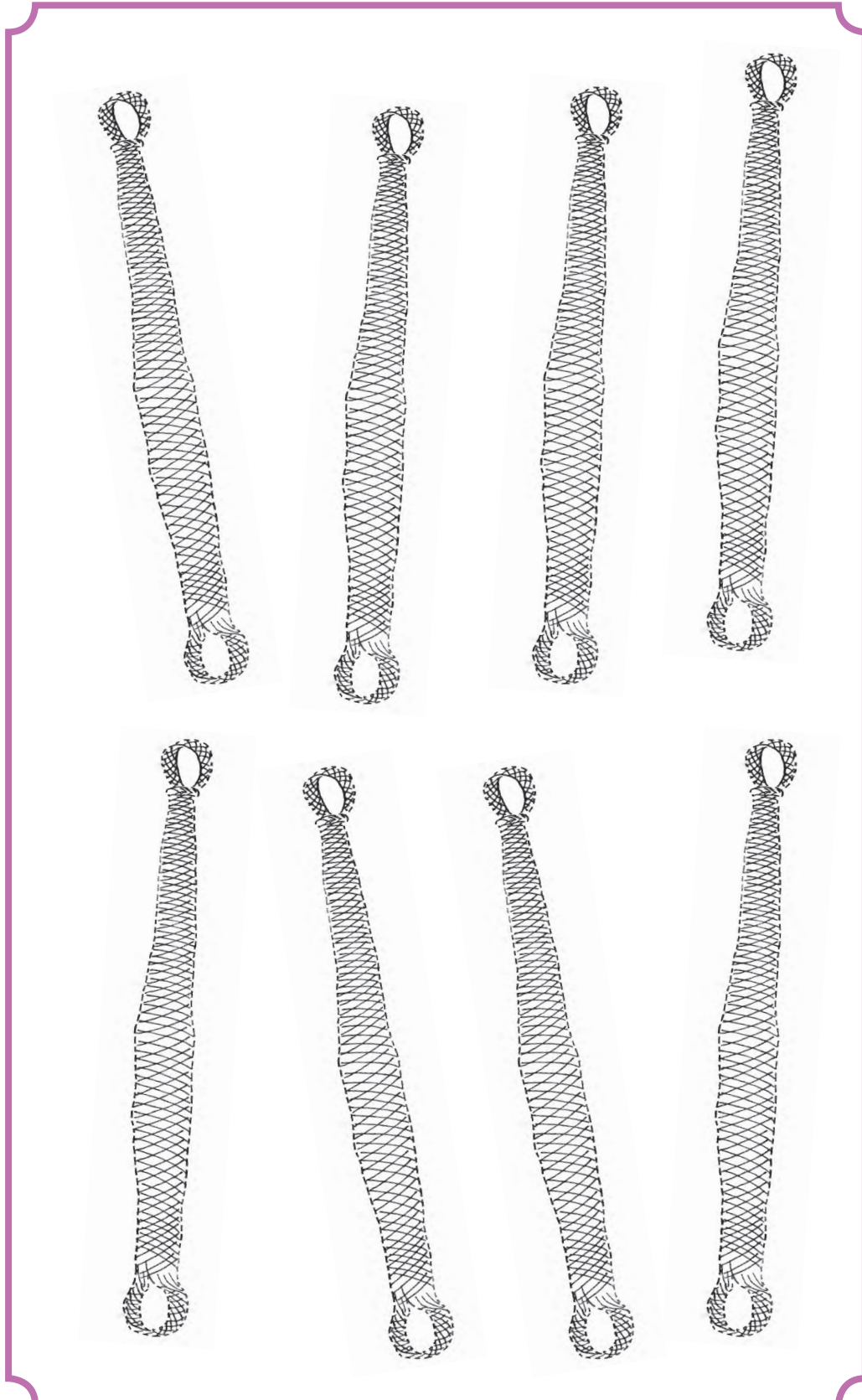
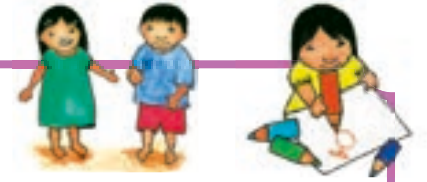

Chauega:

Taadexechi i ngemaũgũ i uieruũ

Nguexēteruũ nagu i ũ

Nguexēteruxũ rũ buxũgũmaxā nachiga nidexagũ i ngēmaũgũ i namaxā i puracũxũ ega i uixgũgu.

Yigũ taũxchimaxũ taxregu.

Toxchimũxũgũ rũ tũxũ nichauxgũ.

Nguexēteruũarũ ngũxēmaxā taxũegagũ rũ tadexechi i noxrexũ. Tanangaxũ i ñuxre cagũ

- ¿Ngēxgumachi nataxugu i ngemaxũ i namaxā naxũ i u?

Buxũgũ rũ nũxũ narũdaunũ.

Nachauxgũ i naxchinaxā i ngēmaũgũ.

Inanayoxochi, nachiga nidexagũ nangexta namumaxē rũ nanoxre.

¿Texe tũxũ tarũngũxē?

Nguexēteruũ rũ buxũgũ.

¿Ngexta tana ũ?

Nguepataũwa.

¿Taxcũ tanaxwexe?

Naxchicũnaxā.

Bũxũgũ mexā nũxũ narũ daunũ i naxchicũnaxā, nachauxgũ ngexta inamumaxēũwa, inanawũegu ngexta i nanoxreũwa.



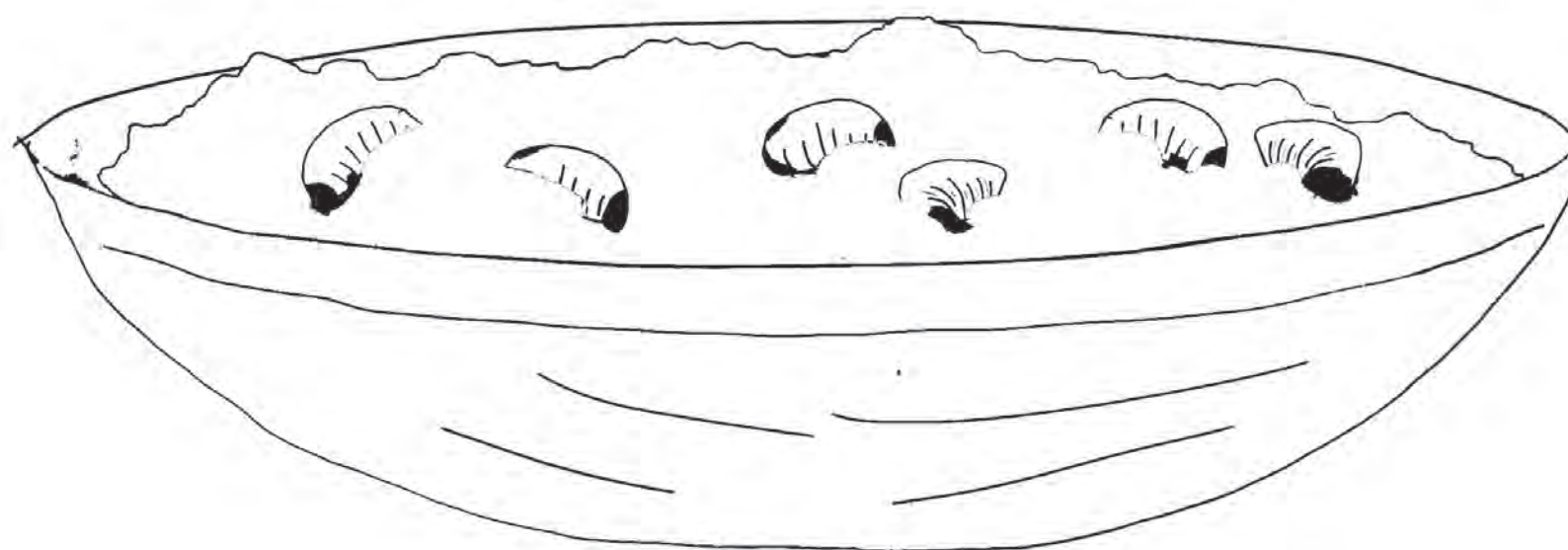

Chauega:

¿Ngexta nangoxe i boxo?

Nguexēteruũ nagu i ũ

¿Taxcü naüğü i buxũgü? Nanangaũgü i cagü.

¿Nüxũ pecuaxũ nataxcüyixĩ i ngaũxchipax ?

¿Ngexta nangēma?

Wüxie duxaē tũxna tadaxú i tũxũ nangēxmaē i uimũchara i yixiũ.

Tũmaũtawa tangugü rü tũxũ tarü moxēgü ya duũxē ya tũxũ nangexmaē i uimũchara.

Nüxũ itatomaxēgu i uimũchara rü naxca tadau nangexta nangoexũ a boxo.

Ñuxre cagü ta ü.

- ¿Taxcü nanangoxeē i ngaũxchipa?
- ¿Texe mexē tanamugü?

Tananutaquexe i ngaũxchipa tadexechi i taxũ rü ixraũ. Tana piritanü i taxũ noxrũwama rü ixraũ

noxrũwama rü tanangõxcu.

Nüxũ taarü dounü i ngaũxchipa i ngexēũ ñuxmachi tanangõxcu wüxigu.

¿Texe tũxũ tarüngüxē?

Oxi, noxē, tutü rü buxũgü.

¿Ngexta tanaxü?

Noxēũtawa, nguepataũwa.

¿Taxcü tanaxwexe?

Panera, piritaechiũ, ngaũxchipa.

Poperaatü puracüruxũ.

Nachaxu i naxchicünaxã i uimũchara ngauxchipaxã.



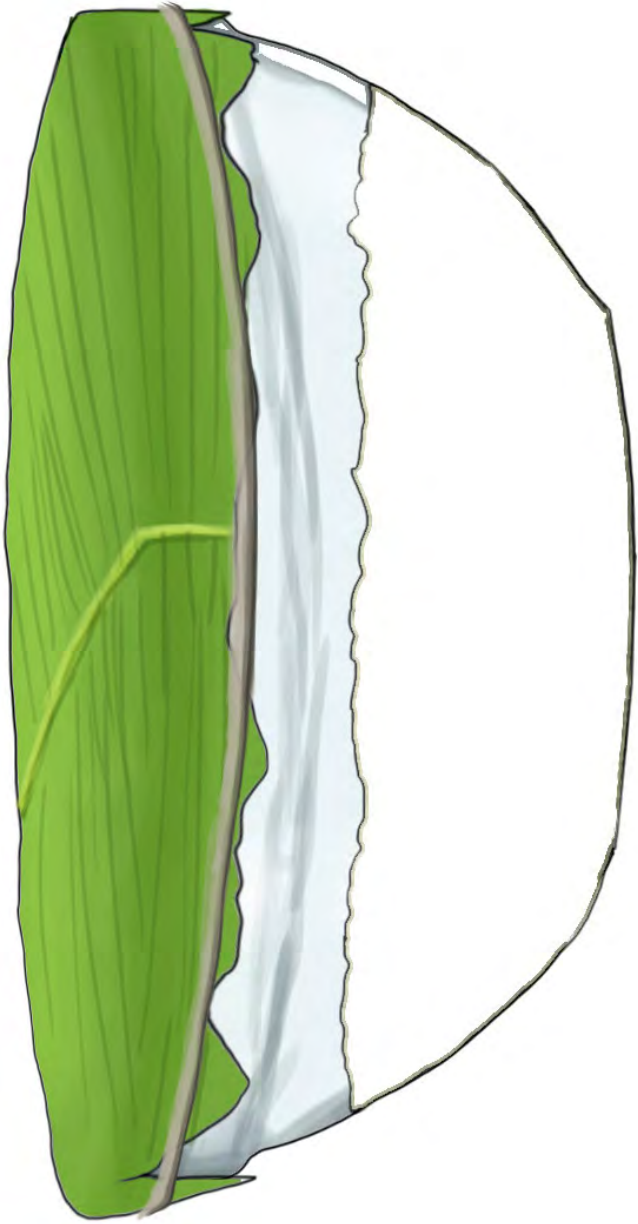
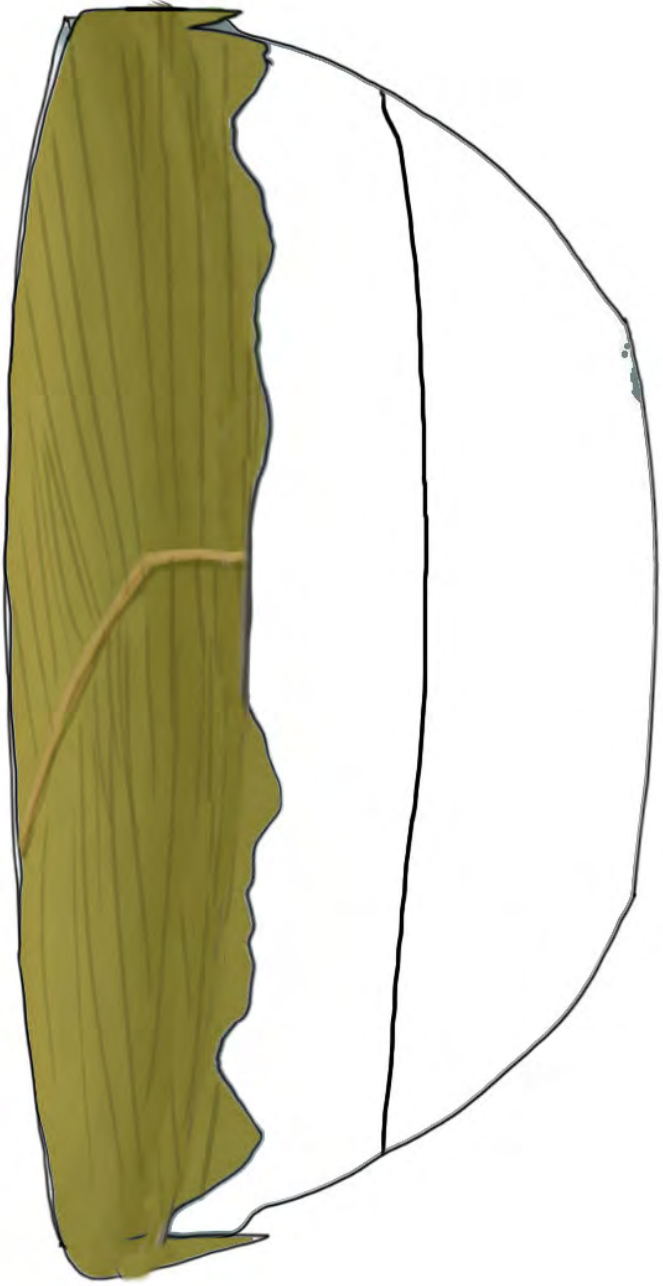

Tadexechi i ngäuxchipax i umüarü

Nguexëteruü nagu i ü

Tümaütawa taxī ya noxē tūxū
nangexmaxē i uimüchara i marü
ñuxgumamaxū.

Tüxna tataca ixraü. Ñuxmachi ixrarüwa
tūxū tarü ngüxē i ñuxēmüwa.

Tawoegu nguepataüwa taxī. Tana ü i
puracü ñaxū:

Taxre i ngëmoügu tana nucuchara,
ngaxwe taamachi wüxi rü tama
ta naxīextü ngëma ta rü mexā
tanaxiextü poxiatümaxā, ñuxre i nguneü
tangupetüxē.

Ngemawena nüxū tarü daunü
ngëxürüxū yixī i ngäuxchipax.

Nachiga tidexagü yigümaxā, buxügü rü
nguexëteruümaxā.

Buxügü taxrechigügu nügü nanu
natüxū nauxchicunaxāüca i ngaxwe, rü
ngäuxchipax.

¿Texe tūxū tarüngüxë?

Nguexëtaeruü.

¿Ngexta tana ü?

Nguepataüwa.

¿Taxcü tanaxwexe?

Poperaatü puracüruxū ngaxwe, poxiatü
rü naxīnüta.

**Buxügü naa üxchicünaxägü i taxre ngëmaxügü i uimüchara nagu naügü. Tūxū
nauxchinaxā i boxo. Wüxiwa muxë rü towa nata noxre.**



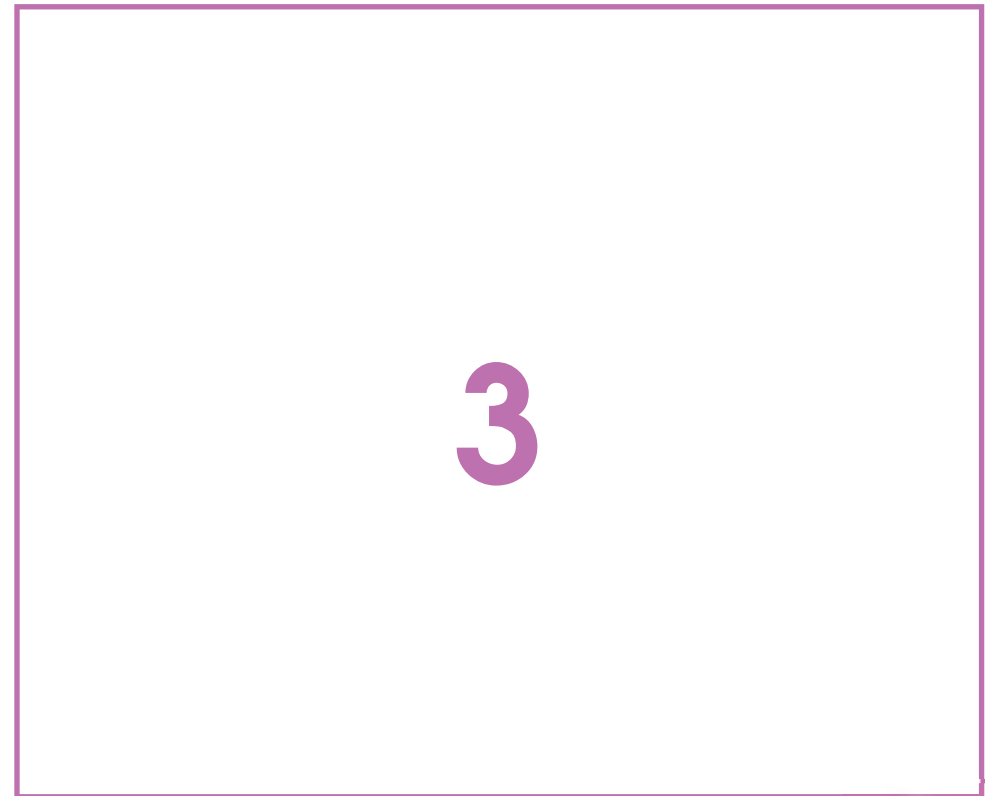
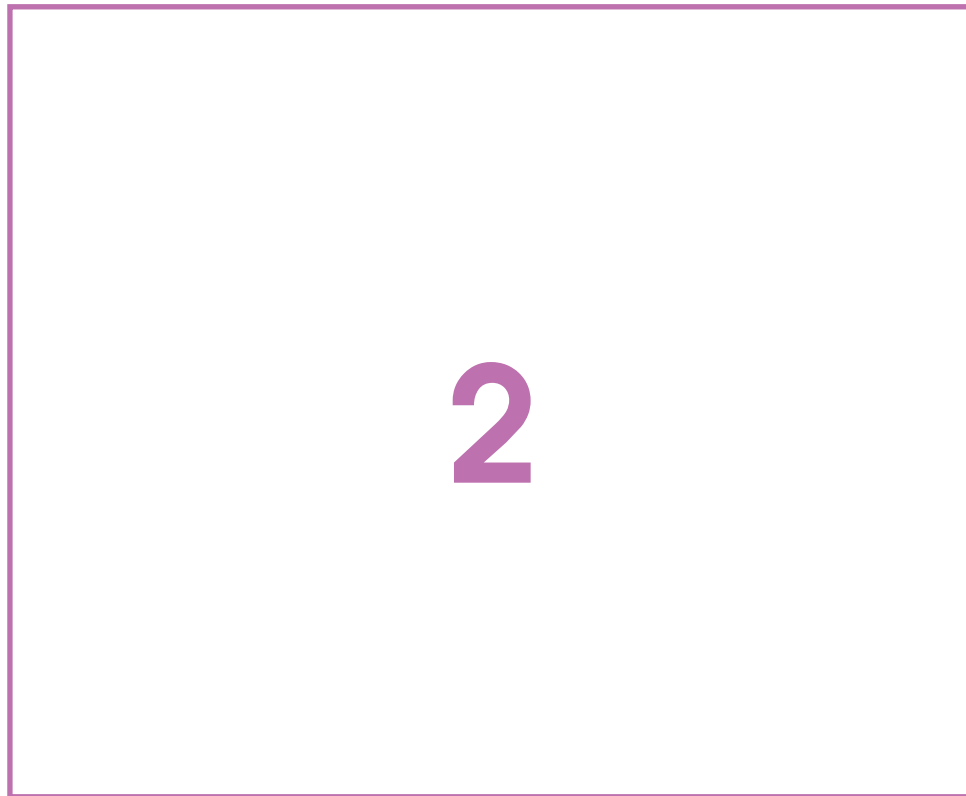
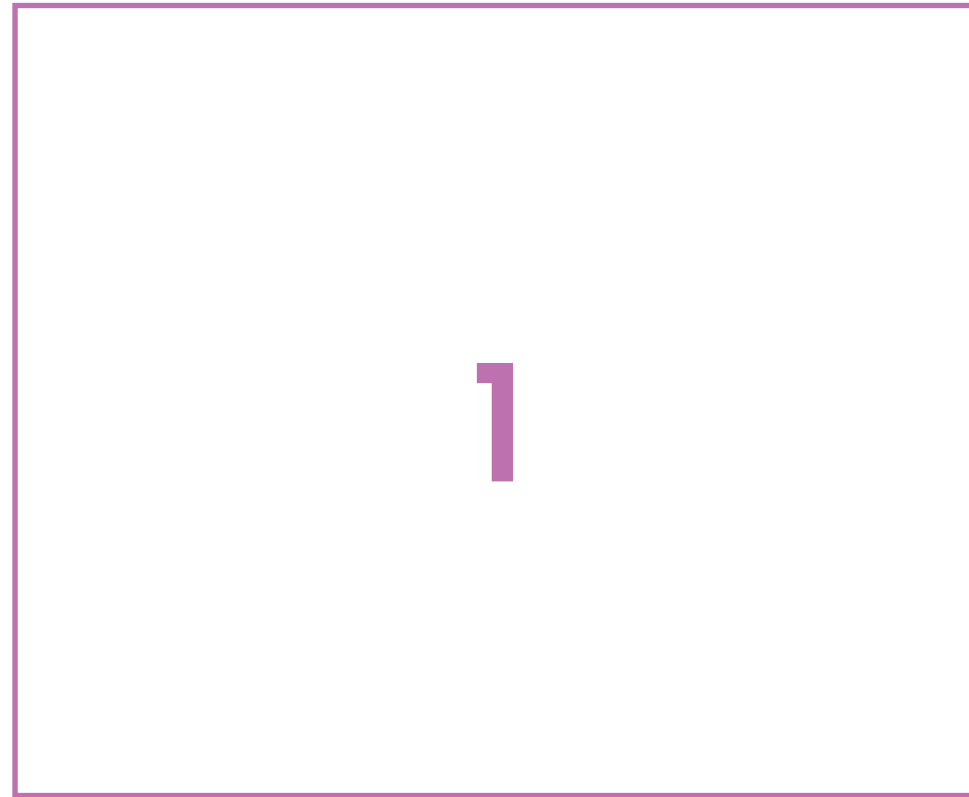

Chauega:

Tüxü tarü daunü ya noxe i goxee

Nguexëteruü nagu i ü

Yügü tanu āxchimaüxācū, ñuxmachi tanayaxu i wüxi naxchicünaxā, ngexta tanguxe i mexü nacüma.

Tümaxütawa taxī ya noxē vita i ngoxee, tüxü tarü moxëgü, ixrarüwa tüxü tarü ngüxë.

Tanangaxü i ñuxre cagü

- ¿Ngexta yixī nenaüxü i ui?

Buxügü nanangaxü: Wüxichigü noxë natawoegu nguepataüwa naxī.

Nguexëteruü, rü buxügü nügümaxā nüxü nixugü i noxrü ñnügü nachiga nawa nenaxī.

Buxügü nachiga nidexagü nügümaxā nanañuxreraü i ngoxechiga.

¿Texe tüxü tarüngüxë?

Noxë, buxügü, nguexëteruü.

¿Ngexta tana ü?

Nguepataüwa, ñaxtüwa.

¿Taxcü tanaxwexe?

Poperaatü puracüruxü, rü ngaxwe.

**Buxügü inanāxcuchi i naxchicünaxā, noxrü ügü, noxrü ngāxü rü noxrü ngúx.
Wüxichigü inawüxegu.**





Chauega:

Noxëũ tarũ ĩnũẽ ñuxãcũ naca i caxũ nanataũcax ya tũpaca

Nguexëteruũ nagu i ũ

Noxë nũxũ cuaxeũtawa taxĩ, tũxũ tarũ moxëgũ, tũxna tacax rũ tamaxã nũxũ tixu nañuxãcũ tũxũ nataxũca ya tũpaca.

Itarũ togũ boxchimaxũãcũ mexã tarũ ĩnũxẽ tũmaxã tidexagũ, nañuxãcũ naxca i caxũ: Wũxi nixĩ nanexgũchixĩ ya tũpaca (ne ne ne ñagũxũ).

Ngemawena rũ noxëna tawoegu, nguepataũwa taxĩ.

Nachiga tidexagũ nanoxëũtawa netaxĩ.

Tanangaũ i cagũ.

- ¿Ñuxguãcũ nixĩ naxca i caxũ?
- ¿Ñuxãcũ naca itaca?

Nũxna tacuaxãchi nañuxãcũ naxca i caxũ natũxũ nataxũca ya tũpaca.

Bũxũgũ nachiga nidexagũ, tama mexũ ega i tũpacaxegu.

Wũxi nixi natama nangaxtaũ cuexchimaxã.

¿Taxcũwa tũxũ namexũ ya tũpaca?

¿Texe tana bũxgũ i pexchi?

¿Texe tũxũ tarũ ngũxẽ?

Buxũgũ, noxë.

¿Ngexta tana ũ?

Nguepataũwa, ĩaxtũwa.

¿Taxcũ tanaxwexe?

Tũpaca, poperaatũ puracũruxũ.

Inanayoxũ i naxchicũnaxã ngexta noxë namaxã nũxũ i uxũwa.





Chauega:.....

Dowüarü üxchiga

Nguexëteruü nagu i ü

Buxügü rü tüpaca neningegü dowüruxü.
Wüxie mamana taxú natamaxā dowü netaguxücax.

Togü tanuxchimaxü tomaëpüxgu.

1. Wüxichimaxü i buxügü rü napaxëgü.
2. Toxchimaxü nanayoxügü.
3. Noxrü tomaëpüxchimaxü rü üxüwa naxī.

Buxügü narü daunü nañuxācü itanaguxü ya dowü a mama.

Marü naguxgu inanguxü ya dowü rü tanangoxcu wüxigu.

Nachiga tidexagü nataxcü i toama nawa i üxü ya tüpaca.

Tana ü wüxi ngëmaxü, titeres, ñuxmachi taxadexaë nañuxācü naüxü i dowü.

Taxcüwa tüxü name ya tüxe.

Taxcü i tomaxā i üxü ya tüxe.

¿Texe tüxü tarüngüxë?

Buxügü rü mama.

¿Ngexta tana ü?

Nguepataüwa, ïäxtüwa.

¿Taxcü tanaxwexe?

Piriteruü, bidaüataxü, cuyera cüxchi naxchiru rü tanimaca.

Buxügü nananucu i ngema meā nagu rü ünüeācü wüxigu i nu, dowüarü rü exna tüxearü.



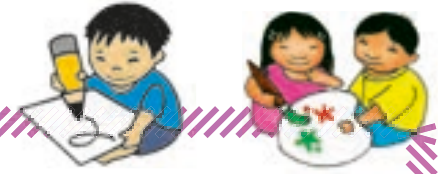

Chauega:.....

Naĩnũcawexegũ namaxã muturureũchicũ naxa.

Nguexẽteruũ nagu i ù

Buxũgũ nũgũ naũxchimaxũ naxũpa
nanaĩnũcawexegũ nguепатаũxãtũwa.

Naĩxãtũ tanabuxgũ, narañaatũ,
cupuatũ, mangoatũ rũ toamachigũ.

Boxchimaxũãcũ itarũ togũ, tanagauteatũ
i naxĩãtũ ngãxũgu, ngexgumarũxũ,
ñuxmata namuturureũraxũ.

Ngẽmawena rũ ngaxũwa tapaixpetũ i
tuxu narañaarũ.

Buxũgũ nũgũ naũgũ namaxã natexeaũ
poraãcũ tabixũ. Texe poraãcũ tañaxãchi,
paxa itangũ namaxã i birũxũ ngexta i
ngugũchaxũwa.

Buxũgũ nũxũ nixugũ natexe poraacũ
ñaãchi.

Texe tipa.

Nũxũ tacuax nañuxãcũ ya iãxcũxũ i
maxũne rũ nagu tingõgũ.

¿Texe tũxũ tarũngũxẽ?

Buxũgũ, yatũxũ rũ ngexũgũ.

¿Ngexta tana ù?

Ĩãxtũwa.

¿Taxcũ tanaxwexe?

Nanaũxchicũnaxã i buxũ i poraxãcũ i
ñaãxũ.

Inanãxcu i naxchicũnaã nataxcũ i towa namexũ ya tũpaca.



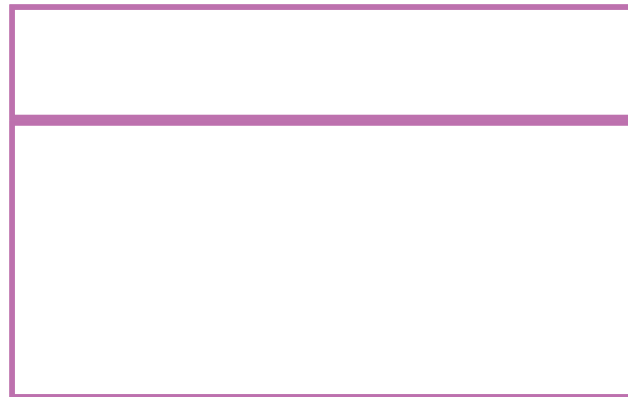

Chauega:

Tana ü empanada rü üchara tuxewa

Nguexëteruü nagu i ü

Buxügu wüxigu nananu ya tuxe choxüne.

Tüxna taxú ya mama naempanada tataüxü rü üchara.

Ngexgumarüxü i ngëmaxü i nawexü i empanada rü ücharaarü üruü, tanawexe nanangematagüxü.

Nüxü itatomaxëgu ya tuxe rü tanangaüxtanü. wüxigu tanayauxtanü, tanamuxratanü, bachiagu tanagü rü tacamütanü rü tanaüxeü mexāma. Itanaüxü i empanada, bopütaxācü rü exna wixācü.

Togü i buxügu nayoxni üchara tainaügu, tuxearü waxinewa. Ngexguma narü naguxgu nanaüxü i empanada rü üchara, taaugü nañuxre i nguxuchi. wüxichigü yigüna taāgü.

Wüxigu tananu i empanada rü üchara.

¿Texe tuxü tarüngüxë?

Mamagü.

¿Ngexta tana ü?

Nguepataüwa, iāxtüwa.

¿Taxcü tanaxwexe?

Tuxe, naixmenaxā, cüxchi, panera poperaatü puracüruxü.

Tomaëpüx i buxügu rü tomaëpüx üchara naügu.



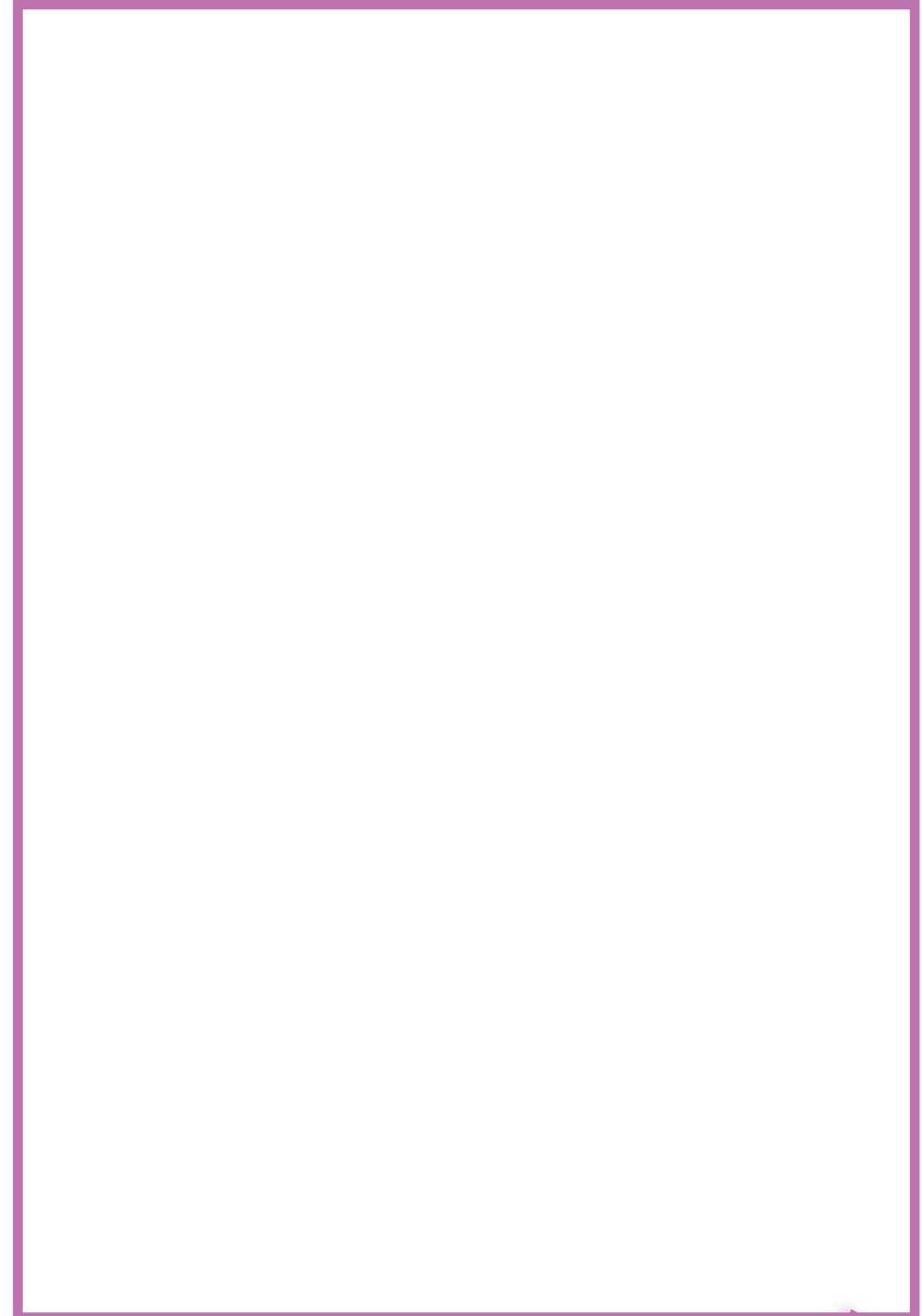

Chauega:

Tüpaca tingoxü

Nguexëteruü nagu i ü

Taxrechimaxügu yigu titoye, nüxna tacuaxāchi i naxchicünaxā i mexü i nacüma.

Tümaxütawa taxī ya noxē i tüpaca i goxchaxüe.

Tüxü tarü moxëgü.

- ¿Taxcü naüxe i buxügü?

Ixrarüwa tüxü narü ngüxëgü.

- ¿Taxcü tanawexë ngëxguma tüpaca i ngoxügu?

Buxügü nanangaxü i cagü namaxā i nüma nüxü nacuaxgü.

Ñuxmachi tüxü tarü ngüxë yoxüëwa, rü noxrü paëxwa.

Ngëmawena tüxna tawoegu.

Nguepataüwa taxī rü nüxma tacuaxāchi nataxcü noxeütawa i ügüxü.

¿Texe tüxü tarüngüxë?

Noxë, mama, nguexëteruü.

¿Ngexta tana ü?

Nguepataüwa, iäxtüwa.

¿Taxcü tanaxwexe?

Tüpaca, tanimaca, cuexchinü tauxechigu, goxeperu.

Inanāxcu i naxchicünaā nataxcü i towa namexü ya tüpaca.





Chauega:.....

Nachiga tidexagü guxüma i puracügü

Nuxacü ta puracü:

Taboxchimaxügü i guema nangemaxācü yigü i inüēñcax.

Guxüma i puracü i i juanchigaarü tauemacügu i ü.

- ¿Nguexēteruñarü ngüxēmaxā tanangaxü i cagü?
- ¿Taxcü i puracü taxü i tupanachigagu?
- ¿Texe tuxü tarü ngüxē?
- ¿Ngexta netaxī?
- ¿Toxrü popera i puracürüxüwa?

Nawa tapuracüe i ngēma naätü puracürüxüwa nuxü a ú.

Guxüma puracü i tupanachigu i ü nuxma nacuaxāchi nataxcü cuxü, tapuracüe ngēchañcäcü, tanauxchicünaxā, achaxugü ngema chanaxwexeüchi.



Three horizontal dashed lines for writing.





Ticunaguaru
choxniecuma



Oxi i dami nūxū nixu i
choxnínechiga rü ñanagürü:



Choxnine rü wüxi naī taxüchixī
nūxmachi naōxmixā rü ngēma naxchixigü
rü choxnigüxū nanguxū. Ngēxguma marü
nacaixūgu chaxūgü rü pucü, āxēma
cü naxü rü ngexguma narü yi waximügu,
rü nacaxī choxnigüxū, oxü yawarachi,
nixchira, moni tomacachigü, ngēma wena rü
natüxacüpechiwa mu rü nichoxū, nanaxtaawa
naxī naācharaūgü rü marü nügü taxā
nimuxeē, ngēxma nacuax i nachiga.



Chauega:

Choxnine

Nguexēteruũ nagu i ũ

Nũxũ tarũ daunũ i naxchicũnaxã i choxnine.

- ¿Tanangãxũ i cagũ?
- ¿Marũ ñuxgu nũxũ pedaxũ?
- ¿Taxcũ nixĩ i naega?

Tarũ ĩnũē rũ nũxũ tacuax, nangexta nenaxĩ inaguxũraũ i choxnigũ i natũacũwã rũ nataxawa ngẽmaũ.

Buxũgũ rũ wena nũgũmaxã nũxũ nixugũ i ore i ngupetũxũ. Nanangaxũ i cagũ. Nũxũ nixugũ i ngẽma nũma nũxũ nacuaxgũ.

- ¿Taxcũ mexeyixĩ ngẽma nanatũ i choxnigũ?
- ¿Ñuxguacũ nixĩ choxnigũ yixĩ?

Moxũcax tũxna taxu ya nũxũ cuaxe i nachiga i choxnine, nayexeraãcũ tamaxã

nũxũ tiuxũcax.

¿Texégũ tũxũ tarũngũxẽ?

Nguexēteruũ.

¿Ngextã tanaxũ?

Nguepataxũwa.

¿Taxcũ tanaxwexe?

Taatũxũ i popera, naxchicũnaxã rũ popera puracũruxũ.

Inañaxcu nangexta naũgũ rũ ngexta yacuax i naxchicũnaxã rũ wenaarũ nachiga i dexa.



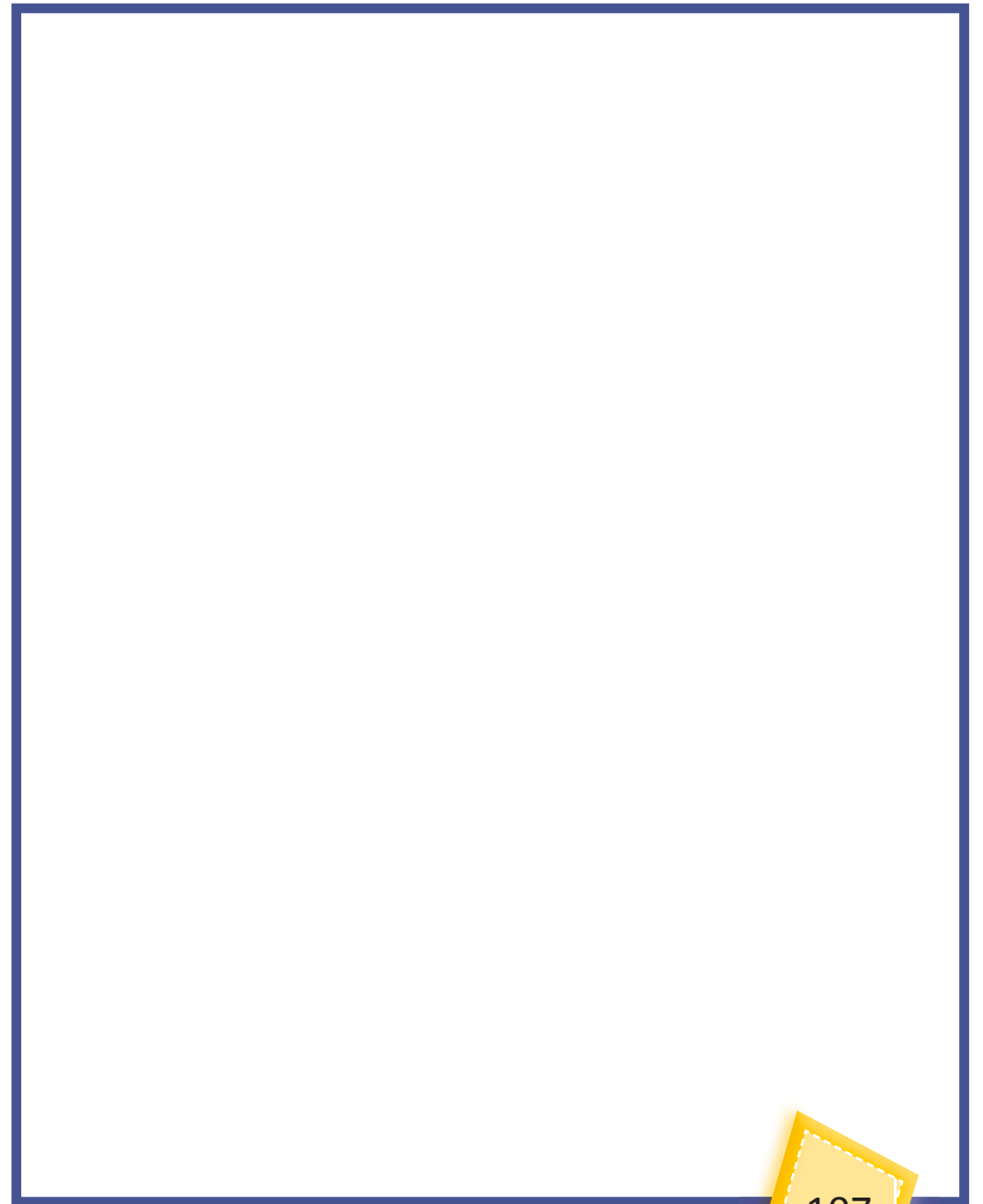
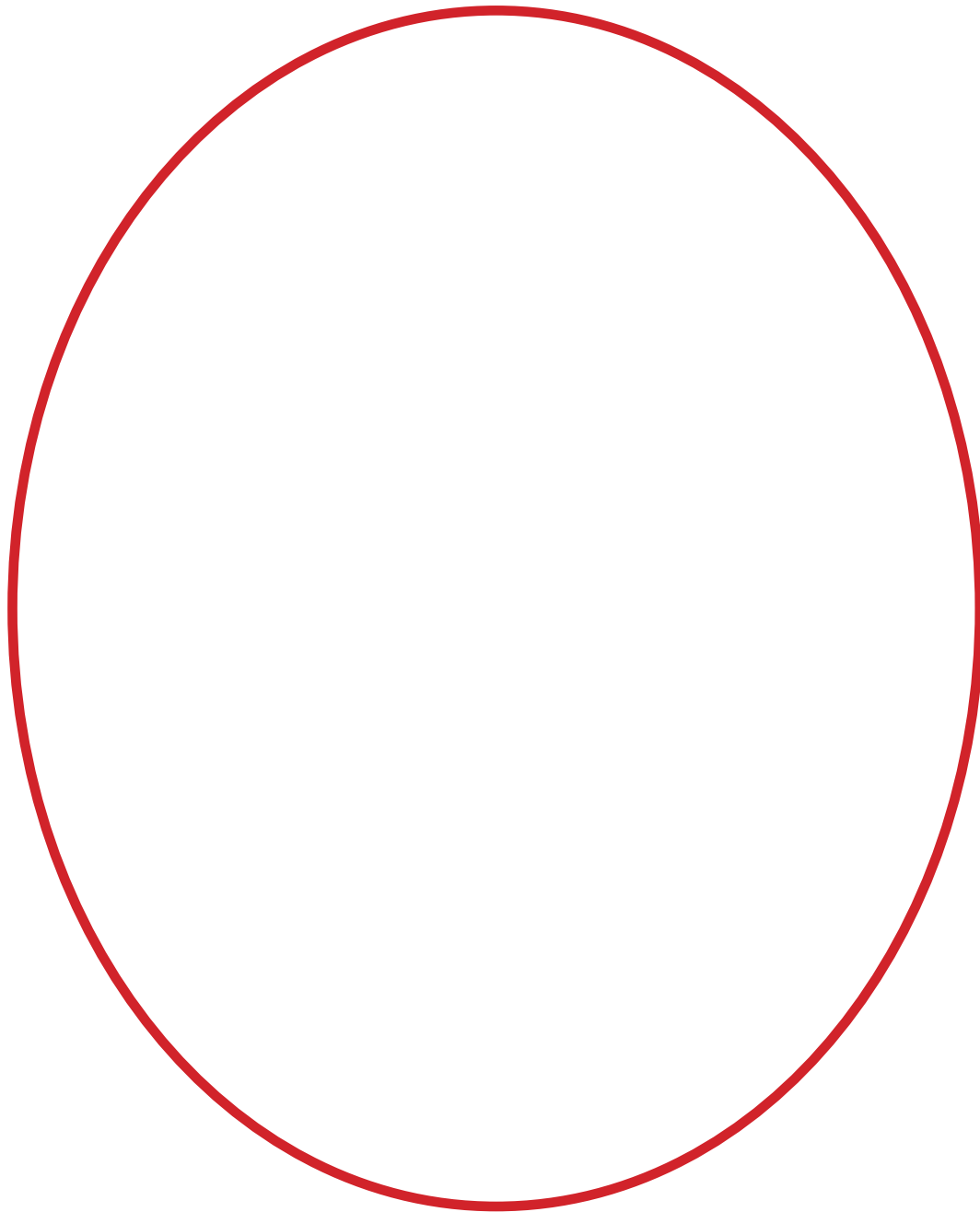

Chauega:

Choxnigü i tama buxüügü ngõxgü

Nguexëteruü nagu i ü

Yigü taüxchimaxüügü taxrechigügu.

Wüxichigü i naxchimüüna tanaxā i wüxi taatüxü i popera i taxregu i wüye.

Wüxicüwawá nanaüxchicünaxāgü i choxni tama i ngõxü rü tocüwawa ngëma choxni i ngõxü.

Oxiütawá taxünatamaxā nüxü tiuxücax nangëxürüxü yixī i choxni i tama i ngõxü.

Inañaxcu i choxni tama i ngoxü rü

ngëma i ngoxü.

Inañaxcu i choxni tama i ngoxü rü ngëma i ngoxü.

¿Texégü tüxü tarüngüxë?

Nguexëteruü.

¿Ngéxta tanaxü?

Nguepataxüwa.

¿Taxcü tanaxwexe?

Taatüxü i popera.

Ngema bopüxügu inadexcu choxnigu i cungõxü rü ngema ägümücücüwaxügu naxü ngema choxnigü tamücü i ngoxü.



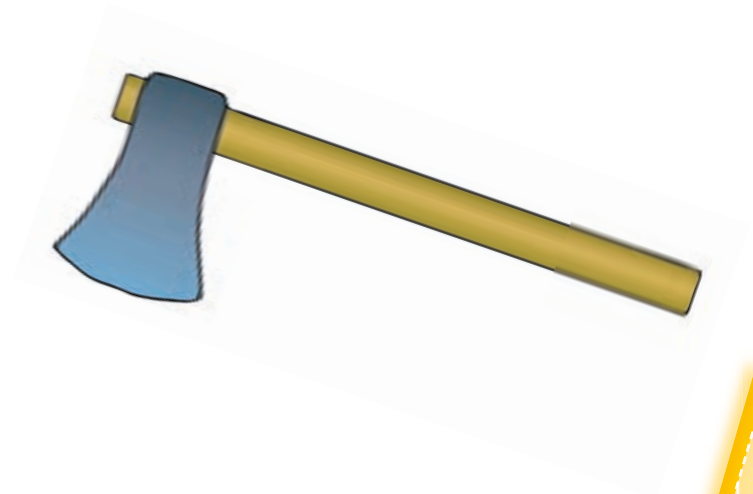
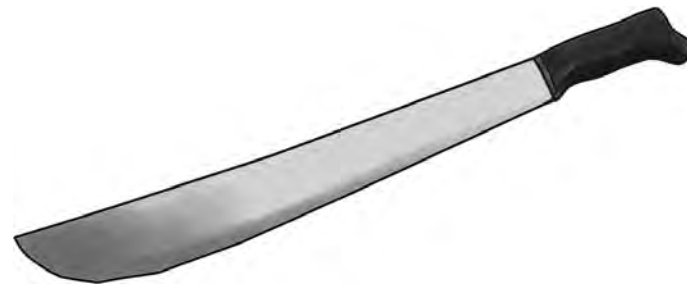
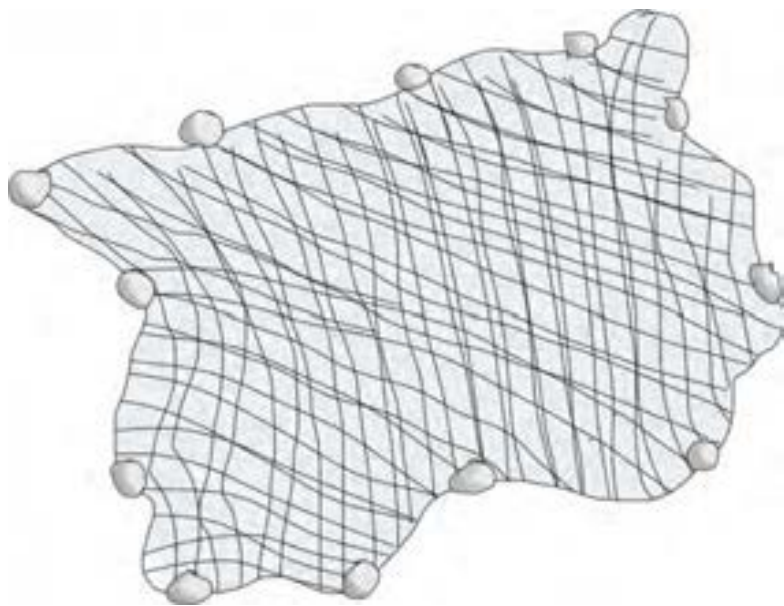

Chauega:

Naxnegü i namaxã i choxniexü

Nguexëteruü nagu i ü

Oxiütawa taxī ya nüxü cuaxe i ngēmaxügü choxniēruxü, natamaxã nüxü

tiuxüca nañuraüchigüxü ya poxwa. Nguēpataxüwá nachiga tidexagü i ngēmaügü i oxi nüxü i uxü, nataxcüwa tuxü namexü rü ngextacüna tananu ya chuxchi, poxwa, arapõü.

Tanangaxü i cagü:

¿Ngëxguma poxwaewa i üxchaxügu taxcümaxã tanaüxügü?

Nachiga tidexagü.

Naxchicüxnaxã nadawenü, rü nacax nadau i ngēmaügü i namaxã i choxnie. Nawüegu i ngēma namaxã curü ü.

¿Texégü tuxü tarüngüxé?

Papa rü oxí

¿Ngexta tanaxü?

Nguēpataxüwá.

¿Taxcü tanaxwexe?

Naxchicünaxã i hoxnieruxü i.

**Naxchicünaxãü nadawenü rü nacax nadau i ngēmaxügü i namaxã i choxnië.
Naümatü nañuxre ngēma.**



Naxtaawá chamaxũ

Ngẽguma charũ
yuxgu rü burü, burü
nãchagürü,rü
choma nixĩ nguxũma i
choxnigüxũ
charũ tamaẽũ.

Texéchixĩ.

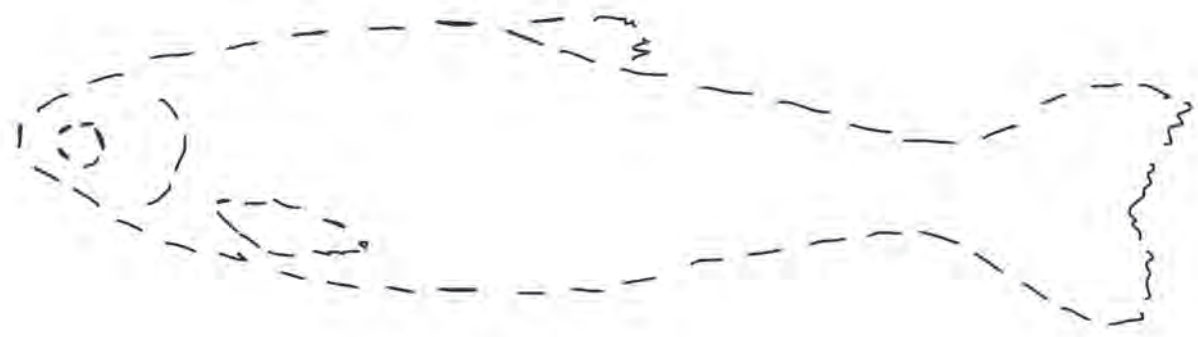
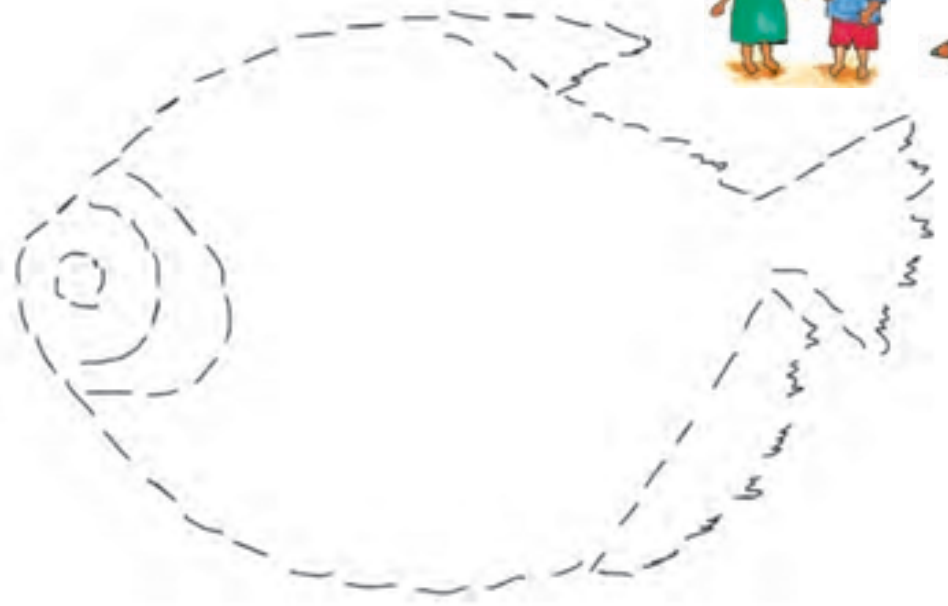

Chauega:

Nagu tũxũ rũ inuxe i choxniarugu i uxu

Nguexēteruũ nagu i ũ

Nguexēteruũxũ tanawex i nagu tũxũ rũ inũxēũ tadaumatũtaegũ wũxigu.

Buxũgũ rũ muxũraũxãcũ nanangãxũgũ.

Nguexēteruũ rũ buxũgũnataca nachiga i choxni nũxũ nacuaxgũ:

Namexũchi nawaá i inũcawaxegũ i nagu tũxũ rũ ĩnũxē.

Nguexēteruũ rũ poperaatũ puracũruxũwá nũxũ tayarũngau i noxrũ naxchicũnaxãgũ.

Nguexēteruũ rũ wena buxũgũmaxã nũxũ tadaumatũ i ngẽma nagu tũxũ rũ

ĩnũxē.

¿Texé tũxũ tarũngũxē?

Nguexēteruũ rũ buxũgũ.

¿Ngexta tanaxũ?

Nguepataxũwa.

¿Taxcũ tanaxwexe?

Nagu tũxũ rũ ĩnũxēũchicũnaxã rũ chauxetaruxũ.

Nachicawa inanãxcu i naxchicũnaxã.



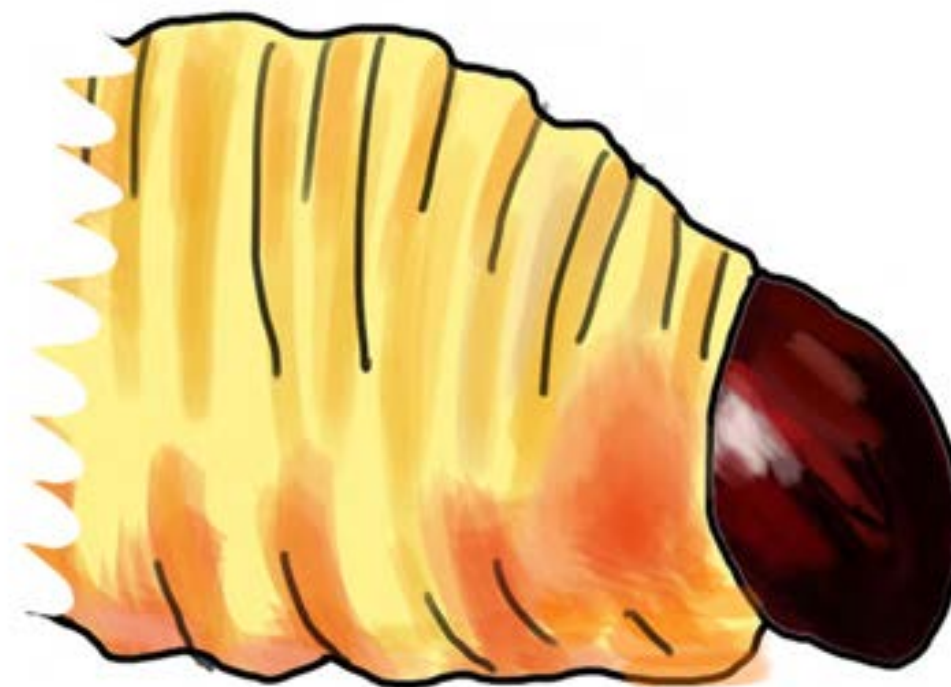

Chauega:

¿Taxcürüü poxiarü boxomaxã tachoxniëgü?

Nguexëterüü nagu i ü

lãxtügu itanayaxü i munü, oxmi, boxo rü burexe. Nachiga tidexagü nañuxãcü namaxã i choxnië. Yigü tayanu i ngëma i yaxü rü mechagu tananu.
-Nügü nayanugü i lupa, daupetüruxü, chaetaruxügü rü taatüxü popera taxregu nügümaxã nayauxyegü.

Nanayauxgü i wüxi boxo,taatüxü i popera, chaetaruxügü.
Naüxchicünaxã i boxo i lupawa nüxü cudauxüãcü.

¿Texé tuxü tarüngüxë?

Nguexëterüü rü buxügü.

¿Ngexta tana ü?

Nguepataxüwa.

¿Taxcü tanaxwexe?

Nagu tuxü rü ñnuxëü, naxchicünaxã, chaetaruxü.

A nguxë i boxochicünaxã.



Three horizontal dashed lines for writing.



Chauega:

Choxniwa tabaxütexegü poximaxã

Nguexêteruũ nagu i ù

Nguepataxüwá choxni tuxũ nangegü, rü
poxi baxütexeruũ.

Mama tamaxã tabaxütexe.

Mamaxũ tarü daunü rü
naëxüwemüxũ tanauxuchietanü.
Iraxũ baxũ nüxrüguama itabaxüchi rü
achucaramaxã tanaüaca tanañuxãca.

Wüxigu tananu rü nüxũ tiügü i naãca
tangexũ rü chixmaxê.

¿Texégu tuxu tarunguxee, mama ru
buxugu?

Nügüwa nadacunüxê i naëxüwemü i baxũ namaxã äëxũ.



Three horizontal dashed lines for writing.

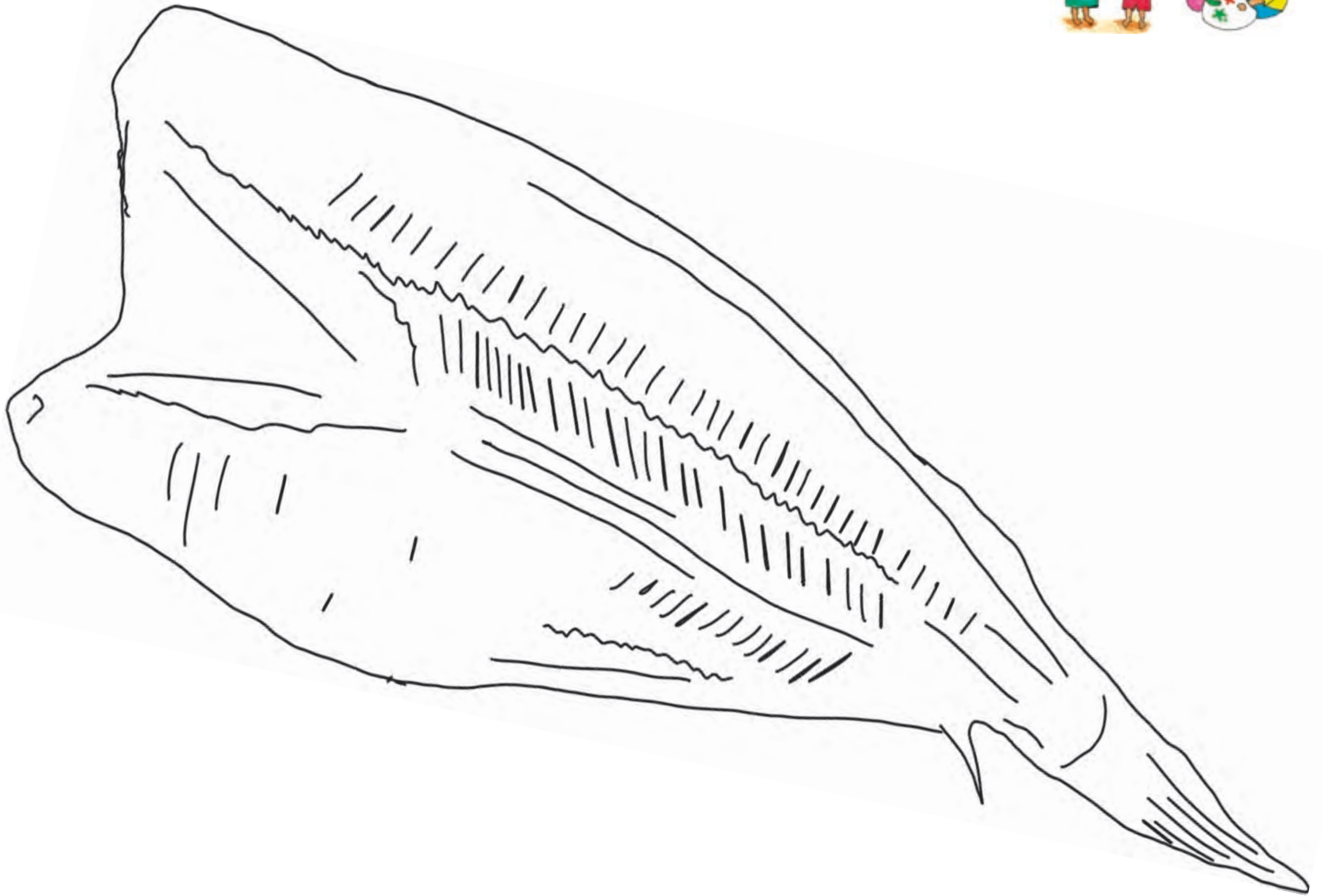

Chauega:

Choxnigümaxã tangüxügü

Nguexëteruü nagu i ü

- ¿Taxcü naxüe i buxügü?
- ¿Taxcü tanaxwexe nachoxnimaxã naingüxü?
- ¿Taxcü nangupetü ega tama nayucüragu?
- ¿Ñuxre i ngunexü tatai?

Buxügü rü nanangaxügü i ngëma nüxü nacuaexü rü nguexëteruü rü tanamexëchigü i ngëma buxügüarü ïnü.

Buxügü rü nuãnanangegü i choxni.

1. Tananá i choxnigü rü ngëmawena wüximaxã tanguxü.
2. Tanawietanü i choxnigü rü ngëmawena wüximaxã tanguxü.
3. Tananuquetanü i choxnigü rü ngëmawena wüximaxã tanguxü.

Nanagugü ngëma namaxã nangüxü wüxi nachicagu.

Yigü titoye nangëmãacü nüxü i cuaexücax nataxcü ngupetü ngëma choxnigü namaxã i nguxü.

- ¿Texegü tanaxügü?
- ¿Ñuxre ngunexü tatai?

Yigü taüxchimaxü nangëmaãcü yigüna i cagüxücax rü tanaüxchicünaxã.

¿Texe tüxü tarüngüxë?

Mama rü buxügü.

¿Ngexta tana ü?

Nguepataüwa.

¿Taxcü tanaxwexe?

Choxnigü, poxiatü, bexreatü, naëüwemü rü yucüra.

Naxchiãanaxã tarüdaunü nañuxãcü choxnimaxã i nguxü. Nachaxu i ngëma aixcüma i üxü.



Chauega:

Choxnigümaxã tanguxũ

Nguexëteruũ nagu i ü

Tana ü nagu rü ñnũãcü meã i
tucunarichicünaxã, pocuchicünaxã rü
dexchichicünaxã.

Buxũgü rü nüëchama yocuxũ
nguepataxũwa nangedü, nanawa
naũxũ i ngëma nagu rü ñnũãcü meã i
nuxũ.

Tomaëxpüxgu nitoyechapaxagü i
buxũgü.

Wüxichapaxa i buxũgü
tucunarichicünaxã nachaugü.

Taxrechimaũ i buxũgü ägümücügu
tüxnayocugü i tucunarichicünaxã.

Tomaëpüxchimaxũ meã nananugü i

noxrũ puracü.

Nüxna tacuaxãchie i ngëma i ügüxũ.

¿Texé tüxũ tarüngüxë?

Nguexëteruũ rü buxũgü.

¿Ngextá tana ü?

Nguepataxũwa.

¿Taxcü tanaxwexe?

Poperaarü yocu.

Wüxichigü i buxũ rü nanagüane rü wenaarü meã nananu i ngëma nagu tüxũ rü ñnũxë.





Chauega:

Taxīnūcaxwexegū nawá i yuxgūtegū

Nguexēteruū nagu i ūxū

¿Nawá i yuxgūtaegūxū rü naīnecūwá nangēma?

Itachoxū rü wūxi papamaxā tanaxü i toxrü yuxgūterūxū.

Ngēmawena mea nayanaīxgū
naxīnütamaxā nangemaacü nawa narü
togü rü ñuxmachi nayuxgūtegūxūcax i
buxūgü.

Nügü naxügü i buxūgü.

Nawoegu i nguepataūwá rü ngēma
īnūcaxwechiga nidexagü .

Nanangāxū i cagü.

- ¿Nguxāmayi īnūcaxwexegūxe?
- ¿Ñuxācū cugūgu cuxrū īnū?
- ¿Name i cuxcax i ñaa īnūcaxwexe?

¿Texēgü tūxū tarūngūxeē?

Nguexēteruū.

¿Ngexta tanaxü?

Nguepataūwá.

¿Taxcū tanaxwaxe?

Yuxgūtaerūxū.

Naūxchicūnaxā rü nachaxu i wūxi nachametü ngechaūxū rü taaxē rü ngēmawena camücügūmaxā nachiga i dexa nanaxūxū i pora.





Chauega:

Nachiga tidexagü i nguxüma puracugü

Nuxacü ta puracü:

Taboxchimüxügü nangēmaācü yigümaxā i inücaxwexegüxücax.

Nguxüma i puracü i pituxuarü tawemacü i.

Nguexētaruxüarü ngüxēmaxā rü tanangāxü i cagü.

- ¿Taxcüarü puracü taxü i tupanachigagu?
- ¿Texe tüxü tarü ngüxēe?
- ¿Ngexta netaxí?
- ¿Toxrü popera i puracürüxüwa?

Tanaxü i puracü i ngēma puracürüxüwa nüxü a ú.

**Nguxüma i puracü i tupanachigagu i üx rü nüxna nacuaxāchi nataxcü
cuxü. Tapuracüe ngechaüācü, tanaüxchicünaxā rü tanachauxgü ngema
tüxü guchaüxü.**



Three horizontal dashed lines for writing practice.





Ticunagüarü mueta



A large, empty rectangular box with a teal border, intended for a drawing or illustration.

Chauega:.....

Tüxiraüügü i ticunagüarü ngexüügü Mowacha rü Aicüna

Nguexëteruü nagu i ü

Mexā tarü inüxē taxre ngexüügüchiga Aicüna rü Mowacha.

Nüxü taxīnü i nachiga.

Nachiga tidexagü nataxcüchigaxü a uxü. Nüxmachi tanangaxü i cagü.

- ¿Ngexta nangoxe i taxre ngexüügü?
- ¿Taxcüarü cuaxmaxā naixrae.
- ¿Taxcüarü mueta tüxü nacuaxe?

Taunagüchacüxü idexachaxügu, nangaxügu, nachiga i ngēma nüxü inüxü.

Naguxügüraü i mueta ngeri, pexchi rü taxwechigu.

Nüxü tacuax Mowacha rü Aicünaarü mueta natama nawüxigu.

¿Texe tüxü tarüngüxē?

Noxē.

¿Ngexta tana ü?

Nguepataüwa.

Naüxchicünaxā i mueta cuxü mexēchi.





Chauega:

Tuxũarũ ngoxchiga

Nguexẽteruũ nagu i ù

Tuxũchiga tarũ inũxẽ:
Nuxcũma tuxũ rũ nataxuma ga ñaã
naanewa. Wũxi nguxnexũgu ga yoxĩ
dũxwa naẽne ga Ipimaxã nanu.
Yerũ nangẽãxẽũchi rũ guxũraũxũ naxũ
rũ toicaraũxũmaxã nawaxmare.
Rũ yemacax ga Yoxĩ naĩxnecũwa
nayatax, marũ nayauanegu ga ipi
naĩtanũwa daxũ naxĩ, rũ yema nape
ga ñuxre ga ngunexũ, rũ yema namaxũ
ga Ipi.
Wũxichigũ ga werigũ naxũtagu
narũwachigũ rũ ñanagũrũ nuãtanange i
ngẽma orix cungoxũ.
Rũ yemacax dũxwa nagu narũĩnũ
nañuxãcũ inaĩxũ ga naĩxtanũwa.
Ipi ñanarũgũ, tuxũta chaugũ chixũẽ,
nangẽmaacũ icharũĩxũcax.
Yexguma marũ ngaxũnegu yaxũgu
rũ yema nayayutũ guma naĩxarũ

ngãxũnewa, yerũ yema nixĩ ga
oxiarũ ñnũ. Ipi rũ toxũũ nayanguxuchi,
nangẽmaacũ tuxũ yema narũ ù.
Nacutũwa narũ ùgũ ga tuxũ. Ngẽmaca
nixĩ ticunagũ namaxã namuetagũ.
Cagũ nangaxũ.:

- ¿Taxcũ nangupetũ Ipimaxã?
- ¿Ngexta nenaũ ga tuxũ?
- Taxcũ nayanguxuchi.

Nachiga tidexagũ.

¿Ngextá tanaxũ?

Nguepataxũwa.

¿Taxcũ tanaxwexe?

Tuxũchiga.

Nũxchicũnaxã naĩxnewa tiñaxcuchi.





Chauega:.....

Naxīarū yaxu

Nguexēteruū nagu i ū

Papagū rü naxī nguepataūwa tanangēgū rü ngēma nachibüe.

Nüxū narü daunü nañuxācū naxī tawaixgū.

Nayaxugū i ngēmaūgū rü nanamexēanegū nawena nanachibüe.

Papagū rü nguexēteruūmaxā nidexagu nañuxācū nawaxi i naxī.

Nangaū i cagū.

- ¿Ngexta nawaxiū i naxī?
- ¿Nuxre tanuxcūe naxīarū yaxugu?
- ¿Nuxre ngunexū nipax i naxī?

Poperaatü tūxū tinu puracūruū.

Nüxū niugū nanañugūraū naxūpa nanawa.

Nüxū niugū nanguxetūxūgu napaxgū i naxī.

Nüxū niugū nañuxgūraū ngēxguma a pagūgú.

- ¿Nuxgu tanayaxu i naxī?
- ¿Texe tūxū tarü ngūxē?

Papagū rü buxūgū.

¿Ngexta tana ū?

Nguepatawa.

¿Taxcū tanaxwexe?

Naxchiruarū pagūruū.

Nauxchicūnaxā rūia dexcuchi naxūpa nanapax rü marū a paxgu.



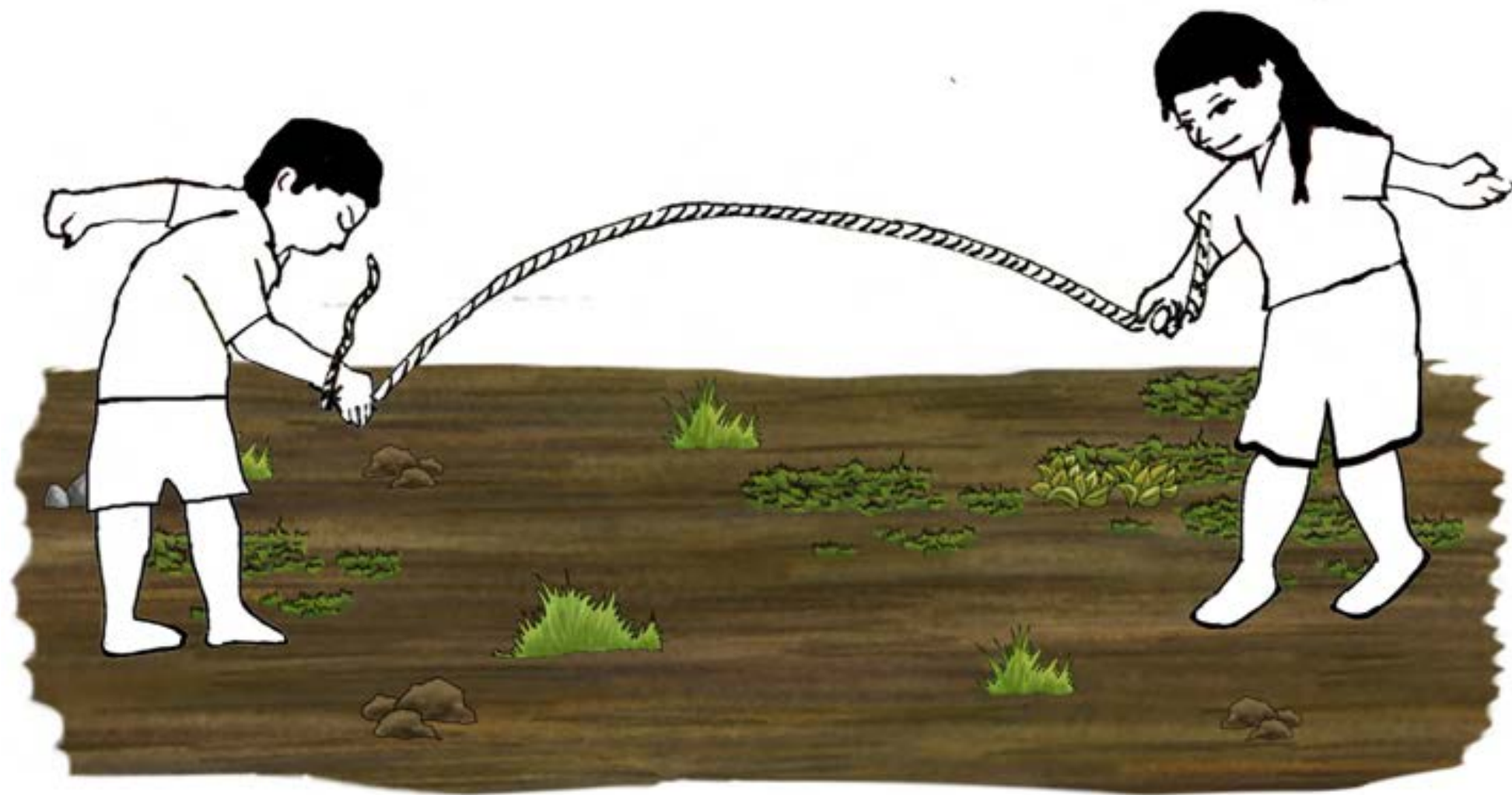

Chauega:

Naixnũtaarũ yuxpetũwá taĩnũcawexegũ

Nguexẽteruũ nagu i ũ

¿Taxcũ naũgũ i buxũgũ?

Naĩnũcawexe namaxã rũ
tayuxgũtexegũ.

Nayuxgũtexegu nawa i naixnũta. Nũxũ
nachaxugũgu rũ narũ ĩnũẽ noxrũ
maxũne.

Nũgũ narũ daunũ rũ guxũma
narũyuxtanũxũ muxẽpũxcũna, rũ wena
narũ ĩnũ ya noxrũ maxũne naporaãcũ
napuracũ.

Nacagũ rũ narũ ngũe,napexetũgũ
ñuxmachi naugũ nanuxãcũ naãga ya

noxrũ maxũne.

¿Texé tũxũ tarũngũxẽ?

Papagũ.

¿Ngexta tana ũ?

Ĩãxtũwa.

¿Taxcũ tanaxwexe?

Naxĩnũta.

Naũxchinaxã nangexta nangẽxma a curũ maxũne i paxũne.



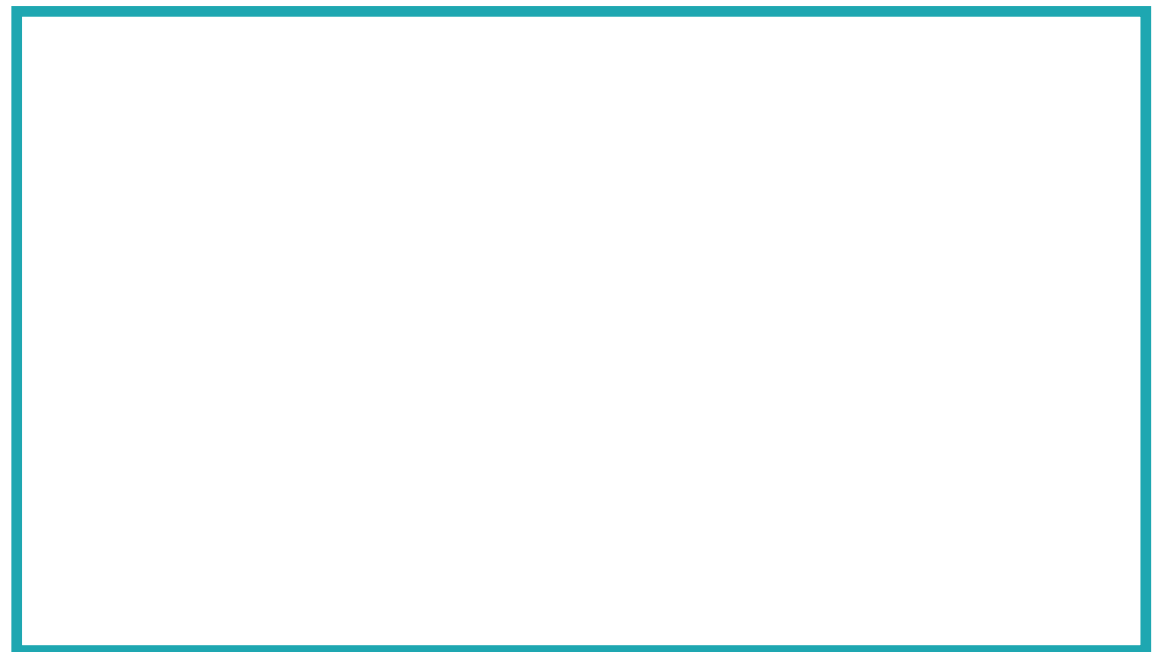
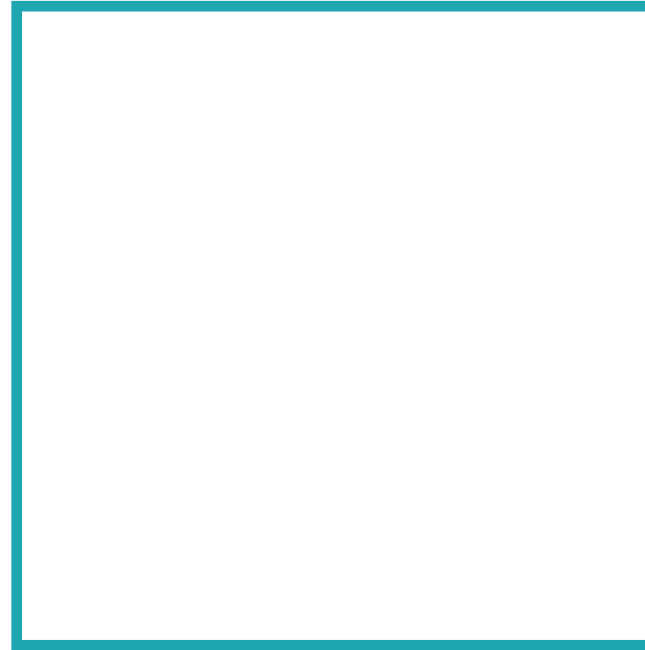

Chauega:

Naxīpawewaátauxwechigu tataü

Nguexēteruü nagu i ü

¿Taxcü naxüe i buxũgü?

Naxīpawe nguēpaüwa nangegü.

Naxīpawemaxã nügümaxã nitoyegü.

Naxīpawemaxã guxũraü naxchicünaxã
inaüxũgü.

Wüxi rüexna yexera taxwechigu naxü,a
ugü rü ñuxmachi naüxchicünaxã.

¿Texé tuxü tarüngüxë?

Papagü.

¿Ngextá tana ü?

Īaxtüwa.

¿Taxcü tanaxwexe?

Naxīpawe rü naxīnüta.

Naüxchicünaxã i naxīpawewá nanañuxraügxü.
cumücümaxã a ugü nañuxre i nguxü.



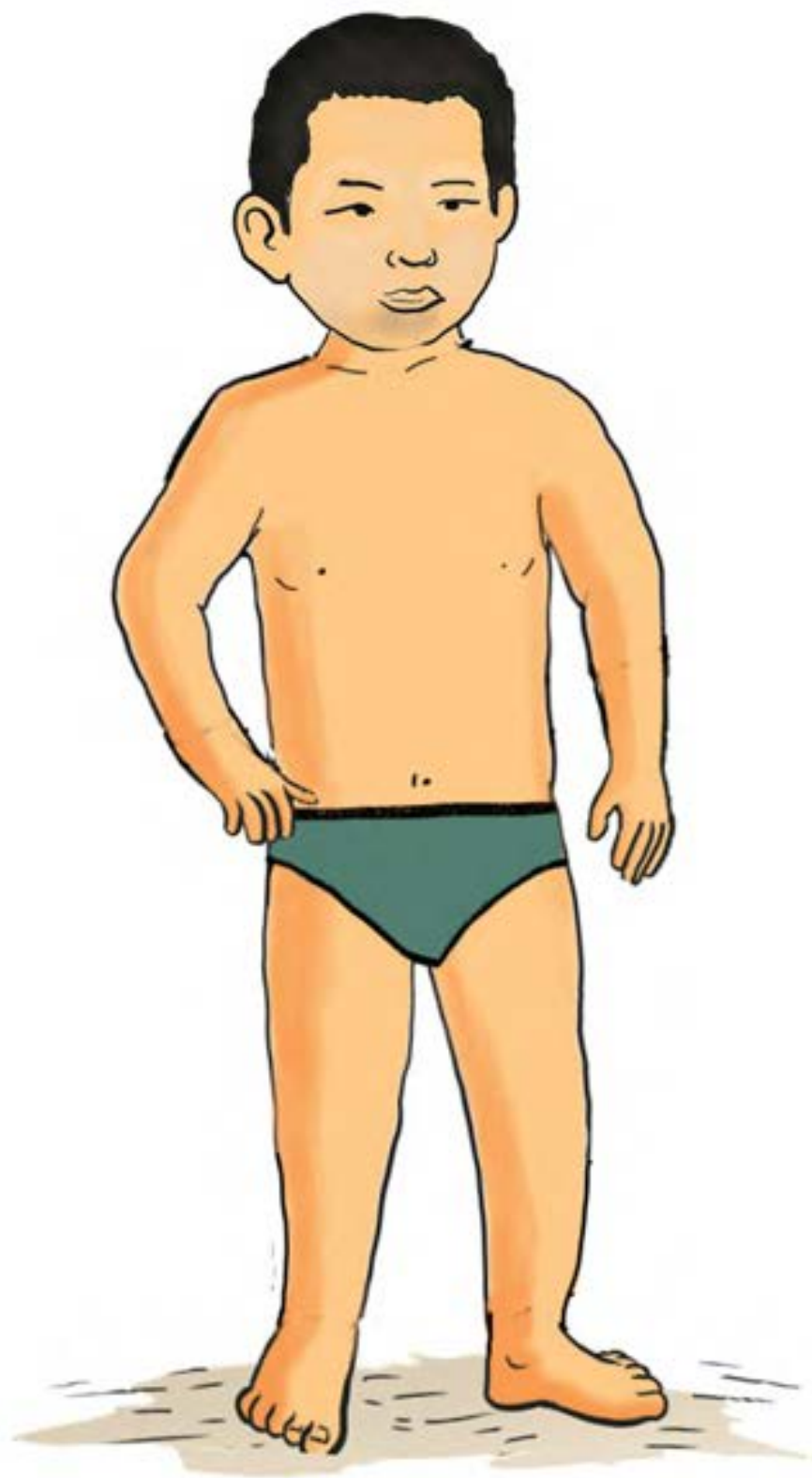

Chauega:

Naxīnūta i āxēēarū īnūcaxwae.

Nguexēteruū nagu i ū

Wūxi papa nguepataūwa naxīnūta nange rū nūxū nixu nañuxācū naūā.
īnūca namaxā taxū i naīxnūta, nūxū tatugū, ātapechicūnaxā, nayugūtanū.
Naīxnūtawa nayugūtaegū, marū nūxū nachauegu rū noxrū maxūne narū īnūē.
Nūxū nacuaxgū nañuxre naaiyagū.

Nayunagūtanū rū wena narū īnūē i noxrū maxūne.

Nacagū, napexetūācū narūngūgū.
Nūxū nixu nañuāxcū naāga i noxrū maxūne.

¿Texe tūxū tarūngūxē?

Papagū.

¿Ngexta tanaxū?

Īātūwa.

¿Taxcū tanaxwexe?

Naīxnūta.

Naūxchicūnaxā nangexta nangemaxū i curū maxūne.



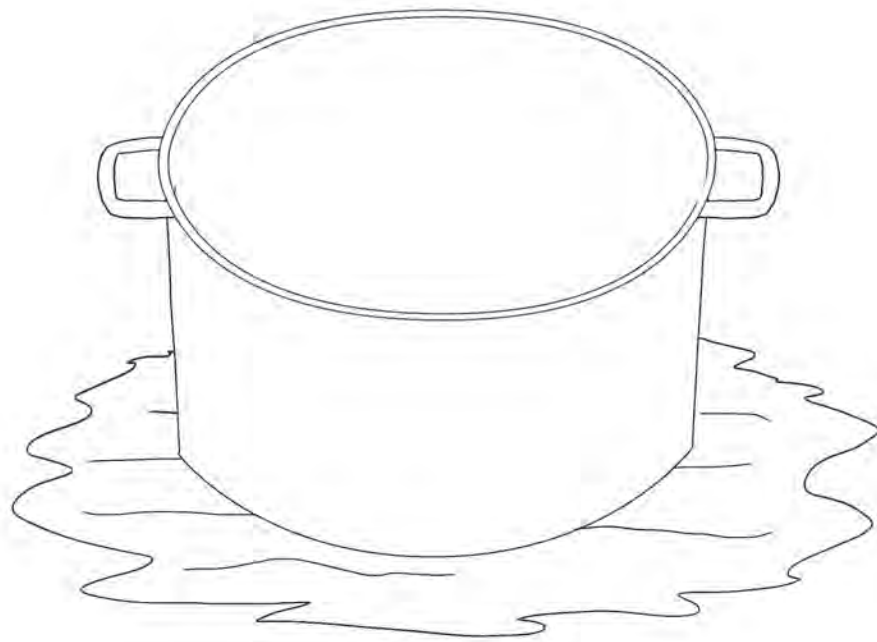
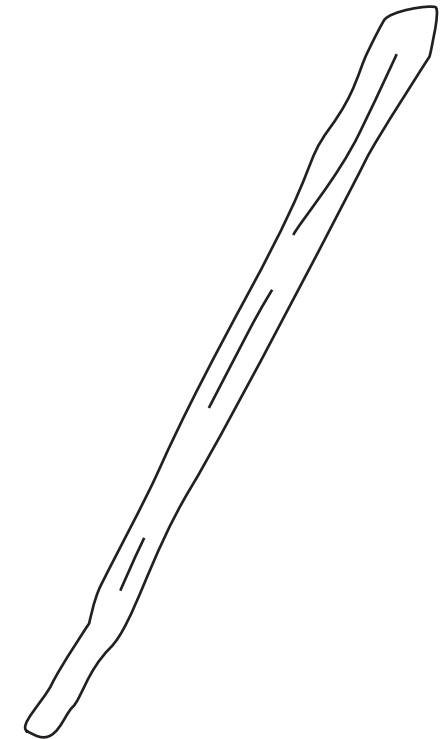
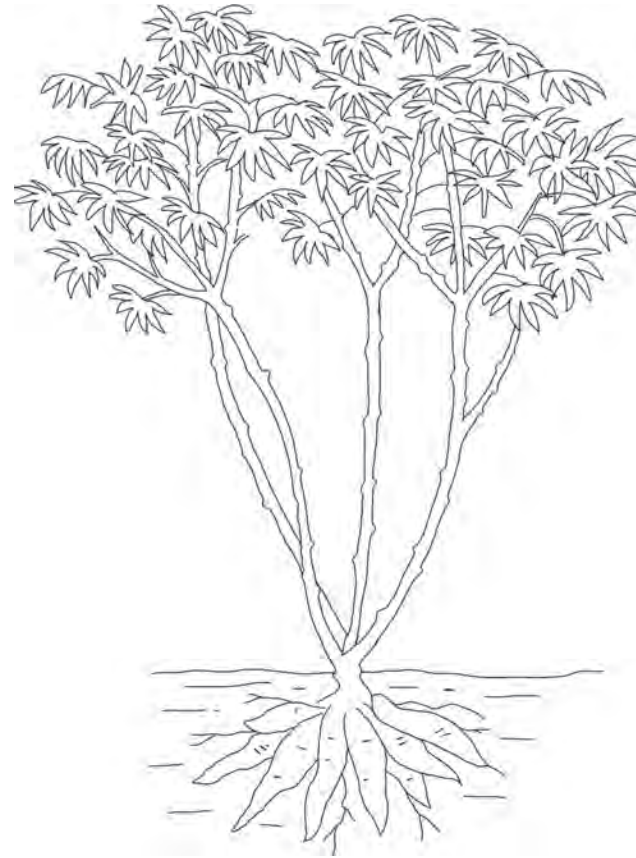
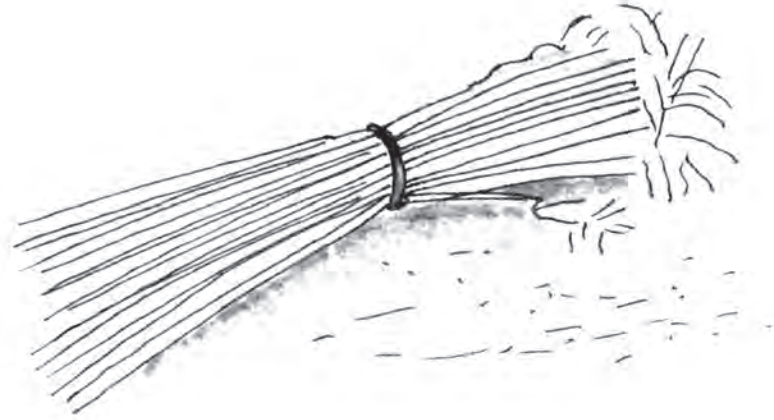
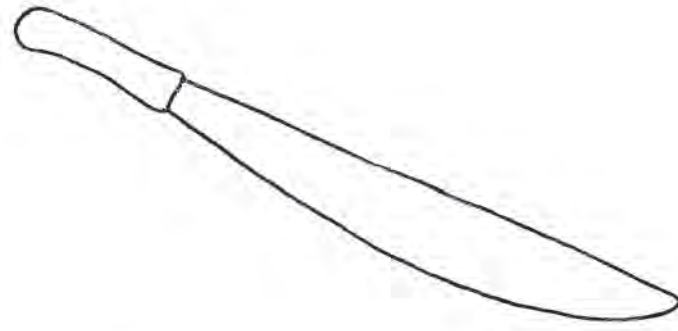

Chauega:

Naxī tichauxgü

Nguexëteruũ nagu i ũ

Naxīarü chauxgüruũ iningëgü i buxũgü.
Yigü meã tanuchapaxagü, nanaxī
ichauxgü.

Taxre ngunexũ namaxã tanguxũ i
naxī nameã nawa a ãuxũcax i noxrü
chauxgüruũ.

Moxũãcü tanayaxu rü tanapa.

Nguexëteruũ cagü naxü nawana i taxre
ngunexũ:

- ¿Taxcümaxã naxī tichauxgü?
- ¿Texearü ngüxëmaxã tachauxgü i
naxī?
- ¿Ñuxre namatü inanguxuchi?
- ¿Taxcü naxīmaxã nangupetü i
temperamaxã nachaxugu?

Buxũgü nguepataũwa nanangegü
naxīarü ümatüruxũ.

Wüxie mamana naugü.

Yigü tamexëgü naxca nanaümatügüxũ,
bachiagu tanaü.

Ñuxmachi nawa tanawoxũ, rü ngëma
nangëxma taxre i ngunexũ.

Ñuxre itaüxüchi, i naxī natemperamaxã
achauxgüxũcax.

NüXũ nadaugü i ngëma naxī namaxã
naümatügü.

Nguexëteruũ ñuxre cagü naxü.

¿Taxcü tanawexe ega naümatügu?

¿Texe tũxũ tarü ngüxë?

Mama rü buxũgü.

¿Ngexta tanaxü?

Nguepataxũwa, ãxtüwa.

¿Taxcü tanaxwexe?

Namatügü, dexpaũ, e, naxīcu, menecü,
õxũ, rü toamachigü.

Nachaxu i naxīchapaxa ngëma nuã nangoxũãcü rü imayoxũ.





Chauega:

Wüxie papa cotu i muëxütawa taxī

Nguexëteruũ nagu i ũ

- ¿Taxcü naüğü i buxüğü?

Papa cotu i muëxütawa taxī.

Nachiga nidexagü napapa i muëtaexütawa nanaĩ.

Nüxna nacuaxāchie i nacüma i ngëma a nguëgüxü.

Tachoxü rü tuxü tarüdaunü ya papa i muëtaxe.

Nguexëteruũ cagü taxü.

- ¿Ngëxta netanange ya cotu?
- ¿Ngëxta narü ügü?

Buxüğü rü cagü nangaxügü.

Buxüğü rü papa i muëtaeü narü ngüëxëgü noxrü āwa ya cotu.

Nguepataüwa nüxma nacuaxāchigü i ngëma naüğü i muëtawa.

Buxüğü, nguepataüwa nanangëgü i naxīarü ümatüruxü.

¿Texe tuxü tarüngüxë?

Papa, buxüğü rü nguexëteruũ.

¿Ngexta tana ü?

Īxätüwa.

¿Taxcü tanaxwexe?

Cotu, yurachipanü.

Tanayoxochi i ngëma nagu naxü i muëtachiga.



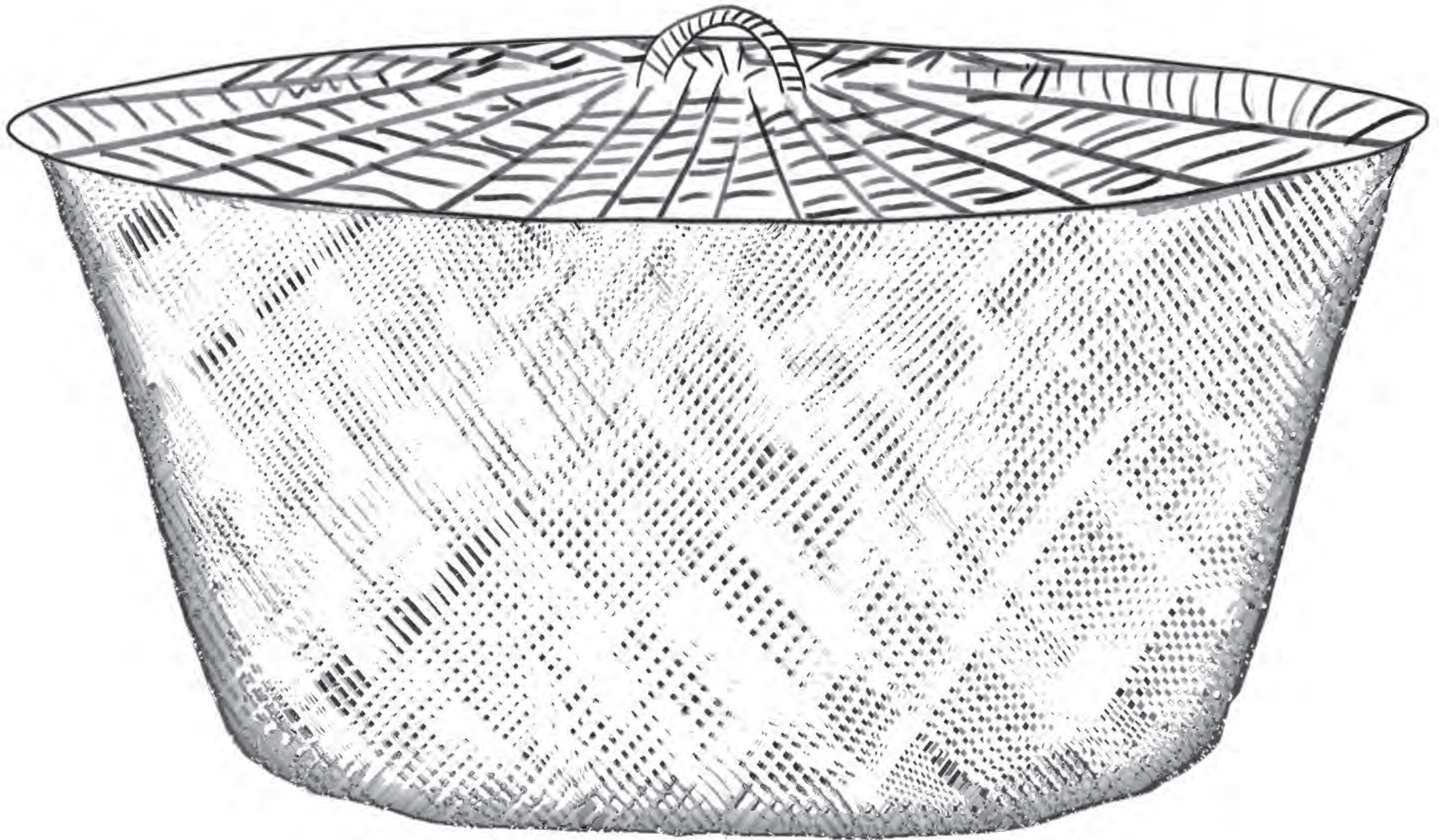

Chauega:

Nüxütacuax naguxüügüraü i muëtagü

Nguexëteruü nagu i ü

Taxcü naüügü i buxüügü?

Nüxü tañü nachiga i pagüëxcha.

Buxüügü rü nguepataüwa nanangegü
naguügüraü i ngemaü i naxī rü
dexpewa i ü.

Wüxigu tananu i ngëmaxü i marü
dexpewa i mu.

Nüxü narü daunü rü nüxü nadaugü.

Nanangugü namaxā i natoraü i
muëtagü.

Nüxü niuchigagü i naxīwa naüügü i
muëtagü rü naüegagü i wüxichigü.

¿Texé tuxü tarüngüxë?

Buxügu.

¿Ngextá tana ü?

Nguepataüwa.

¿Taxcü tanaxwexe?

Ngëri pexchi, pacara, tipiti, wotura, rü
toamachigü.

Nachaxu naxīwa ügü i muëtagü rü inawüeü.





Chauega:

Naxīarū āxū ngexriarū ngaicax

Nguexēteruū nagu i ū

¿Taxcū naüğü i buxūğü?

Wüxi mama tūxū tanguxē nañuxācū
naxāūxū i naxī taiāxgü.

Nüğü namexēgü nacax i naxīarū āxū.

Mamaarū nguxē naüğü nanaāxgüā i
naxī.

Meāma naāxnüta ū rü nachiga ti
dexagü.

¿Texé tūxū tarūngüxē?

Buxūgü.

¿Texé tana ü?

Nguepataūwa.

¿Taxcū tanaxwexe?

Ngēri.

Nachaxu i naxchicünaxā i naxī marū āxnüta.





Chauega:.....

Nachiga tidexagü i guxüma puracugü

Ñuxäcü tapuracü

Taboxchimaxügü nangëmaxäcü yigümaxä i inücawexegüxücax.
Guxüma i puracü i tawemücü i bawechigaarütawemücügu i ü.
Nguexëteruñarü ngüëmaxä rü tanangäxü i cagü.

- ¿Taxcüarü puracü taxü i tupanachigugu?
- ¿Texe tuxü tarü ngüxëe?
- ¿Ngexta netaxi?
- ¿Toxrü popera i puracürüxüwa?

Tanaxü i puracü i ngëma puracürüxüwa nüxü a ú.

Guxüma i puracü i tupanachigagu naügü rü nüxna nacuaxächi nataxcü naxü. Tapuracüe ngéchaüxäcü, tanaüxchicünaxä rü tachauxgü i ngëma tuxü guchaüxü.







Ticunagüarü üwechicüma

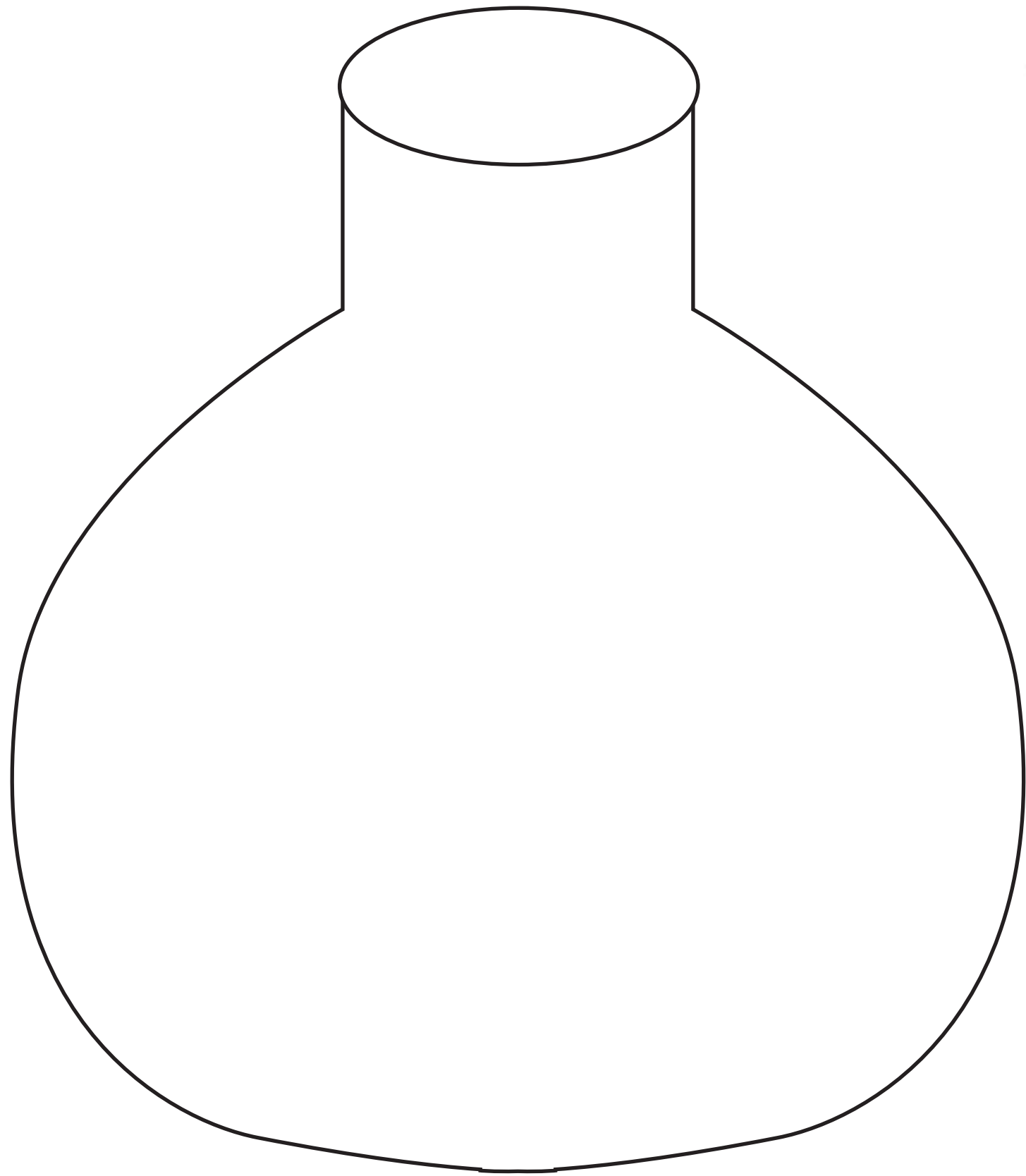

Chauega:

Nüxü tacuax i ticunagüarü nacaxä

Nguexëteruü nagu i ü

Buxügü nachiga nidexagü rü nüxna tacuāxchi i nacaxāchiga i ticunagü.

“Yoxi ticunagüxü naücaxāgü, tūxü nanangōxechigü i chenemaarü namachi rü ixraxü natūxü, yexguma tūxna a āchigügu rü namaxā tayuxnagü rü tagaxācū aita namaxā taxü rü ñatagürü: aiii, naïyüüü. Yemaxacü nanaü ga yoxi. Ngēmaxācū nixī ñuxma ticunagü a ācaxāgü rü nügü nacuaxe nanügütanūxü yixī.” Ngēma nacuax i nachiga.

Buxügü rü nachixüwa noxrü mama na naca natakūcaxā tixī namaümatü, rü naüxchinaxā i nacaxā.

Nguepataüwa meā inarü togü i buxügü, nanayauxgü wüxi naxchicünaxā rü nügücax naxī i wüxigüarü nachicünaxā.

Paperaatü i taxüwa naüxchicünaxā i cucaxā, namecüraxüē.

Nachiga nidexagü nañuxācū yoxi tūxü ücaxāgüxü.

¿Texé tūxü tarüngüxē?

Papa rü oxí.

¿Ngextá tana ü?

Nguepataxüwa.

¿Taxcü tanaxwexe?

Namatü i nacaxāchiga i dexa.

Poperaatü i nacaxāegagümaxā matü.

Naüchicünaxā, nachaxu i nachicünaxā i cucaxā tūxü i ügu.





Patüxũ cumexẽchi
apawá cumexẽchi.
Chaxũchiũwá cume,
patüxũ.

Naxca tague i tũxũchigaguicuxũ.

Nguexẽteruũ nagu i ũ

¿Taxcũ naũgũ i buxũgũ?

Nũxũ narũ daunũ nagugũraũ i nawechigũ,
poratu, tũxũ, axepaũ, churi.

Nanangaxũ i cagũ.

- ¿Taxcũwá namexũ?
- ¿Taxcũwá naxũ?

Nguexẽteruũ rũ tana ũmatũ i buxũgũ
tũmaxã nũxũ i ugũ.

Namaxã nũxũ tixu nawũxi taũmatũ i wiyae
nachiga i nawechichiga nañuxãcũ naxũ.

Nacax nanguue i poesia rũ nũxũ nixu
nataxcũchiga yixĩ.

¿Texé tũxũ tarũngũxẽ?

Buxũgũ rũ nguexẽtaeruũ.

¿Ngextá tana ũ?

Nguepataũwa.

¿Taxcũ tanaxwexe?

Nawechigũ.

Inawũegu i tũxũ ngemaxũchiga duũxũgũpexewa i ũxũ.



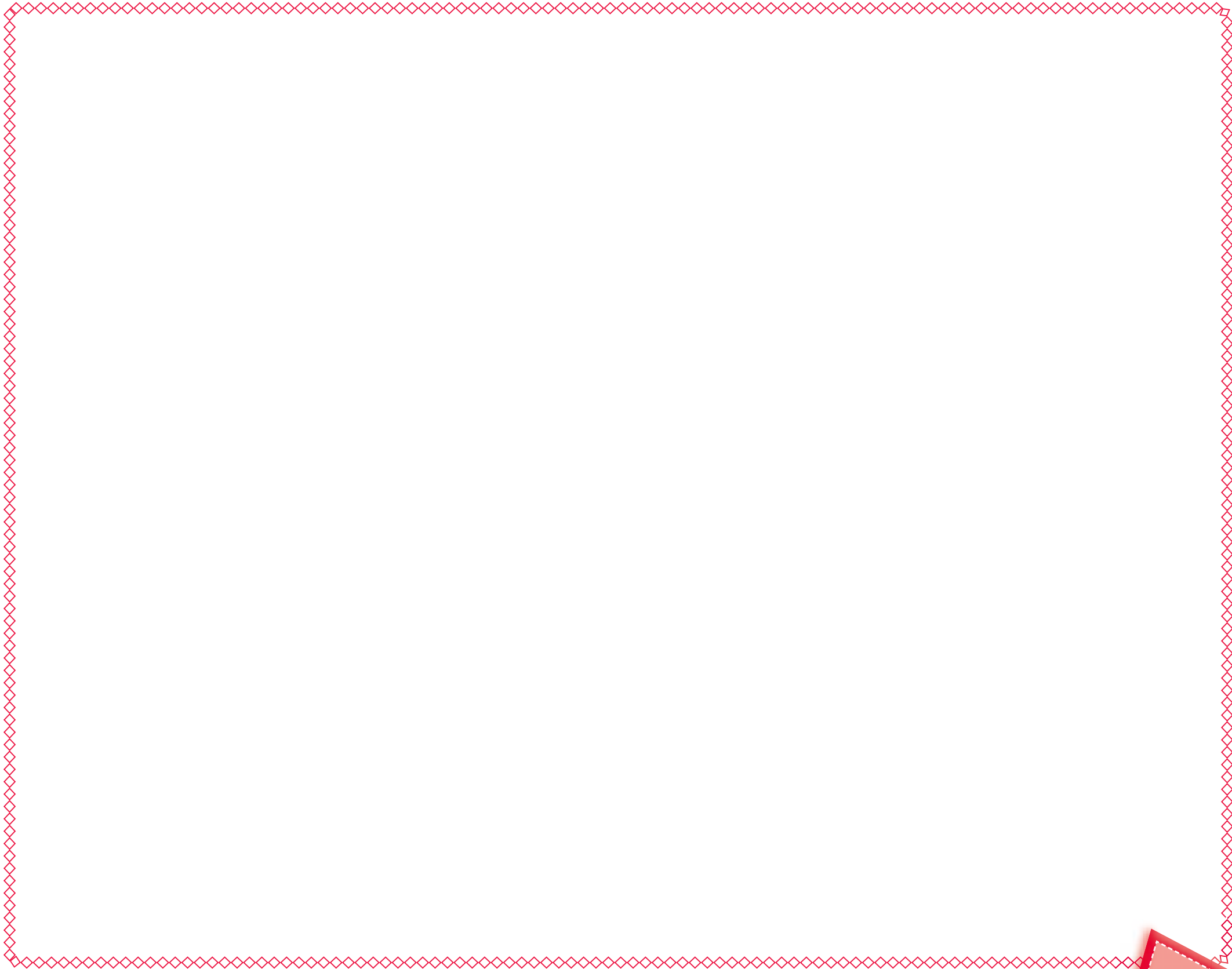

155

Chauega:

Ngemaxũgũ tanutaquexe nawechiarũ ücax.

Nguexëteruũ nagu i ü

¿Taxcü naũgũ i buxũgũ?

Papa rü noxë nüxũ cuaxe nawa taxĩ i oxtachara natüpechinüwa rü ñuxmachi puru, õwüchire rü

nguepataũwa nananagũ. Buxũgũ rü tama ngëma naxĩ erü nanatü nüxma naütanüega.

- ¿Taxcü naũgũ i buxũgũ?

Nüxũ narü daunü rü ñuxmachi nüxũ nadaugũ i ngemaũgũ i noxë, papa rü nguxëtaeruũ nawa ĩ.

Nüxũ narü daunü na ñuxãcü a guxũ i puru.

Taxre mamagũxũ narü daunü nañuxãcü tanaüëũgũ a oxtachara mamaxã puru.

Nũgũ nitoyechapaxa rü nanayaxugũ i oxtachara rü nanaũgũ naguxũraũ i naeũchixcünaxã.

Cagũ tangaxũ.

Nanangaũ i cagũ.

¿Taxcü nangupetü ngëguma toxarü tanimacamaxã naüëũgu i oxtara? ¿Ñuxãcü tana tacharaeũ i oxtachara?

Nagu narü inüe naguũraũ i werichicünaxã naũgũ namaxã i oxtachara.

¿Texé tũxũ tarüngüxë?

Mamagũ.

¿Ngextá tanaxü?

Nguepataũwa.

¿Taxcü tanaxwexe?

Poperaatũ, taxũ, chaeata ruxũ.

Naüëũ i plastilina ñuxmata nawarachara rü tanaũäcu ya tũxũ rü buri.





Chauega:

Taugü i bopüxügü i waximüwa ügü

Nguexëteruü nagu i ü

Taxre nügümaxã naãmücügü rü nügüarü wexwa narü togü.

Nanayaugü i iraü i oxtachara.

Naañumücharagü rü iraü i bopuxügüü inaüügü rü wüxigu naãdaxchimüüëgü.

Nanangugü nañuxre bopüxgüü ngëma wüxichigü i büxü.

Buxü i noxrearü bopüxüã rü togue tuxna nanucu ñuxmata togüarü mumaxã tawüxigü.

¿Texé tuxü tarüngüxë?

Buxügü.

¿Ngextá tanaxü?

Nguepataüwa.

¿Taxcü tanaxwexe?

Oxtacharawa i üxü i bopüxüchiacü.

Naüxchicünaxã i muxüma i bopüxügü ñuxmata namaxã nawüxigu i dauwa ngëmagüxü.



A large, teal-outlined speech bubble is positioned to the right of the woman. Inside the bubble, there are four horizontal dashed blue lines, providing space for writing a response.

Chauega:

Taxcū taxū ega i oxtaegu

Nguexēteruū nagu i ū

Naūxchicūnaxā i muxūma i bopūxūgū
ñuxmata namaxā nawūxigu i dauwa
ngemagūxū.

Nūna tacuaxāchie i ngema i nguxē i
choūxūcax.

Tūxū tarū moxēgū.

Tūxū tarū inūe nañuxācū maxā i dexta i
oxtachara nanatū i naxchirūcax, rü nacax
ngema tana ū i tūxūacū, poratugu ixraū i
oxtachara ngemataā i yaxu rü ngema i ū.

"madre de la greda ahora "Pa nanatū

cuxna nacax chaca i ngema choxna cuāxū
nameā choxū inanguxuchixūcax."

Wena nūxū naūgū.

Nguepataūwa nayaxu i poperaatū rü
wūacūxūruū.

Poperaatū puracūruū nayaugū.

¿Texé tūxū tarūngūxē?

Nūxū cuaxe.

¿Ngextá tanaxū?

Nūxū cuaxechiūwa rü nguepataūwa.

¿Taxcū tanaxwexe?

Poperaatū, taxū, chaeata ruxū.

Ngexe nūxū fixu i ngema i ū rü nanaūmatūgū.





Chauega:

Nawechigü tuxũ itagu.

Nguexeteruũ nagu i ũ

Narũ inũe nachiga i ũwechi i nguxetaeruũ tamaxã nawa daumatũte.

Noxẽ "Ericha nũxũ nacuax nanaũwechi rũ nanaũxũ i mexcũraũ i tũxũgũ. Ngẽguma marũ namexgu rũ nacax nadau i nachica nangẽta inagũ. Ngẽma nananu, ũxũ naẽtũgu nanugũ rũ ngemaãcũ nawa nangixichi ñuxmata a ngẽxẽ i tuxũgũ. Noxẽ rũ nũxũ natutugũ namaxã i naĩ nanũxũ nacuaxũcax tamarũ tingẽxgũ.

Nũxũ i ugũ nañuãxcũ naxũ i nawechigũ, naũega cuxrũ inũmaxã.

¿Ngextá tanaxũ?

Nguepataũwa.

¿Taxcũ tanaxwexe?

Oxtachara, pexchi, chacu, tara.

Meã nanu i naxchicũnaxãgũ, nangẽxta naxũgũ rũ ngexta a ngux.



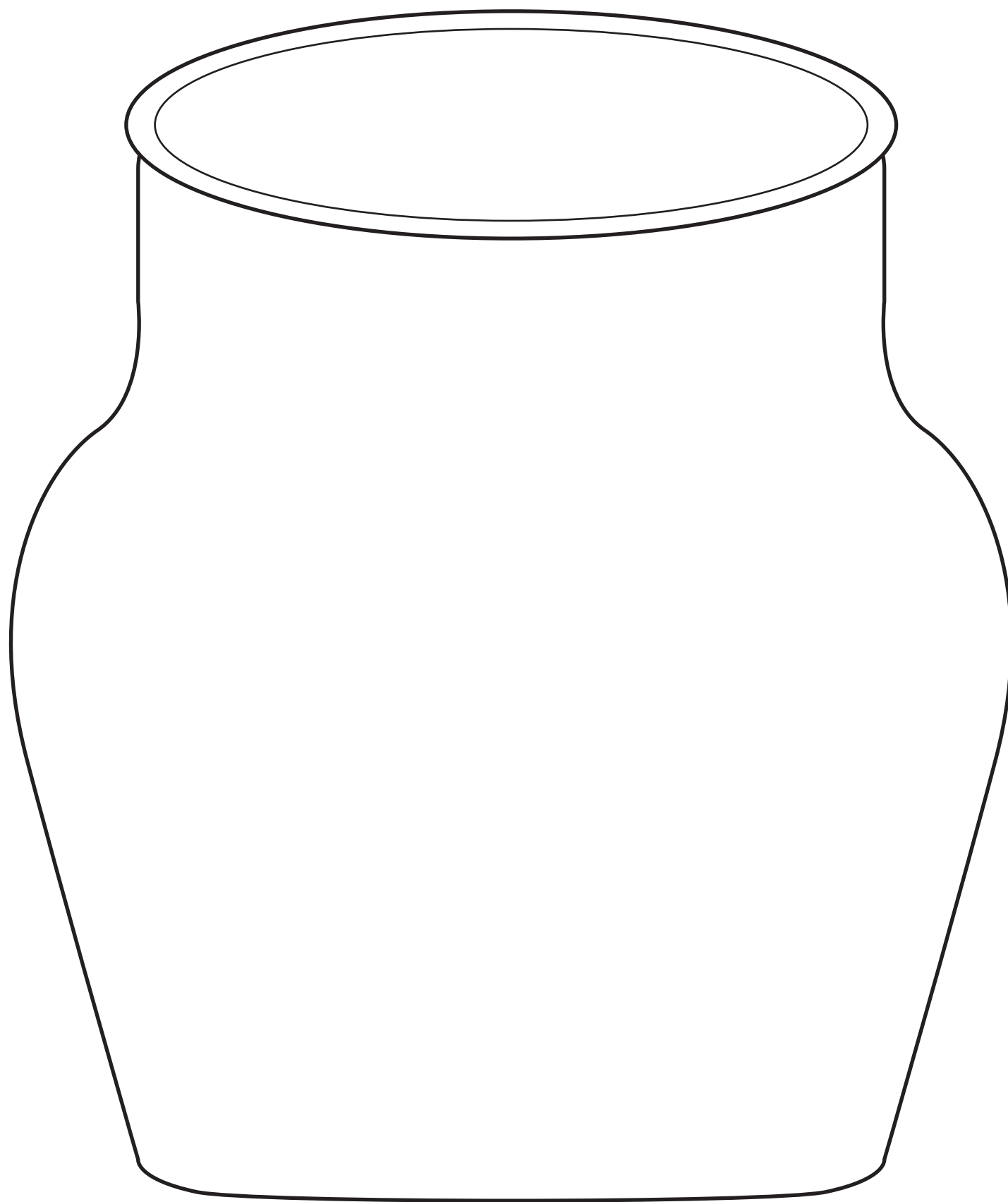

Chauega:

Ngaxwechipexemaxã rü moruchiremaxã tayiracüxü i nawechigü

Nguexëteruü nagu i ü

¿Taxcü tanawexe? i marü i pagü.
Ngaxwechipexemaxã rü moruchiremaxã tayiracüxü.
Narü daunü i wüxiarü yiracüxüchigü nanañuxraü.
Wenaarü tuxü tipaxë ñuxmata tingu.

Ngaxwechipexemaxã tuxü tayiracüxü.

¿Ngextá tanaxü?

Nguepataüwa.

¿Taxcü tanaxwexe?

Nawech, i ngaxwe, moruchire.

Nawechi nauxchicünaxã taxuta i ngu rü marü i ngu.



Three horizontal dashed lines for writing.



Chauega:

Nawechi taūmatū namaxā oxtacharaarū daumū rū naīxācū

Nguexēteruū nagu i ū

Nachiga nidexagū i ūwechichiga rū namaxā nanguxūgū, ngēxta tama i yapuegaūgu. Nūxū narū daunū i namatūgū, ngēma tūxū i oxtacharawa i ū. Īāxtūwa naxī rū naīxācū, tanangaugū rū nanaūgū i naguxūraū i namaūgū.

Waximūgu nanaūxchicūnaxā i namaū meā i wex, ipogūmaū, bexruarū goe rū weriarāgoe. Poperaatū nayaugū puracūruū.

Nanguxēgū i namatū i toxū.



Three horizontal dashed lines for writing.

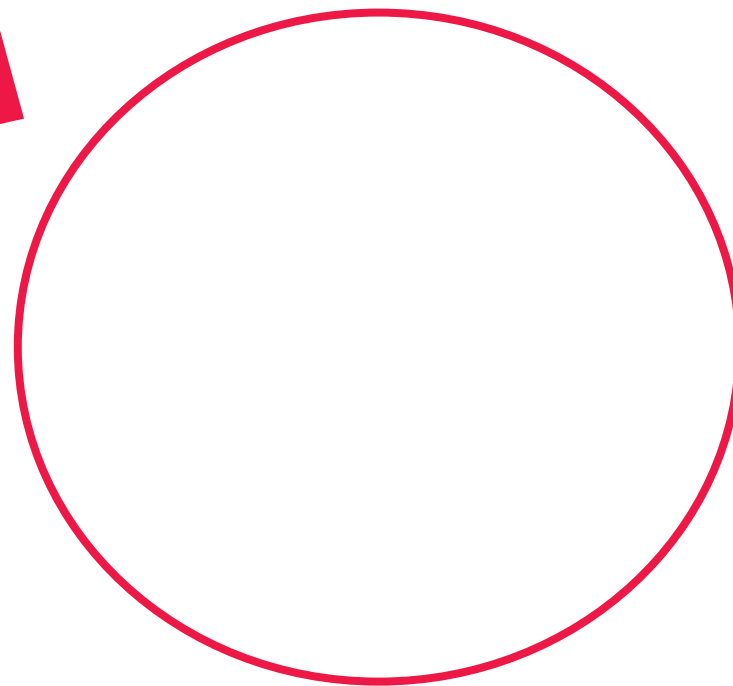
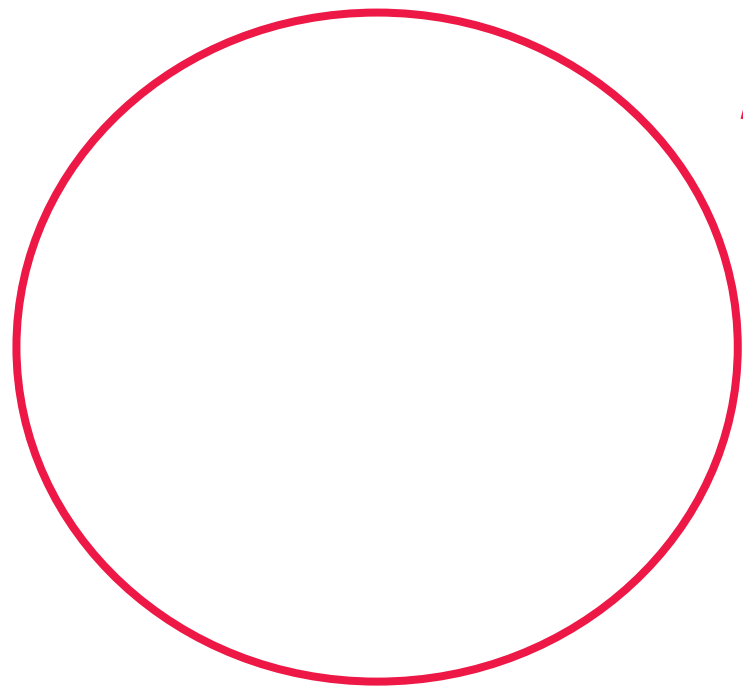
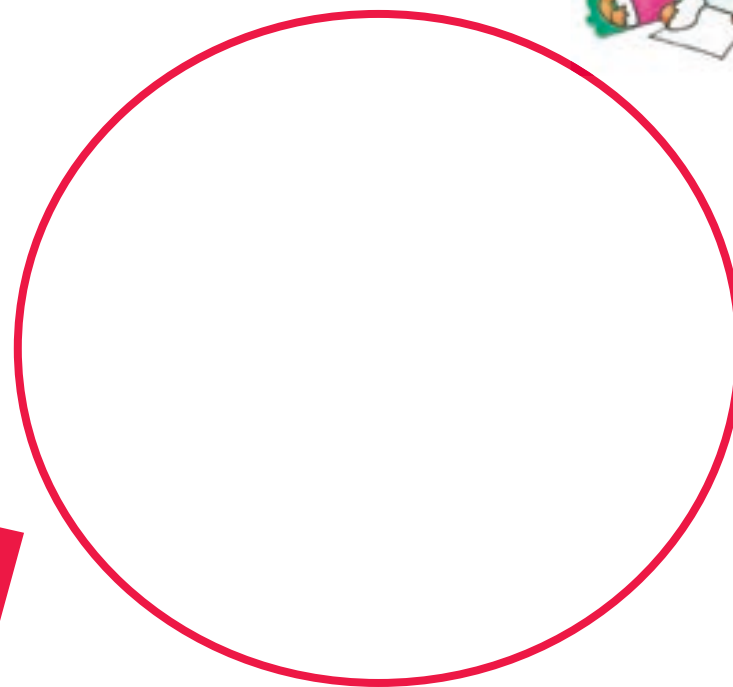
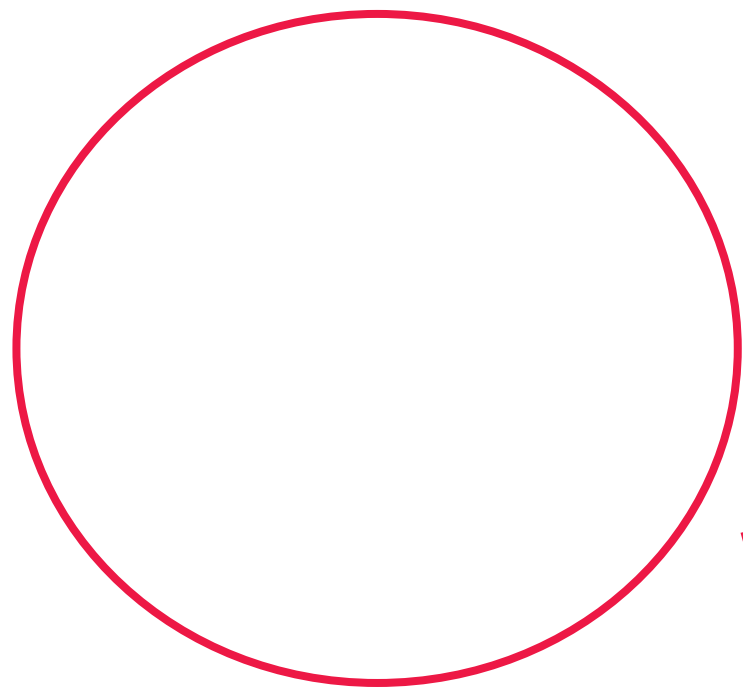

Chauega:

Ngexchigümaxã nawechigüxü tachaxüma

Nguxëteruü nagu i ü

Tümaxütawa taxī ya nüxü cuaxe nangexchigümaxã tüxü tichaxugü i nawechigü, poratu, tachaü, toamachigü.

- ¿Taxcüroxü tama name inücaawaewa?
- ¿Nüxü mexã nadawenü?

Nguepataüwa tama ngaxü ñuxre cagü

- ¿Ngexta nangëma i ngexchi?
- ¿Texe tama to?
- ¿Üxacü tanawexe nanayauxüca ngexchigü?
- ¿Ñuxãcü tana caxü a ngexchi?
- ¿Texe nüxü tacuax natanaxü ngexguma i chixeanügu?
- ¿Taxcü nangupetü ngëxguma namaxã i wawexügu?

Buxügü nüxü niugü naguxüwama namexü.

Ngõxwa.

Üxüwa.

Üwechiwa.

wawexüwa.

¿Ngextá tanaxü?

İãxtüwa, mamaütawa.

¿Taxcü tanaxwexe?

Ngexchigü, ngexchi.

İañaxcuchi nataxcüwa name i ngexchi.





A large, empty rectangular box with a red border, divided into two horizontal sections, intended for writing or drawing.

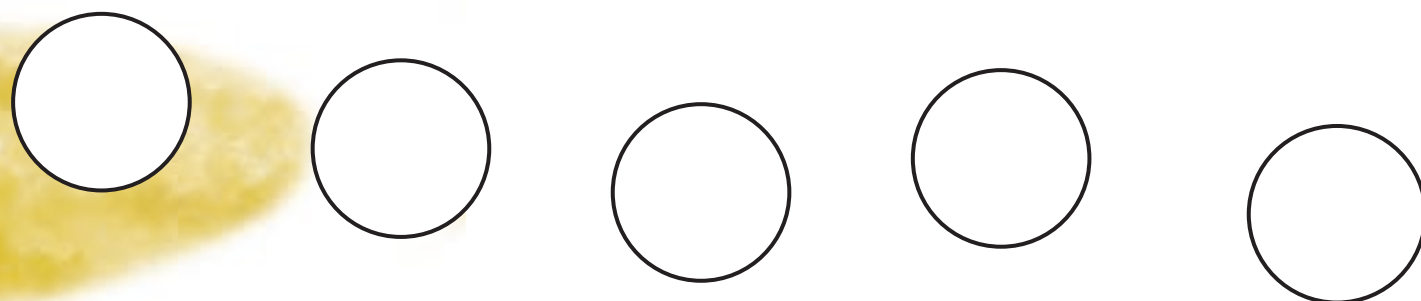

Chauega:

Waximüpüxü i nexi menaxagu üxümaa tainücawexegü

Nguexëteruü nagu i ü

Buxügü rü inachaxü nawaximü i daucharax-
ü taadaugü.

Nügü naüxchimaxü, rü nügü naanu i
waximüchara.

Nanabuxüpüxü i waximü i nümagü
nanawexegüxüācū.

Nügü naügü. Naxīācūpexewa nanāxcūchi
i waximü, ñuxmachi nanaña poraacü noxrü
paramaxā.

Buxügü nacax nadaugü rü nanaüxchinaxā
nangexta nanguxü.

Guxüma i buxügu wüxichimüxü naügü,
nanañagü ñuxre nguepataüwa nangegü.

Ngixā taugü nañuxre buxügü āgümücü
bopüxüü ñagü.

¿Texe tüxü tarüngüxē?

Buxügü.

¿Ngexta tanaxü?

Türewa, ngexta inangēmaxüwa i waixmü.

¿Taxcü tanaxwexe?

Waximü, oxtachara, naixācū.

Taugü i waixmüarü bopüxüü nañuxre yixī. Nawexe na agümücü yixica.



Three horizontal dashed lines for writing.



Chauega:

Nachiga tidexagü i nguxüma puracugü

Nuxacü ta puracü:

Taboxchimüxügü nangēmaacü yigümaxā i inücaxwēgüxücax.

Nguxüma i puracü i tawemücü i tupanachiga.

Nguexētaruxüarü guexēmaxā rü tanangāxü i cagü.

- ¿Taxcüarü puracü taxü i tupanachigugu?
- ¿Texe tüxü tarü ngüxēe?
- ¿Ngexta netaxī?
- ¿Toxrü popera i puracürüxüwa?

Tanaxü i puracü i ngēma puracürüxüwa nüxü a ú.

**Ngucüma i puracü i tupanachigagu i üx rü nüxna nacuaxāchi nataxcü
cuxü. Tapuracüe ngéchaxüäcü, tanaüxchicünaxā rü tanachauxgü ngema
tüxü guchaüxü.**



Three horizontal dashed lines for writing.



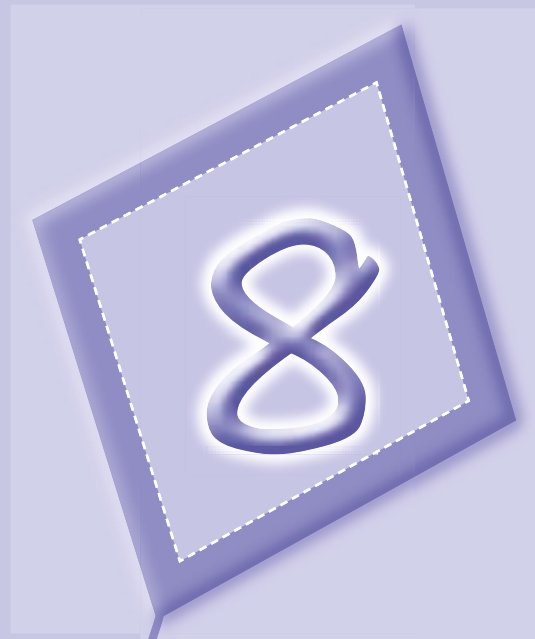

Ticunagüarü cuene
ĩ cüma

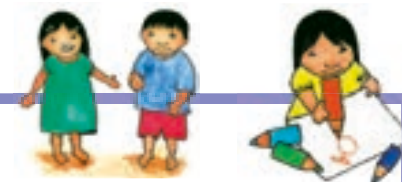

Chauega:.....

Nüxü tacuax i ticunagüarü nacüãx

Nguexëteruü nagu i ü

Nüxü narü inüe i nacüchiga nidexagü

Nguxëtaeruü buxügüxü tanawex i
naxchicünaxã i ngã.

¿Cagü taxü?

Taxcü i naëxü nügü i tugü rü nanangãraxü.

Nguxëtaeruü rü buxügümaxã nüxü tixu i
ngãxchiga.

Marü naguxüchigaü naī u, buxügü rü
wenaarü nügümaxã nüxü nixugü.

- ¿Cagü taxü?
- ¿Taxcüxü nanguxuchi i nawü?
- ¿Taxcüroxü ngã nanawüraxü?
- ¿Buxügü rü wenaarü nüxü
nadaumatüg

¿Texégü tuxü tarüngüxé?

Nguexëteruxü.

¿Ngexta tanaxü?

Nguepataüwã.

¿Taxcü tanaxwexe?

Nacüxãcüchicünaxã.

Naüxchicünaxã i nacüãx nüxü cucuaxü.





Chauega:



Chauega:

¿Ngexta nūxū tangau i naeūgū?

Nguexēteruū nagu i ū

Papa feneetaxena nacagū
natananguēūcax nangēxta rü ñuxācū nūxū
tafax nanangēmaū i naēūgū.

Buxūgū rü cagū naūgū nameā nūxū
nacuaugūxū nañuxācū naēū i fexe.

Papa fenee namaxā nūxū tixu nañomaūcū
marū nataúma i naēūgū ngaicamana, erū
marū namuxūchi i duūxūgū i naī i yegū.

Togū duūxūgū nanafegū i naēū noxrū
ngōxruū rü noxrū taxeruū rü ngēmacax
marū niguxgū.

Nguepataūwa nachiga nidexa ngēma
papa nanguexē.

Nguxētaeruū rü düxetūwa taū
buxūgūmaxā rü ngēma tananu i poperaatū
i naēūcutūchicūnaxā rü buxūgū nūxū niugū.

Nguxētaeruū buxūgūxū naēūchicūnaxā
tawex rü nūxū niugū nangexta namaxē.

Popera puraruū rü piraña tūxū nayaxugū.

Popera puracūruū nayaxugū.

¿Texé tūxū tarū ngūēē?

Papagū nguxētaruū.

¿Ngextá tanaū?

Nguepataūwa.

¿Taxcū tanawexe?

Poperaatū nachitū nawa ngox.

**Inayoxochi i naēūgūchicūnaxā.
Rü ñaxcu, ngexta nachica iaixūwa.**



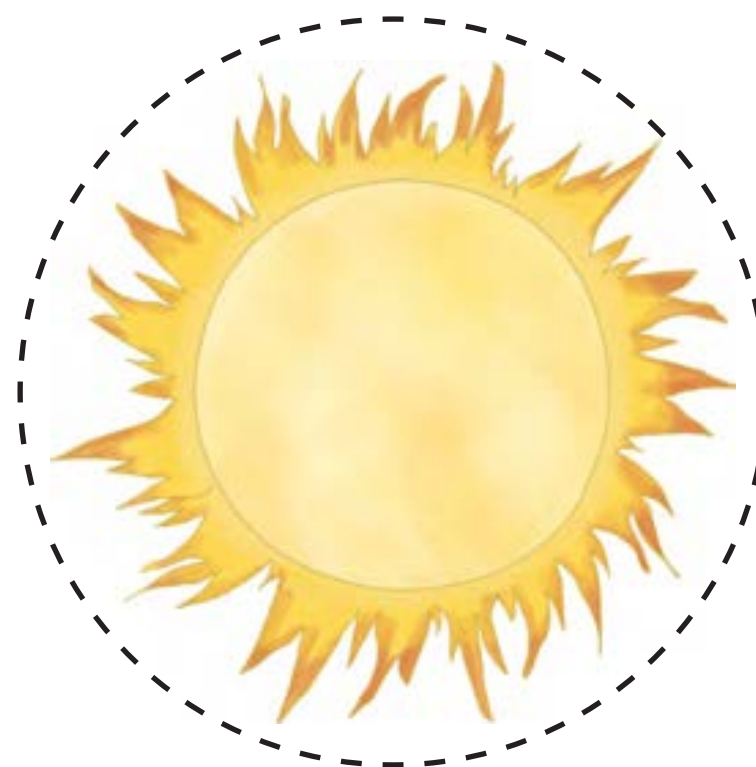
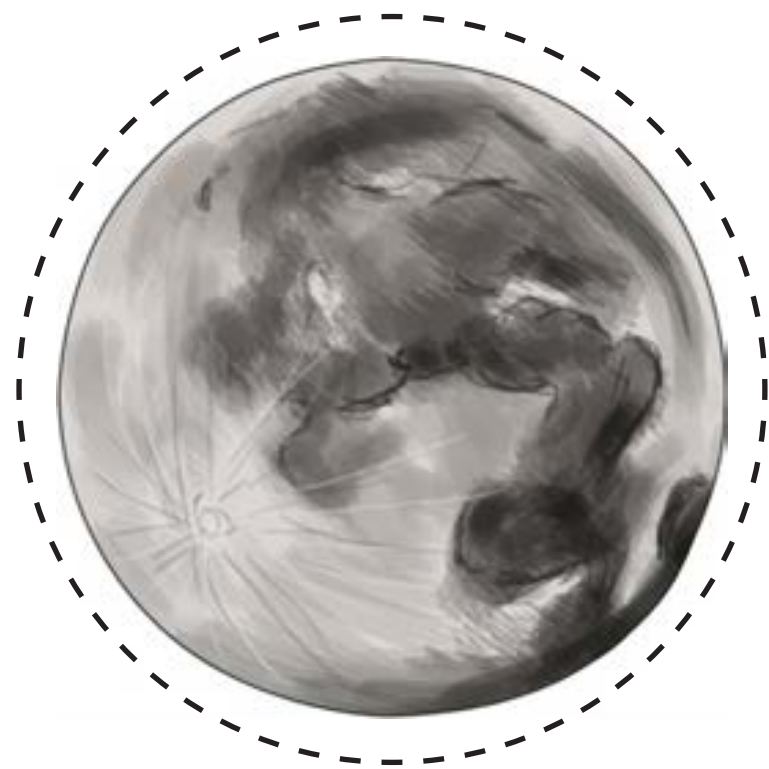

Chauega:



Chauega:

¿Taxcüarü naëüxgü nixī i chütacü rü ngunecü i yaxu

Nguexëteruü nagu i ü

Nguepataü nachiaügu tana inaëüchicüxna rü nuxmachi buxügu na cataü

¿Ñaa naëügu ngoxonecü rü chütacü tanadai?

Buxügu nüxü nixu i ngëma nüxü nacuaxgü.

Nguxëtaeruxü rü buxügümaxä oxi ya feneetaxena nacagü nangëürüxü i ngunexü naifenee.

Nguxëtaruxü rü poperaatü puracuruxümaxä tanue rü inachoxü nanoxrü papagümaxä nadexagü nachica i fenee.

Tawoegu nguepataüwa rü nüxü tadaumatü i ngëma toxrü ngäü rü popera taatüxügu tanaüxchicünaxägü i naëügu i ngexonecü i ü rü chütaxü i ü.

¿Texegü tuxü taru ngëëëgü?

Paparü mama rü naxäcügüü naümücü

Papa tuxna i cagüe nachiga i fenee.

¿Taxcü tanaxwexe?

¿Poperaatü naxchicünaxägümaxä ngächicünaxä, chiguchicünaxä, manexechicünaxä, nacüchicünaxä, ëxcuchicuxna rü towachicünaxä?

¿Texé tuxü tarüngüxë?

Papa rü mama nabuxügüxü tarü ngüxëgüxücax.

¿Taxcü tanaxwexe?

Naxchicünaxägümaxä ngächicünaxä, chiguchicünaxä, maicu, nacü, icü rü chenema.

Papagüna cagü taxü nañuxäcü nadaxü i naëügu rü naüxchicünaxä. Wüxi "x" ina ächicaüwa.





Chauega:.....

Ûcaxarü yütacax tanguxe

Nguexëteruü nagu i ü

Papana taxu natüxü tarünguëxücacax
nañuxäcü yüta i ü, rü tamaxä nüxü tixuücacax
nañuxäcü naü.

Buxügü nüxü narü daunü rü narü ññue,
ngëma papa nanguxë rü tüxü narü
ngüxëgü noxrü üwa.

Nguepataxüwa nüxna nacuaxächie i
ngëmaxü i namaxä yütanena ügüxü.

Buxügü namexëgü, nguxëtaeruxü rü
naixmenaxä naguxügüraüne nüxna tana rü
cagü taxü:

¿Ñuxäcü cunanu ya naixmenaxä yüta
maxä i üxüne?

Buxügü nüxü naügü naguüxäcü nanugüxä
ya yima naixgü.

Nüxü perü daunü rü meä penanu, taxüwa
penaügü rü ixraügu peaguxë.

Nanayaxugü i poperaatü puracüruxü,
naxchicünaxä ya naixäcügü ya naweama
ngëmagüne.

¿Texé tüxü tarüngüxë?

Papagü.

¿Ngextá tanaxü?

Nguepataxüwa rü xīātüwa.

¿Taxcü tanaxwexe?

Tomaëxpüx i naixäcügü inaguxügüraüne.

¿Texé tüxü tarü ngüxë? Papagü ¿Ngëxta tanaü? Nguépataüwa, ñchicüwa.

¿Taxcü tanawaxe?

Tomaëxpüxraüne ya naximex naguxügüraüne.



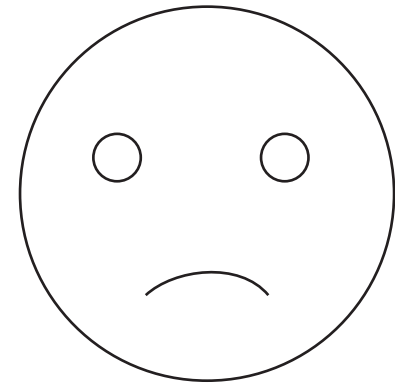
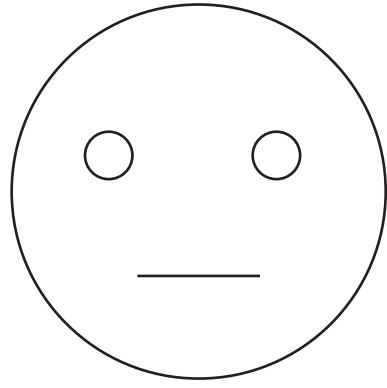
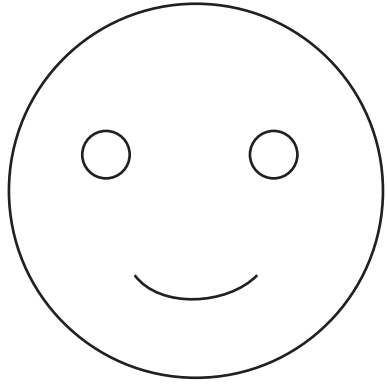

Chauega:

Baraderamaxã taĩnũcawaxegũ

Nguexẽteruũ nagu i ù

Nguexetaeruxũ nguẽpataxũwa tanange i maxgũtaeruxũ.

- Buxũgũrũ nũxũ niugũ nataxcũwa namexũ ¿taxcũwa naxũ?
¿ñuaxcũ naxũ? ¿texe tixĩ namaxã cuaxe? ¿ñuãxcũ namaxã? ¿tacuax?

Nguexẽtaruxũ buxũgũmaxã nawa naĩnũcawaegũ i maxgũtaeruxũ. Nũxma nacuaxãchiãxcũ nañuxãcũ namaxã i cuax. Ñuxmachi namaxã nanguxũgũxũ.

Buxũgũ nũxũ nixugũ, ngexgũma namaxã i maxgũtaexgu, nũxũ i cuaxũ nangextaxacũ i maxneta.

- ¿Tanangaxũ i ñuxre cagũ?

- ¿Ngextacũne tachi ngexguma i maxãneẽgu?

- ¿Texeũ tamaxũ?

Nguẽtaeruxũ nanaũmatũ i taatũxũ i poperagu buxũgũ nũxũ i uxhuxũ.

Tama tamũcũxũ tamaxmare.

Tama tũxũ tawamũxẽ.

Ngemawena ĩaxtũwa taxĩ, buxũgũ naĩxatũwa nanamaxgũ, ngẽma naĩxatũarũ yixĩ rũ ngexũgũ nananutaquexegũ.

Perũ inũe rũ nũxũ pedaumatũ i nguexẽtaeruxũ nũxũ i uxũ. Añaxcuchi i naxchicũnaxã. Naũxchicũnaxã i nachametũ taẽxũchi ngẽxguma cuanguxẽgu i mexũ nacũma.

1. Naĩxãtũ taũmatũgũ.

2. Ngẽma tama i naxwaeũ i maxneruxũ nũxrũguama tananu.



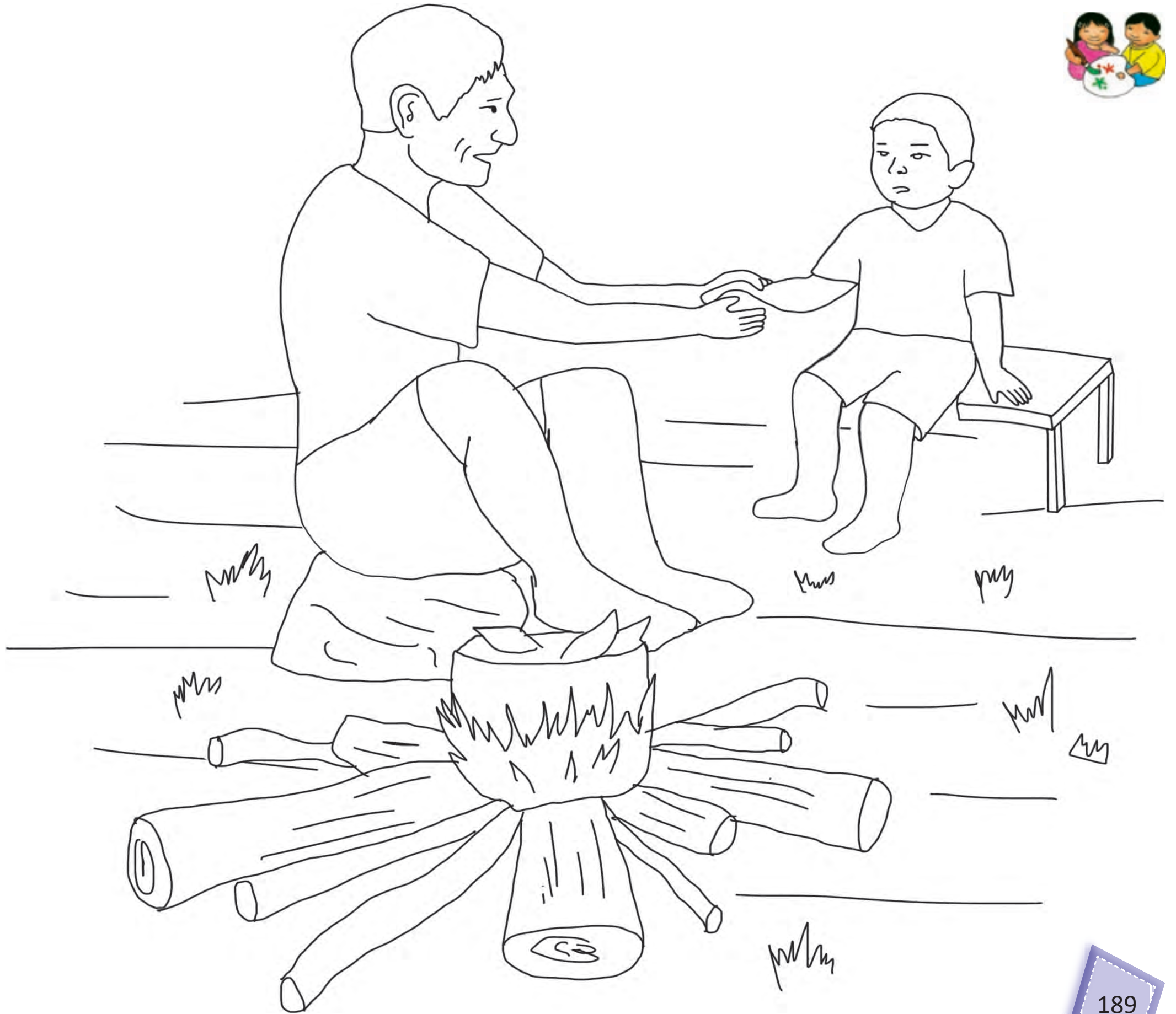

Chauega:

Yigü taüxüchacüxü i mexchinüxücax ega i feneegu

Nguexëteruü nagu i ü

Nguxëtaeruxü tanawex i naxchicünaxã, naixchi, cuare, ngúxchi.

Buxügü rü nachiga nidexagü i naëxügü rü werigü ega marü namaxã a äüxnagügu.

Tümaüxtawa taxí ya noxë nüxü cuaxe nachiga natamaxã nüxü tiuxüca.

¿Taxcüruü i ticünagüarü buxügü namaxã nügü naüxügü?

Nguepataüwa buxügü nachiga nidexagü i noxë namaxã nüxü i uxü.

¿Texé tüxü tarüngüxë?

para rü buxügü.

¿Ngextá tanaxü?

Nguepataüwá.

¿Taxcü tanaxwexe?

Namí rü üxü.

Nüxü nadawenü mexã i naxchicünaxã, nawa nadacunüxë, ngexta buxü itaüxü ya noxë.





Chauega:

Naeügarü peta

Nguexëteruü nagu i ü

Wuxí nguneugüga ngobu rü nii nguarü dauneciãx rii napetaerü nguüüma gü naëüna nau.

Wiyagüü nixí guxüma ga maiëcha rii nuxmachi puxeru tüxü na paxgü noxrü wõxnecüruü rü naichaxmü naxcax nixí, noxrü wacharaca rü tuxchinaxcanixi.

Maiechagü nü nawiyaegu ga ngobü rü iniñaâchiü.

Ngobüwe rü guxüma naëü iniüâchiü cowü wexu towa ngaixre rü cura, wuxichigü noxrü tama yuxümaxa niiuchi. Yexguma rü yema na ngox ga aiga tama ngobü nüxna u rü yema naagux ga peta...

Nguepataxüwa buxügü nachiga nidexagü i noxë namaxã nüxü i uxü.

Ngueëtaeruü rü nüxü tadaumatü i nachiga i u, rü ñuxmachi cataxü.

- ¿Taxcüü i naëögü yixüügü?
- ¿Ngueëtaeruü rü nüxnatanaã i poperaatu i puracüü?

Ngeta nangemaxü i nachiga naëügü rü nuxmachi nüxü tadumatü wuxigu buxügümaxã.

Aguegu nüxnaxca buxügü nañuxãcü agueü i nachiga naëüarü petachiga rü nuxmachi pena üxchicuna i poperaatugu.

¿Texe tüxü tarüngüxë?

Nguexëteruxü.

¿Taxcü tanaxwae?

Naeüchinaxãgü.

İañaxcuchi i naxchicüxna nuxmachi na üxchicüxna na nuxâcüa gü cumücügümaxã nüxü i u nachiga i naëü arü petachiga.





Ngobü

Three horizontal dashed blue lines for handwriting practice, located below the word 'Ngobü'.



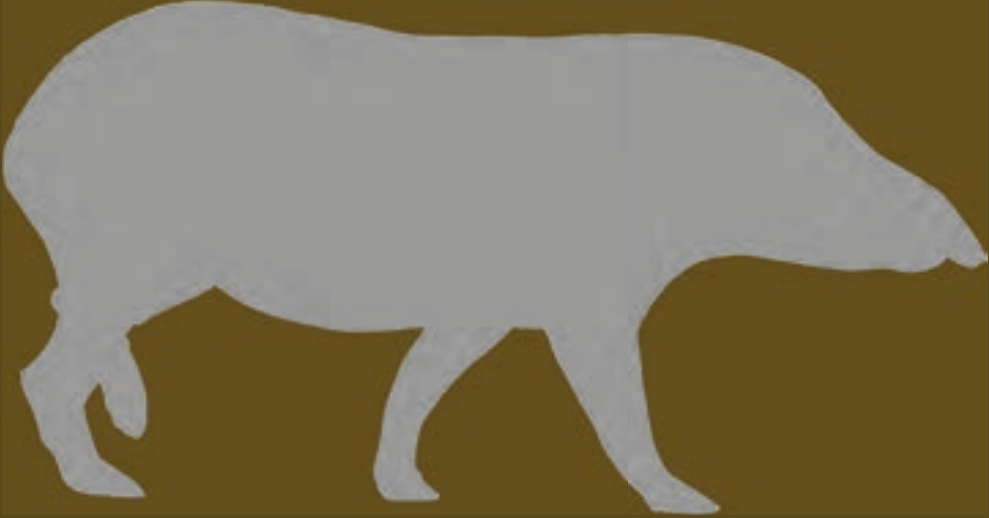

Nacü



Öme



Ngã



Ïxcü



Yoca



Powi



Duxri



Chenema



Cowa



Ngoxü



Chauega:.....

Nachiga tidexagü i nguxüma puracugü

Nuxacü ta puracü:

- Taboxchimüxügü nangēmaacü yigümaxā i inücaxwēgüxücax.
- Nguxüma i puracü i tawemücü i tupanachiga.
- Nguexētaruxüarü guexēmaxā rü tanangāxü i cagü.
- ¿Taxcüarü puracü taxü i tupanachigugu?
- ¿Texe tüxü tarü ngüxēe?
- ¿Ngexta netaxī?
- ¿Toxrü popera i puracürüxüwa?

Tanaxü i puracü i ngēma puracürüxüwa nüxü a ú.

Ngucüma i puracü i tupanachigagu i üx rü nüxna nacuaxāchi nataxcü cuxü. Tapuracüe ngéchaxüäcü, tanaüxchicünaxā rü tanachauxgü ngema tüxü guchaüxü.



Three horizontal dashed lines for writing.

Tomagü rü tangechũwexgü rü tanguxēgü i mugü





Ñaã rü wüximexepüxarü taunecüxãgüxüarü nixĩ

Wüxi i ngunexũ	Taxre ngunexũ	Tomaexpü i ngunexũ	Ãgümücü i ngunexũ	Wüximexepüx i ngunexũ

Ngēxma nawü i ngēma ngunexũ nagu cuyauxmexũ.



Three horizontal dashed lines for writing, positioned to the right of the girl's illustration.



Wüxigunanu rü namexeãne i nguepataũwá.



Wüxi i ngunexũ	Taxre i ngunexũ	Tomaexpü i ngunexũ	Ãgümücü i ngunexũ	Wüximexepüx i ngunexũ
Wüxi i ngunexũ	Taxre i ngunexũ	Tomaexpü i ngunexũ	Ãgümücü i ngunexũ	Wüximexepüx i ngunexũ

Daag:

Ianācuchi üaxcüchicünaxā ngunexũ nagu cunaxü nacuxũ namexēane
wüxigu cuna nuxũ inguepataüwá i ngēmaxũgü.





Chaumücügü_ maxã cha inücawexe

Wüxi i ngunexũ	Taxre i ngunexũ	Tomaexpü i ngunexũ	Ägümücü i ngunexũ	Wüximexepüx i ngunexũ

Na üxchicünaxā wüxi nachametüācū i cagü ngēma ngunexũ nagu.





Mea tümamaxã chixĩ ya chaumücügü

Wüxi i ngunexũ	Taxre i ngunexũ	Tomaexpü i ngunexũ	Ãgümücü i ngunexũ	Wüximexepüx i ngunexũ

Nachaxu ngēma wūxigu ngēma ngunexü nagu mawá
cumücügūmaxā cuāmücü.



Three horizontal dashed lines for writing practice, positioned to the right of the girl's illustration.

Choxrũ mamachiga cumaxãchiu



Daxetixĩ ya chauenegũ

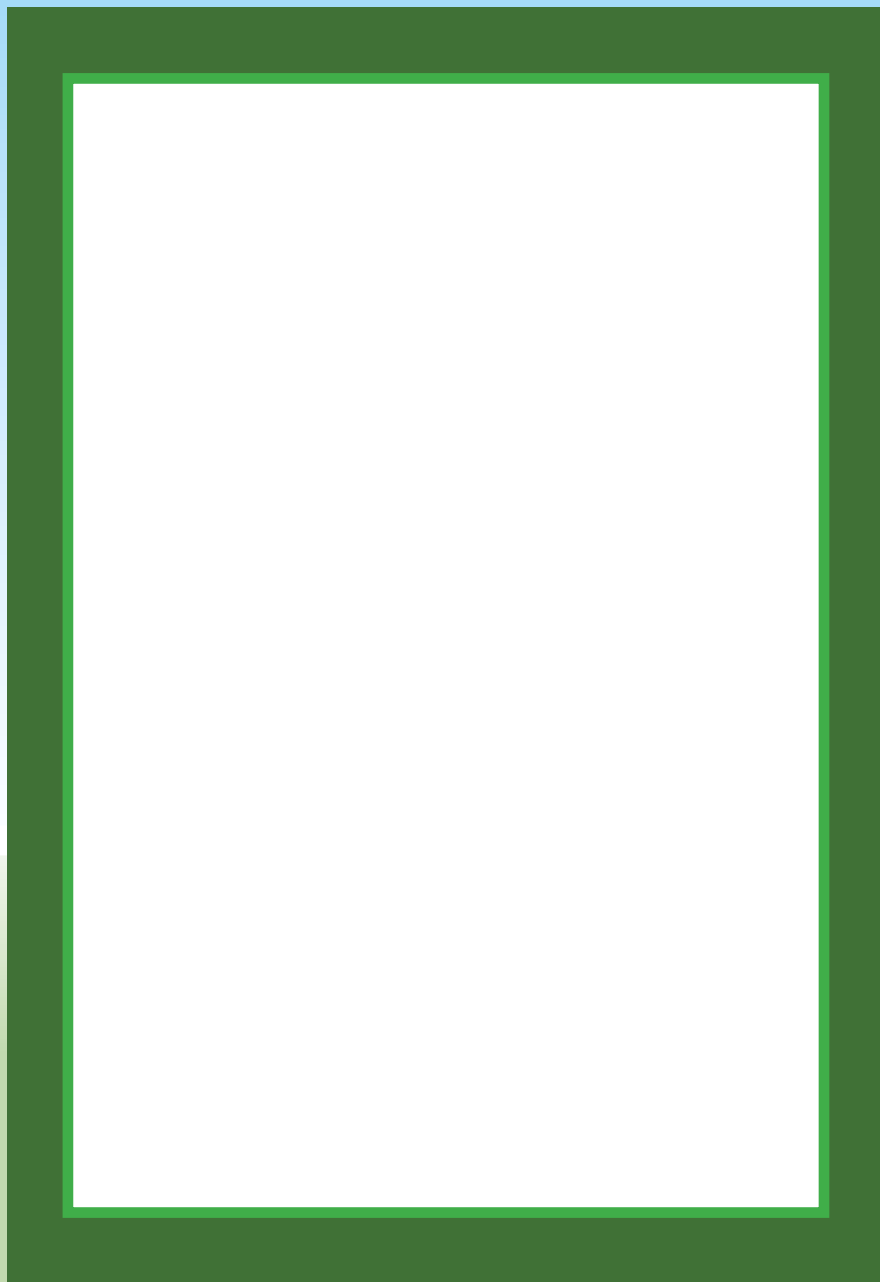

Daxetixĩ a choxrũ mamá

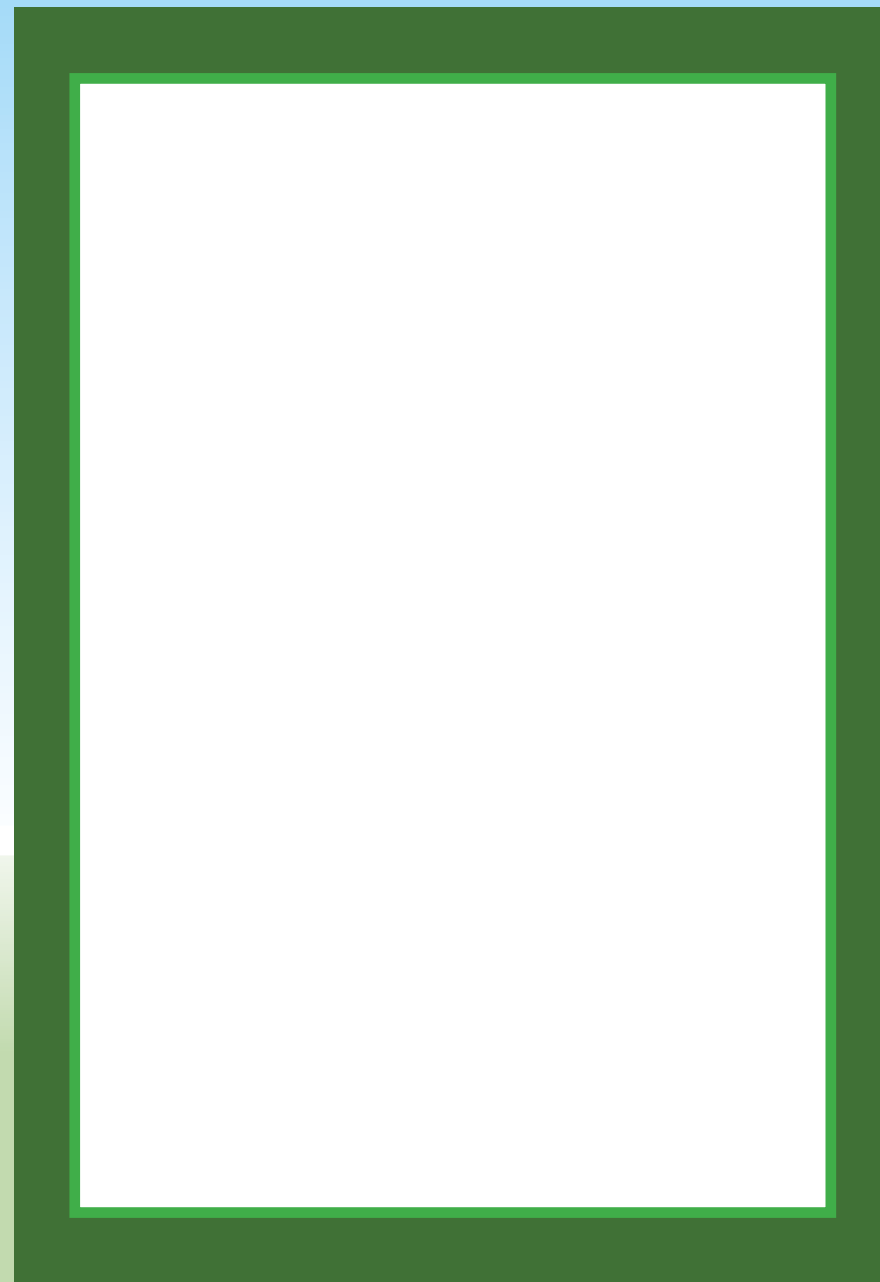

Daxetixĩ a choxrũ papá



Ngẽma choxũ
mexũ
nachanangõx



*Ngẽma tama choxũ
mexũ nachanangõx*

Changechaũxũchi Ñuxgu

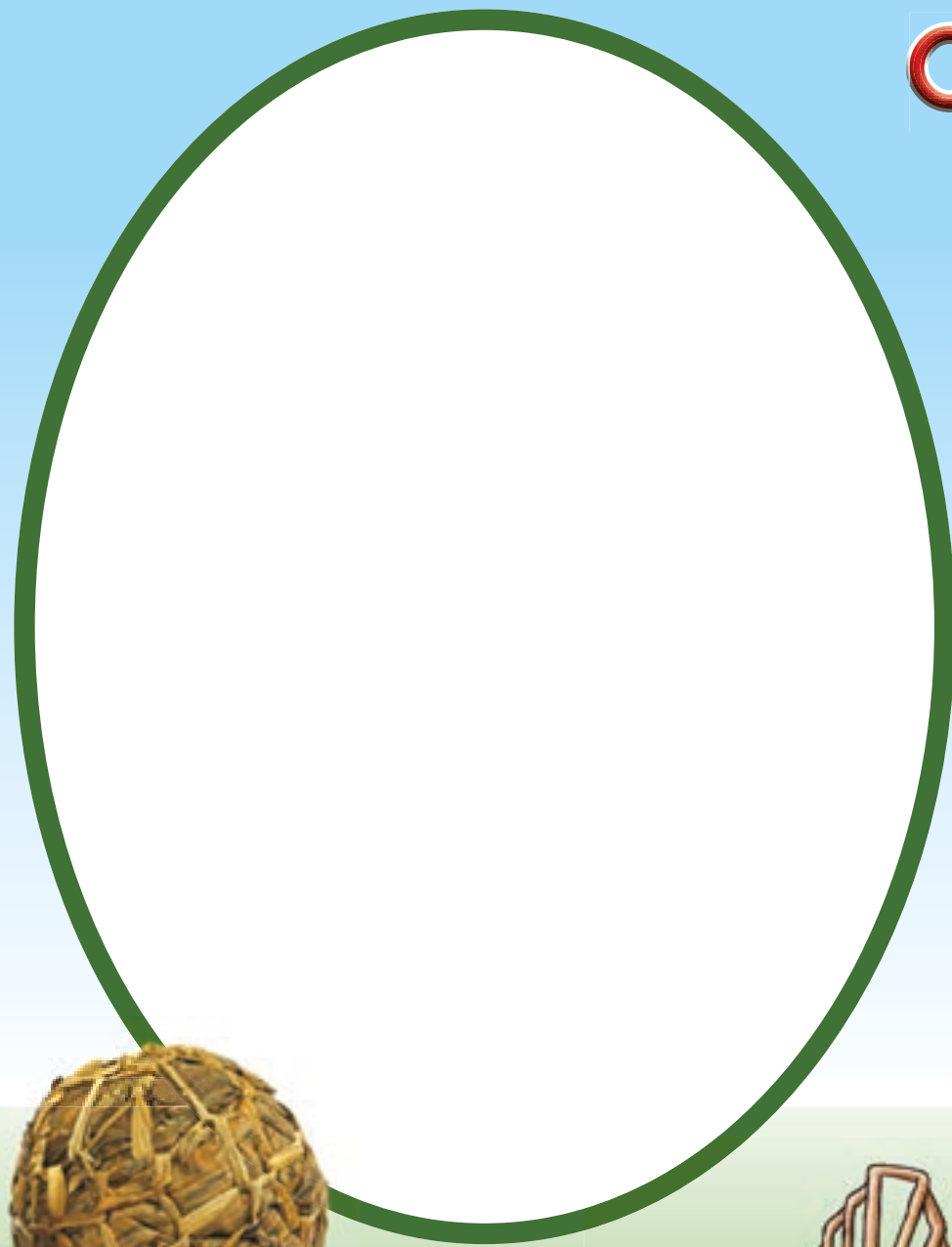

Chataaxẽũchi ñuxgu

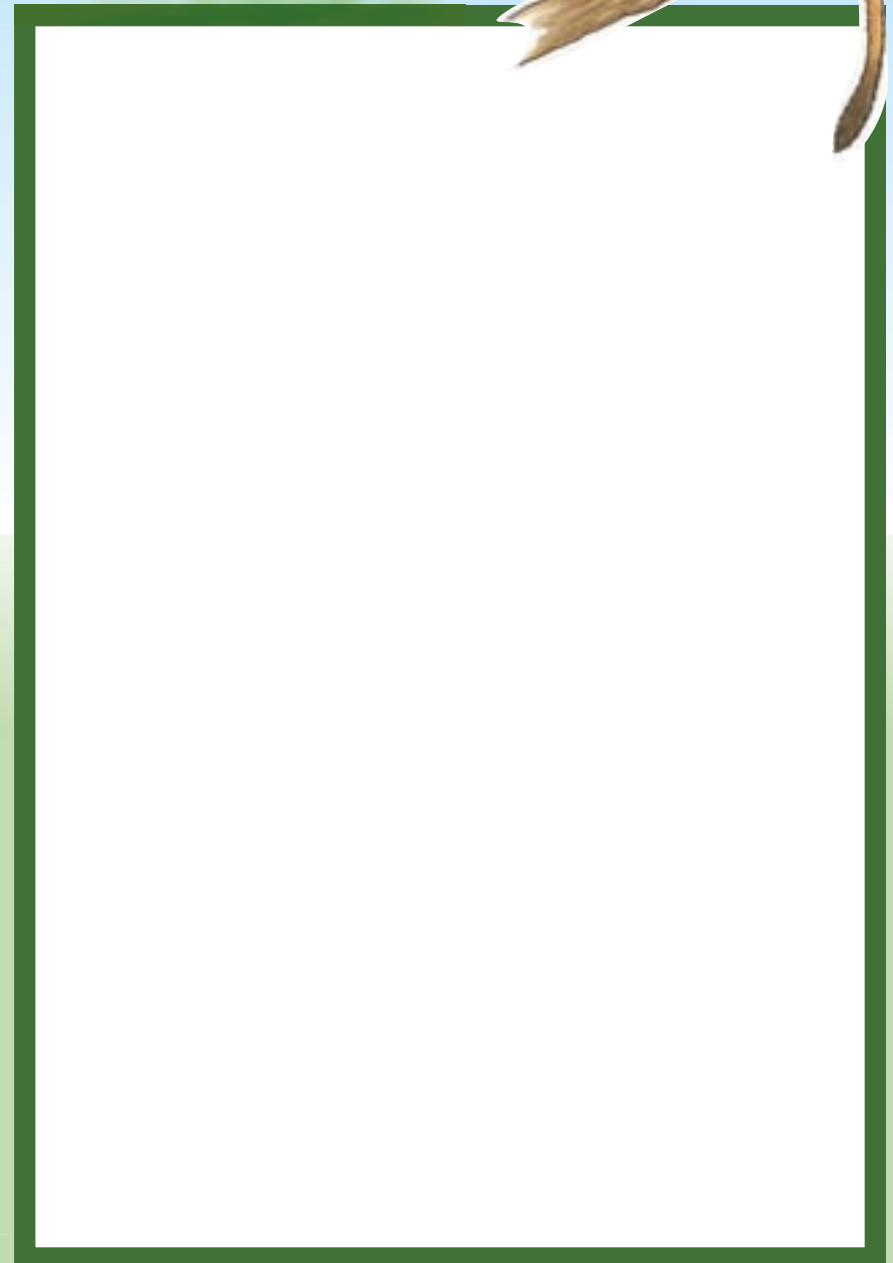

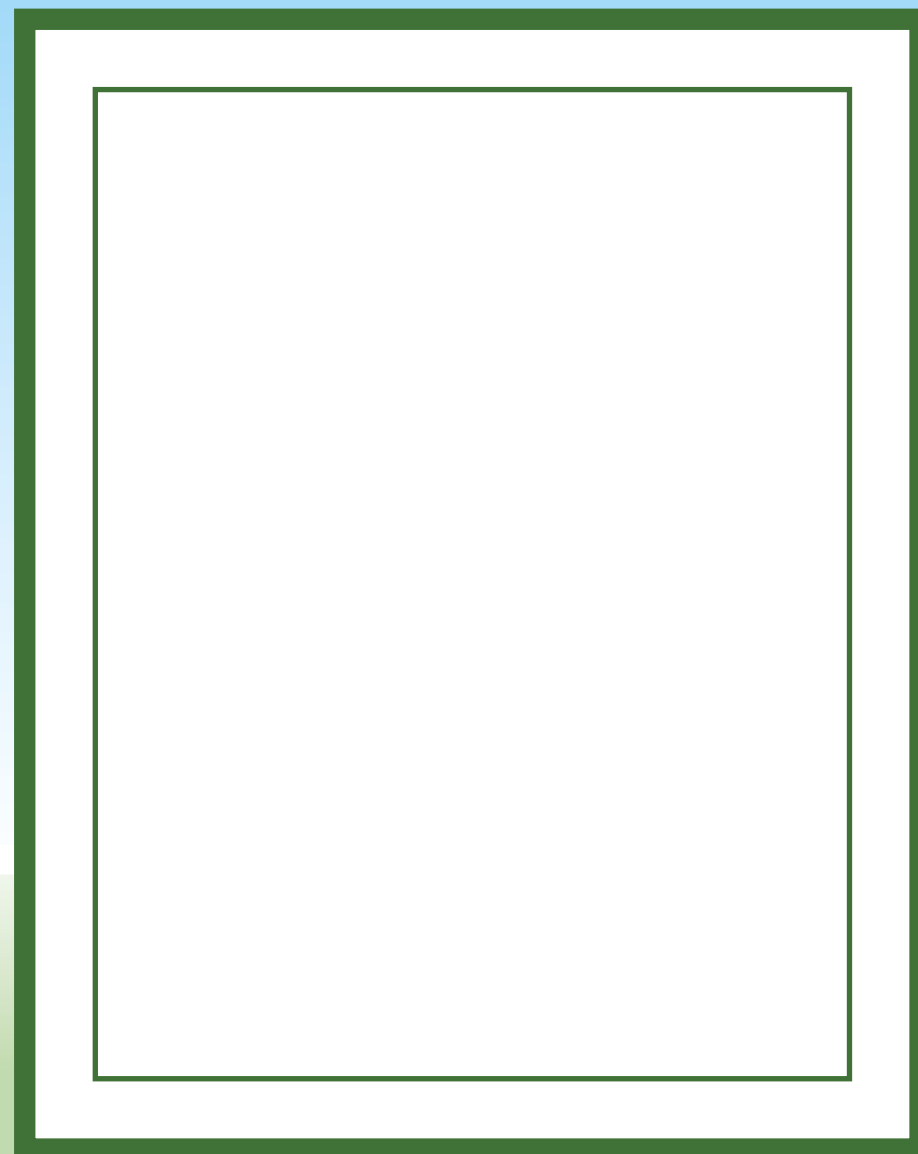
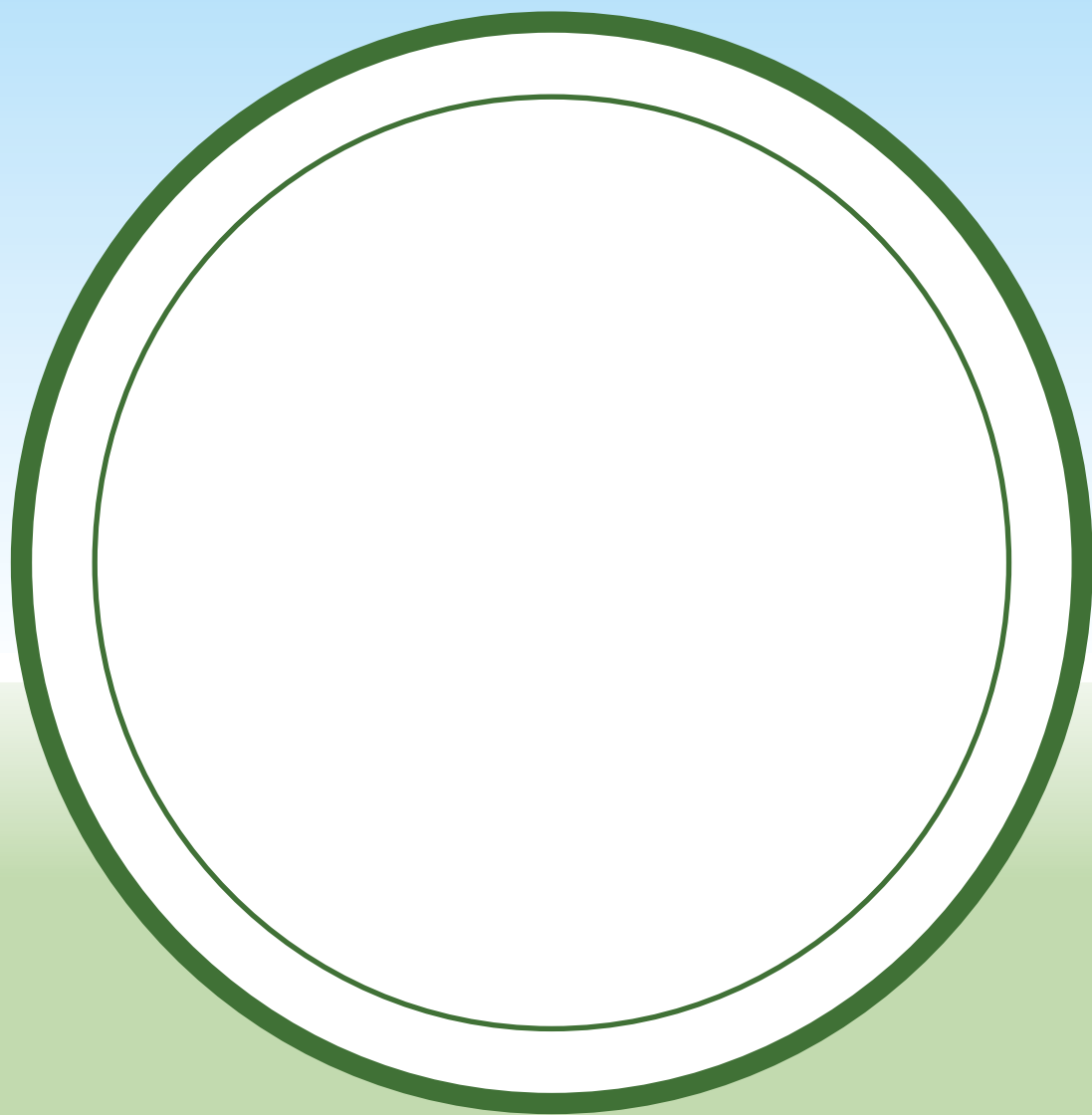

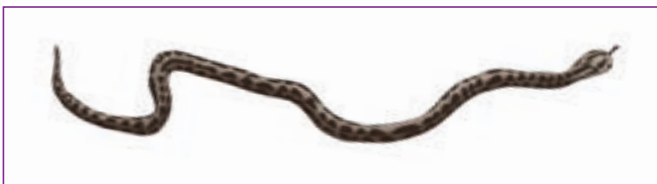

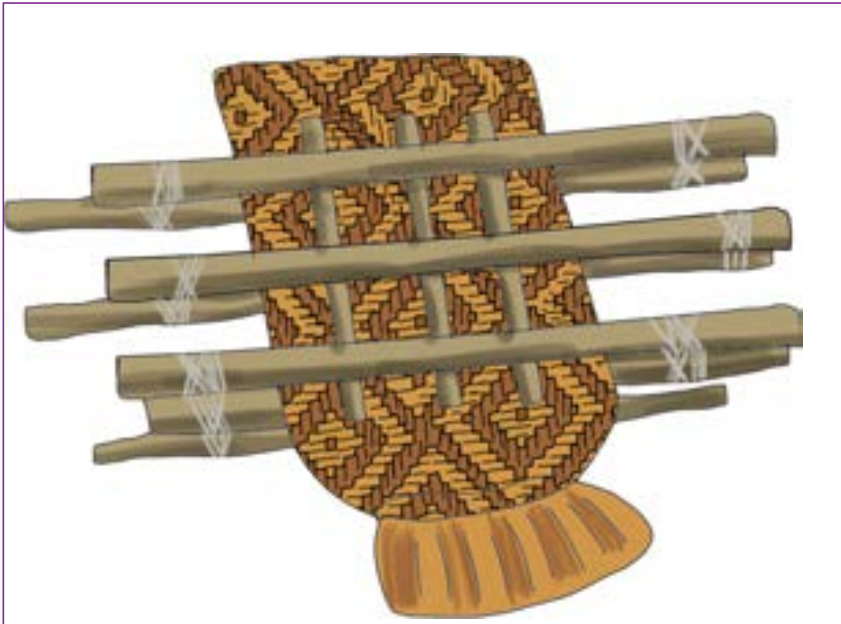







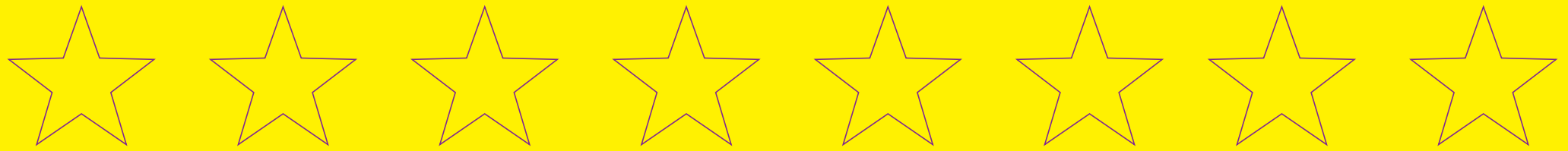
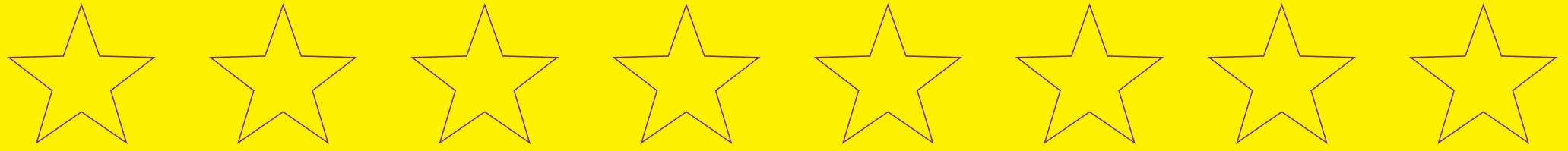
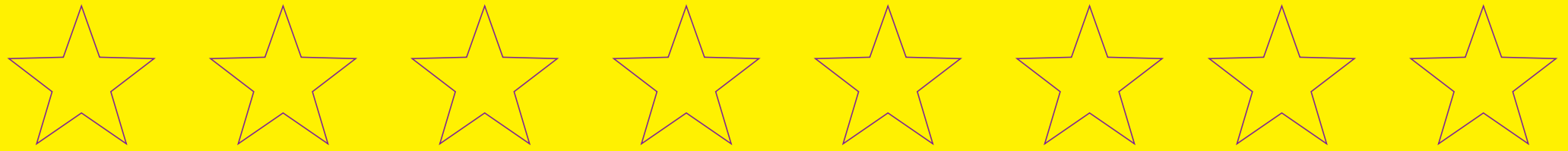





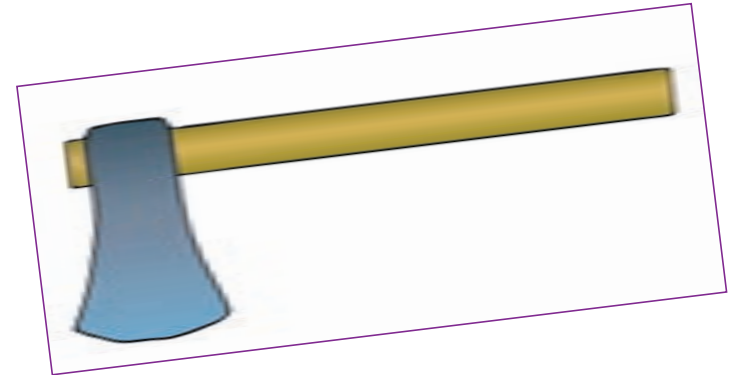

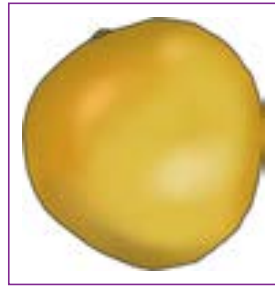

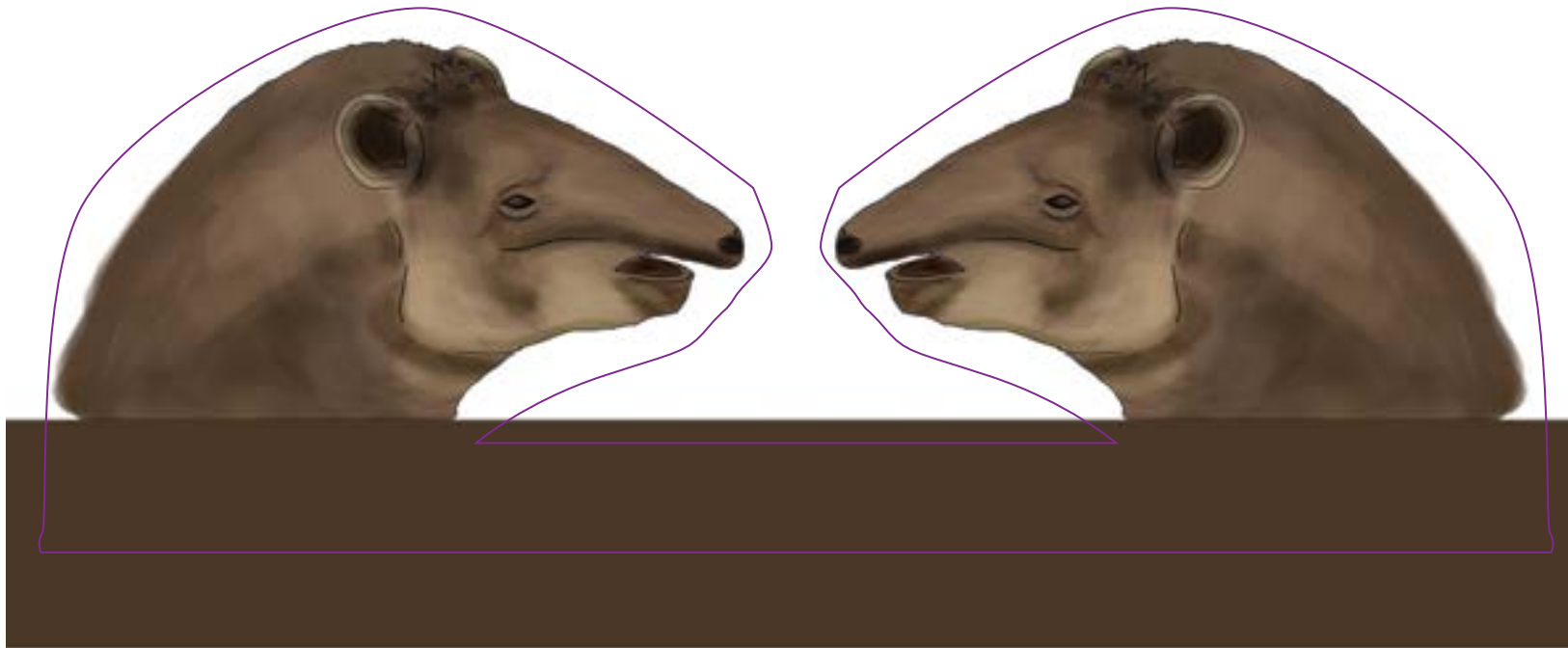



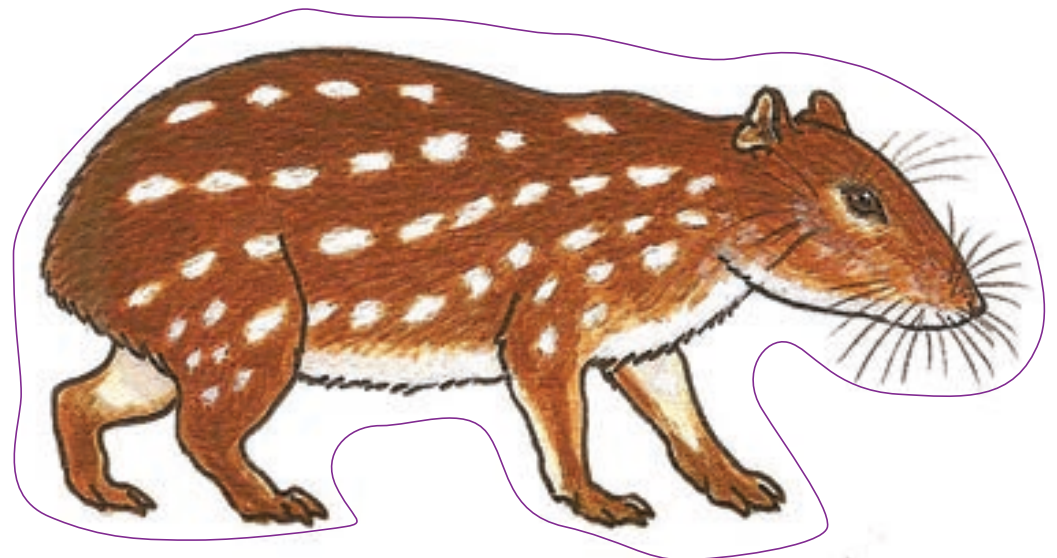
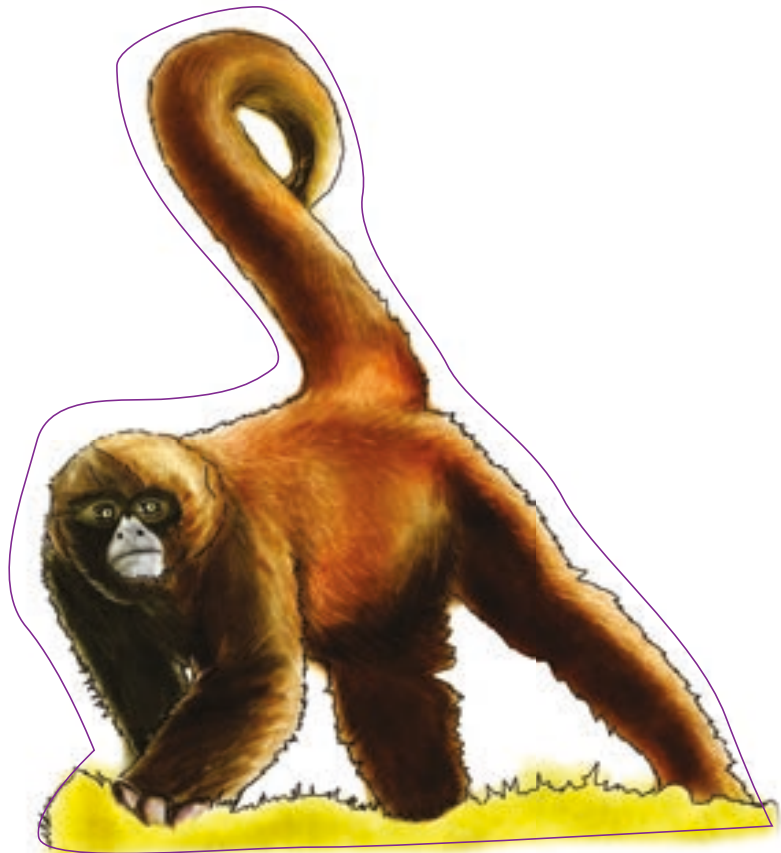
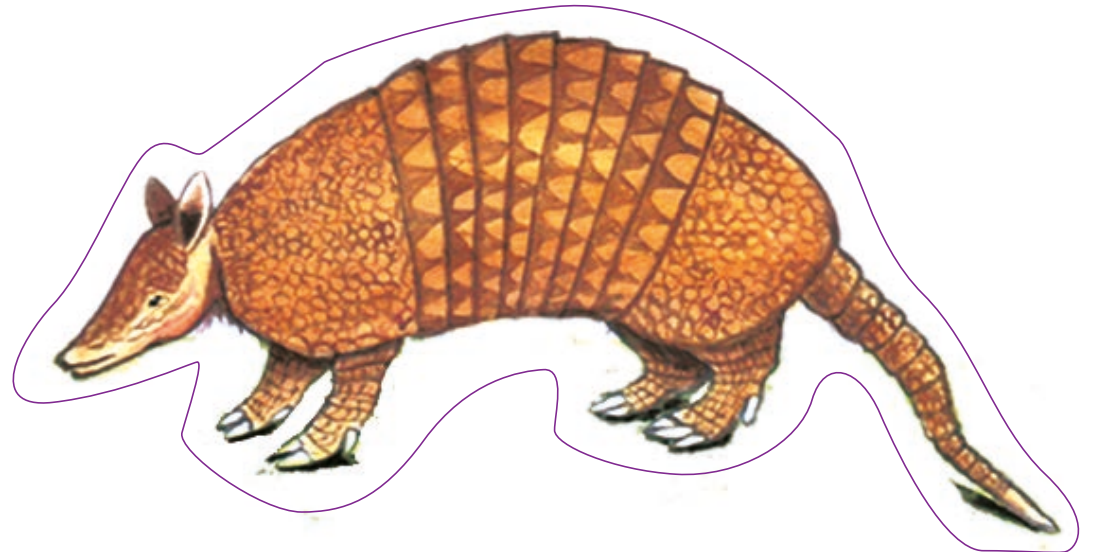
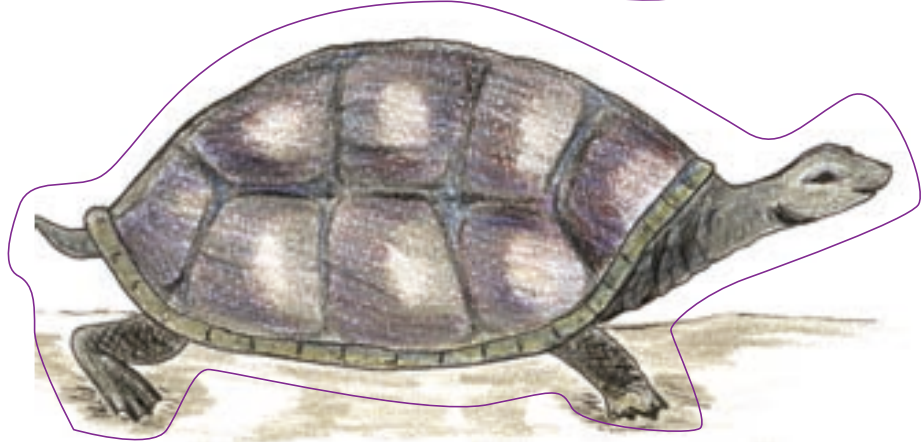
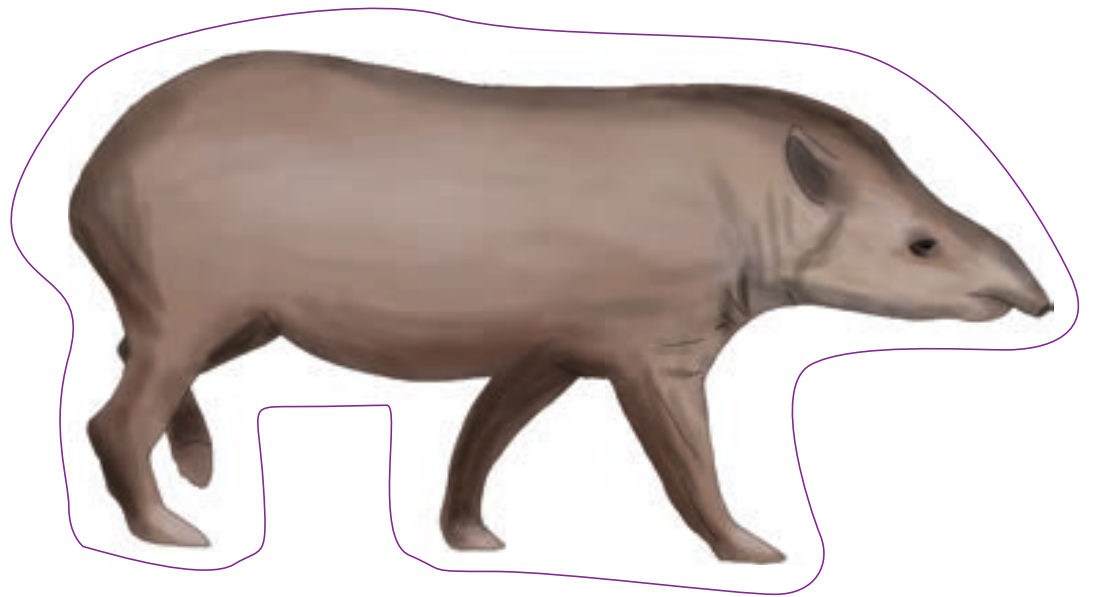
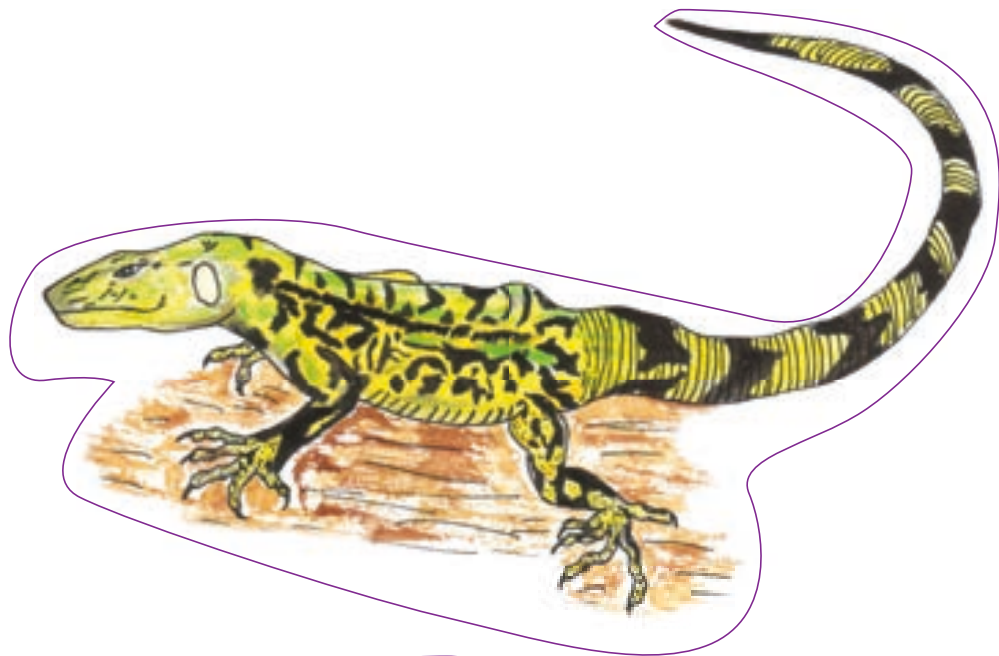

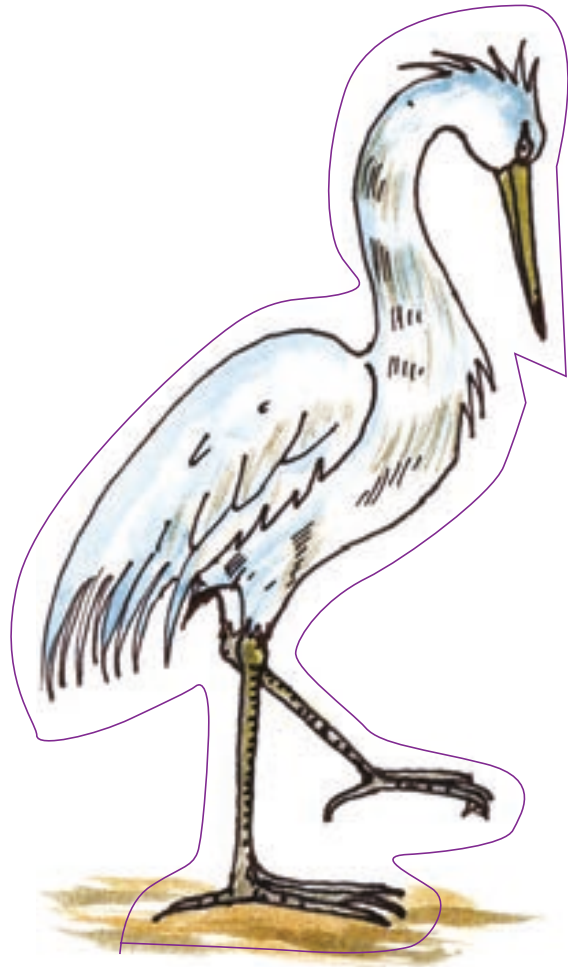
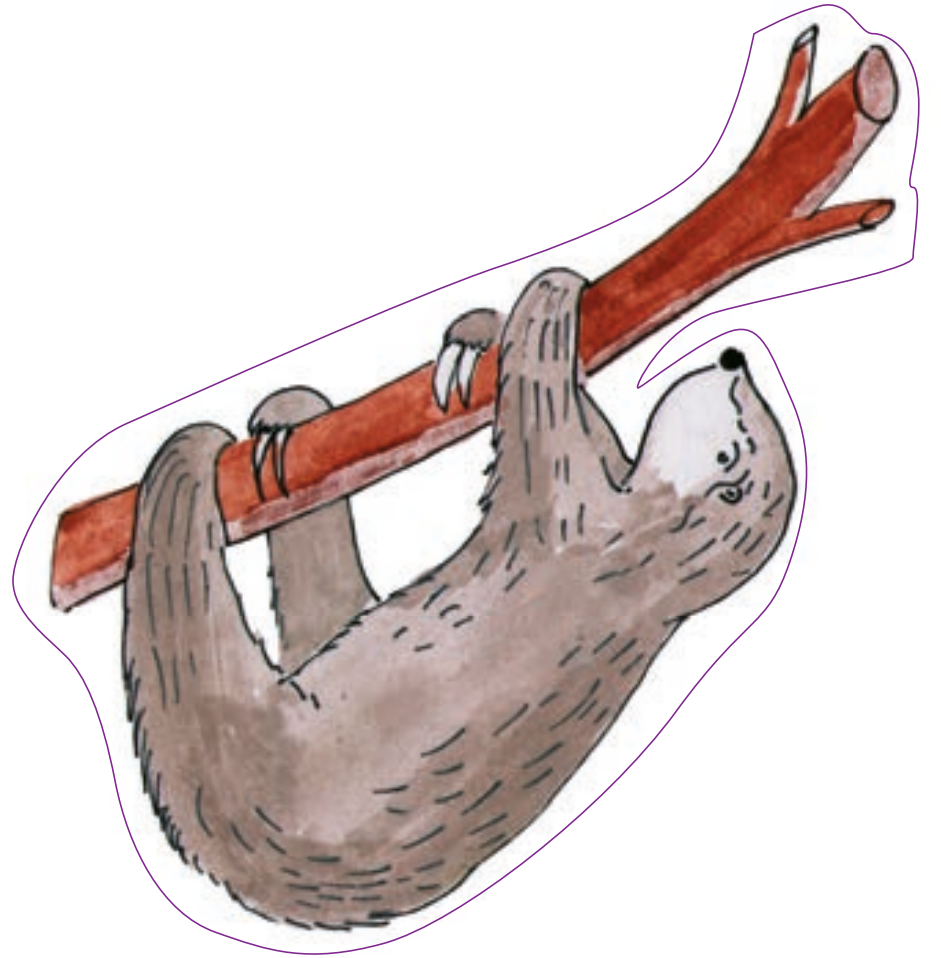

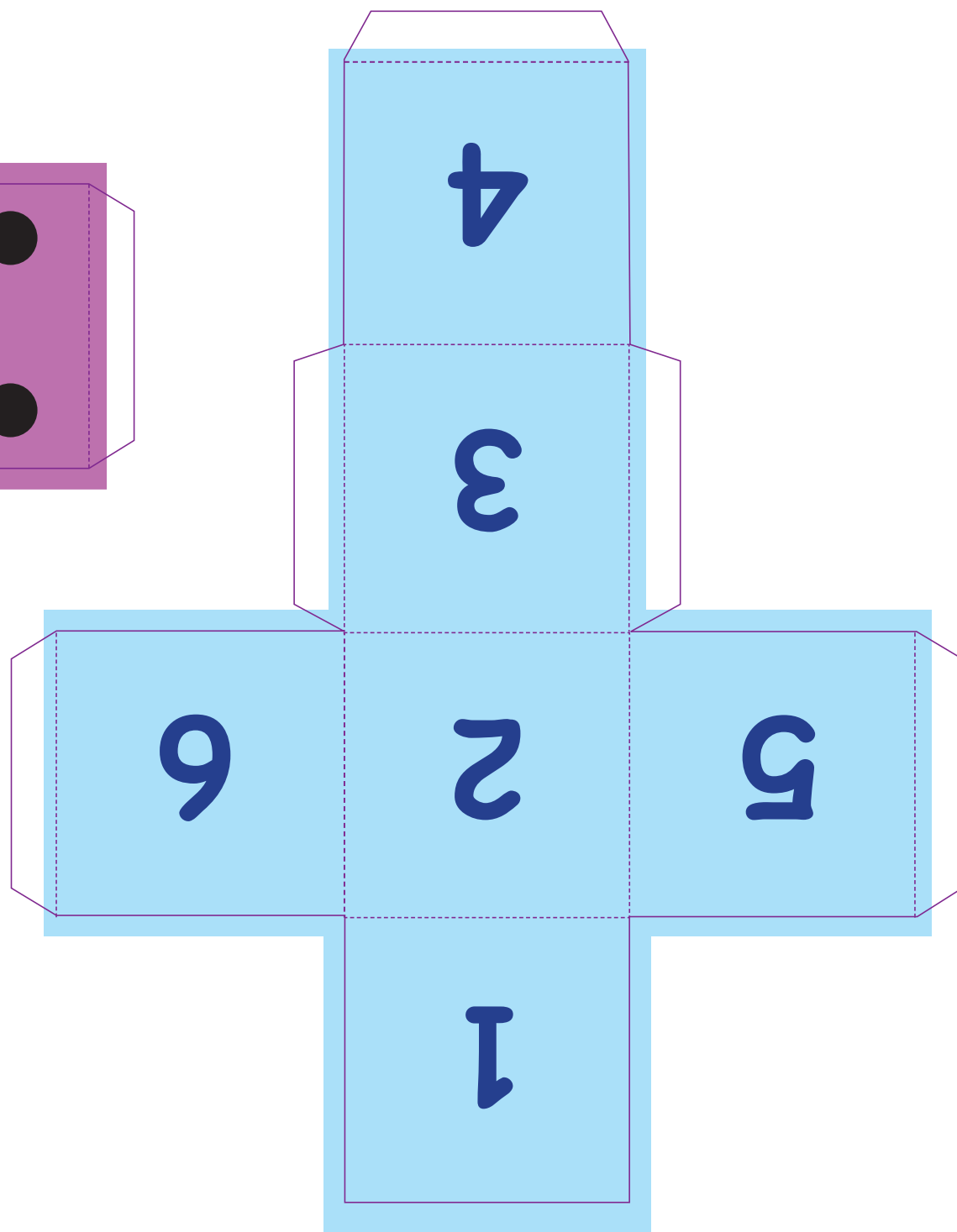
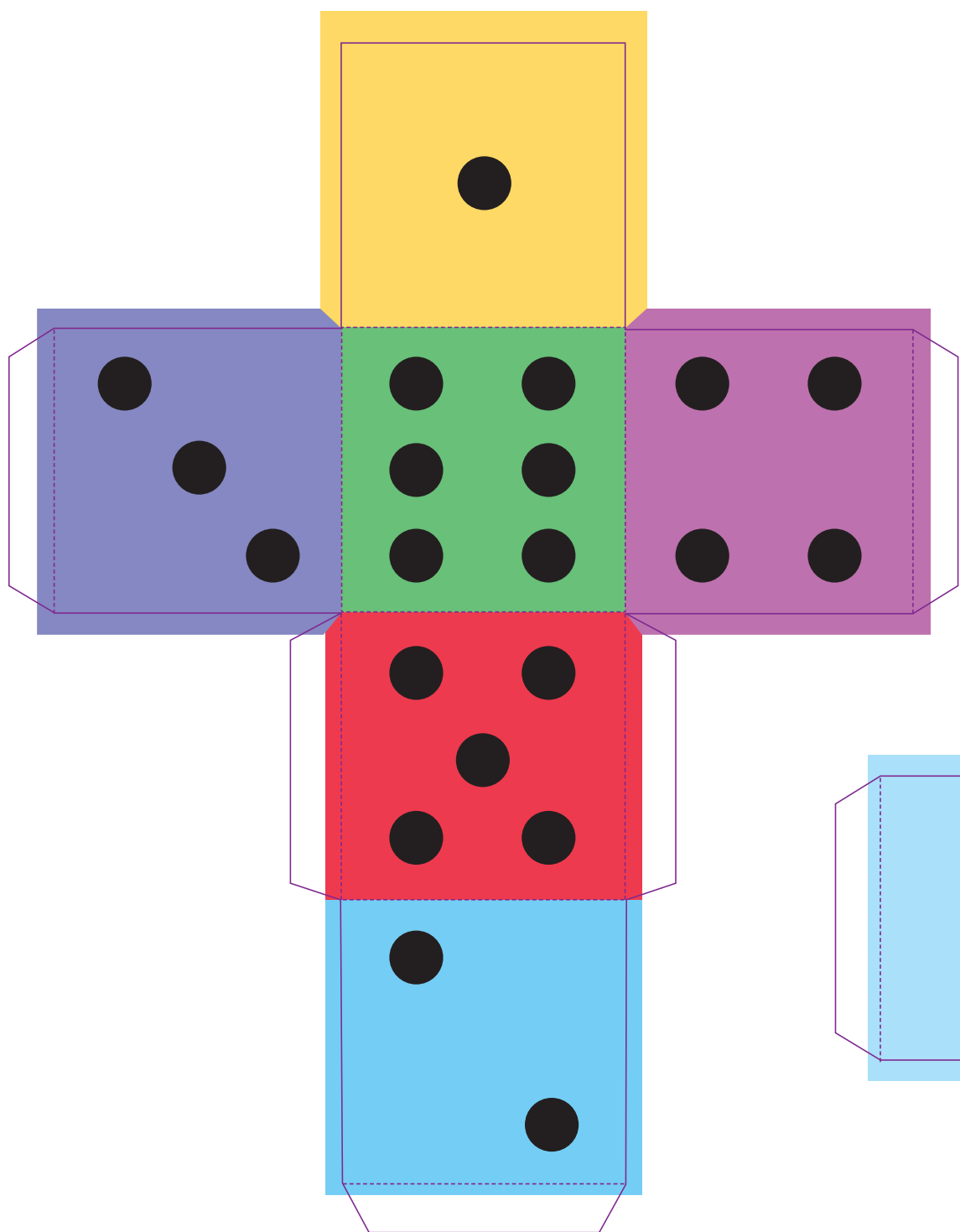

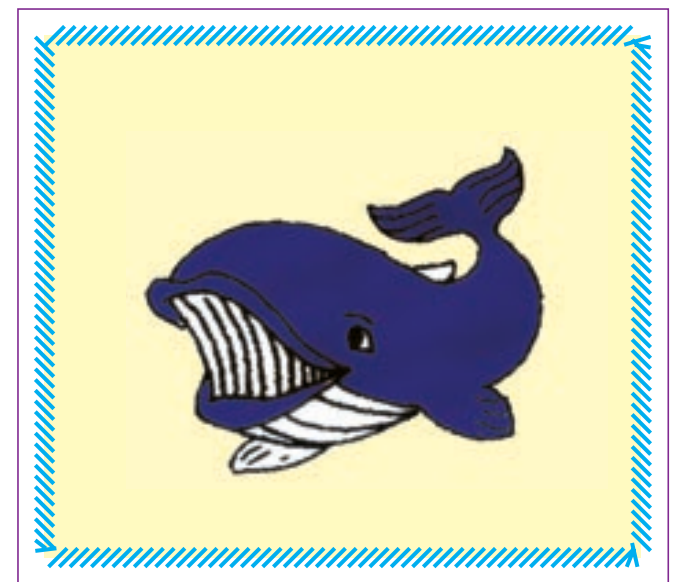
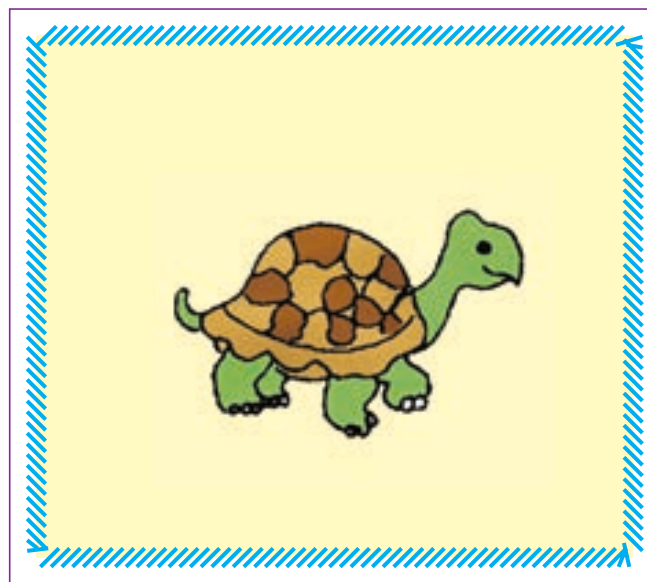
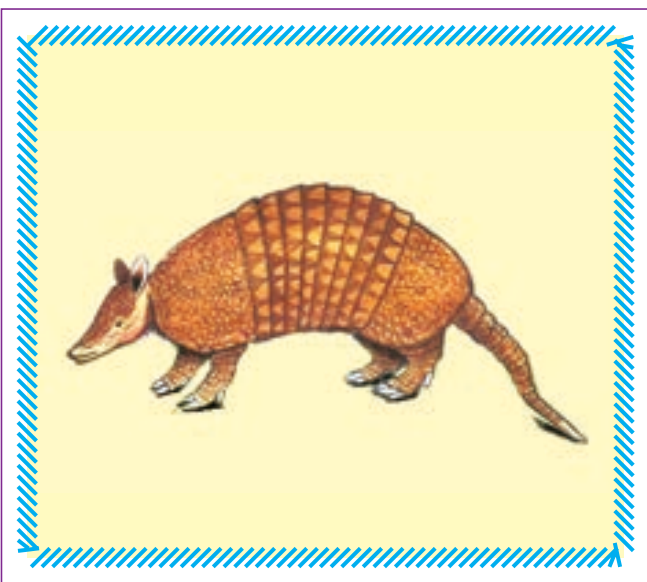
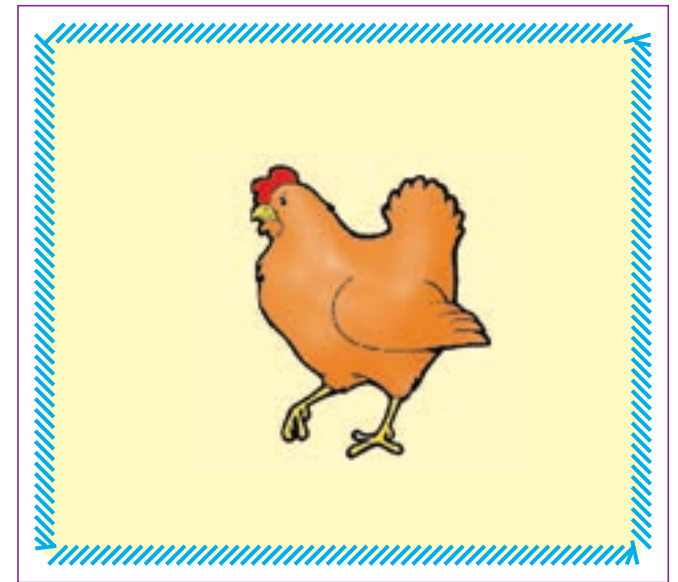
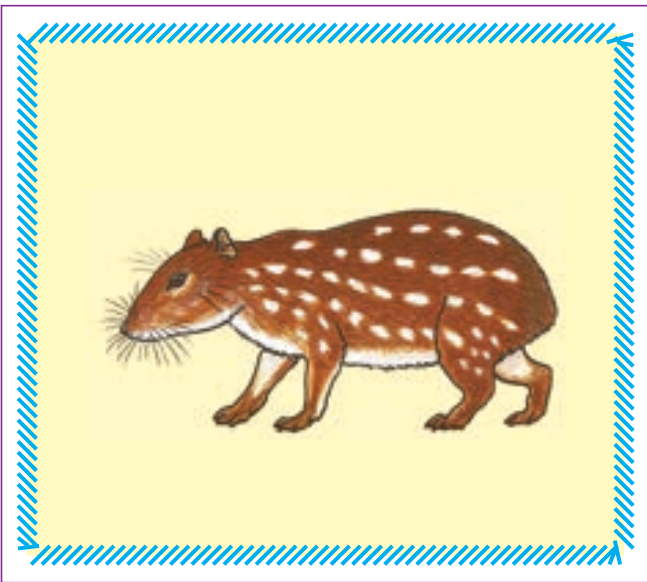
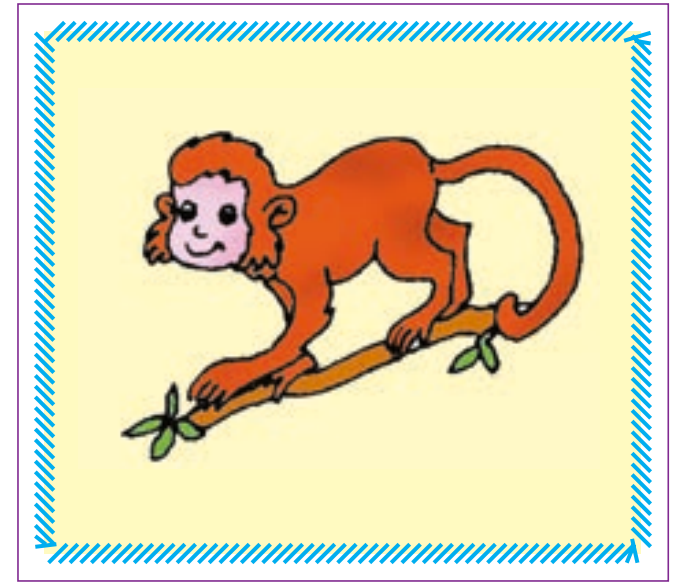

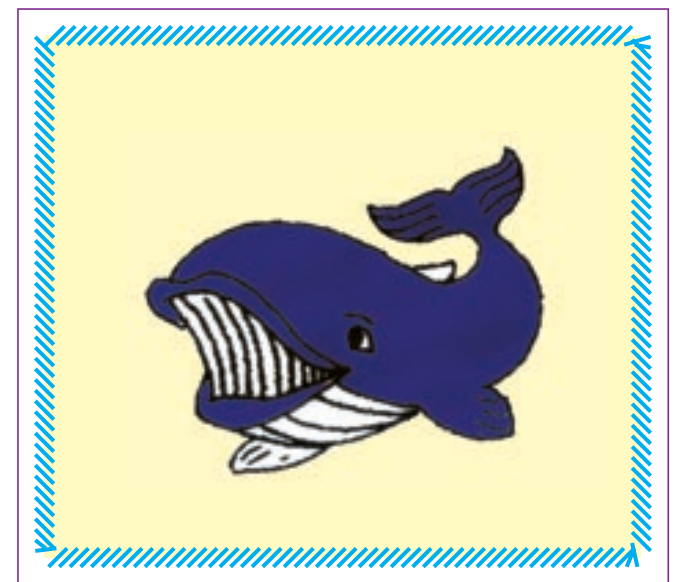
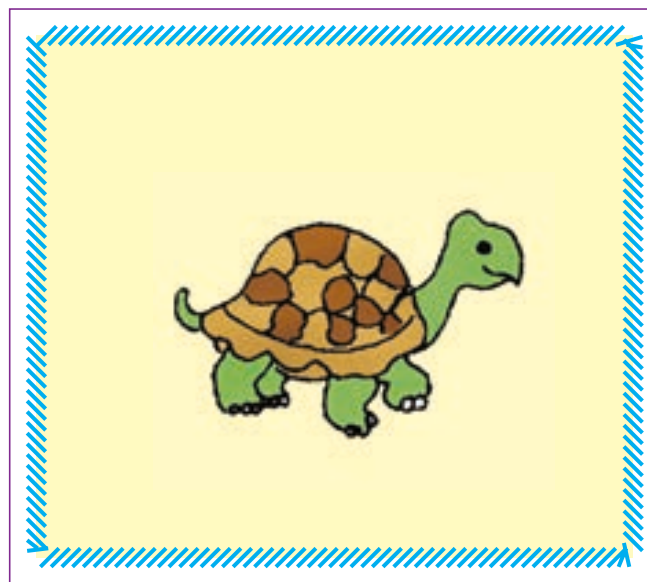
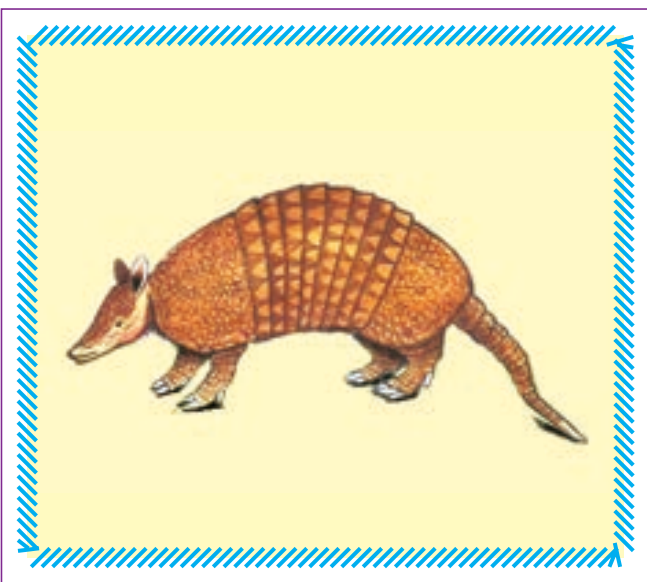
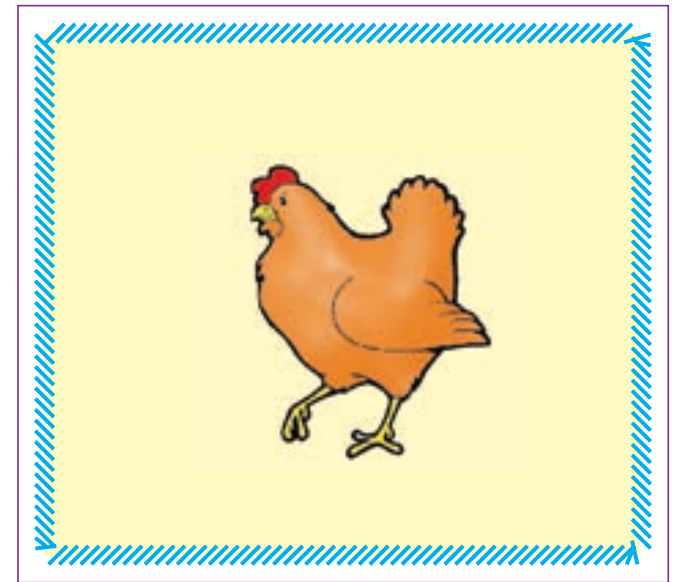
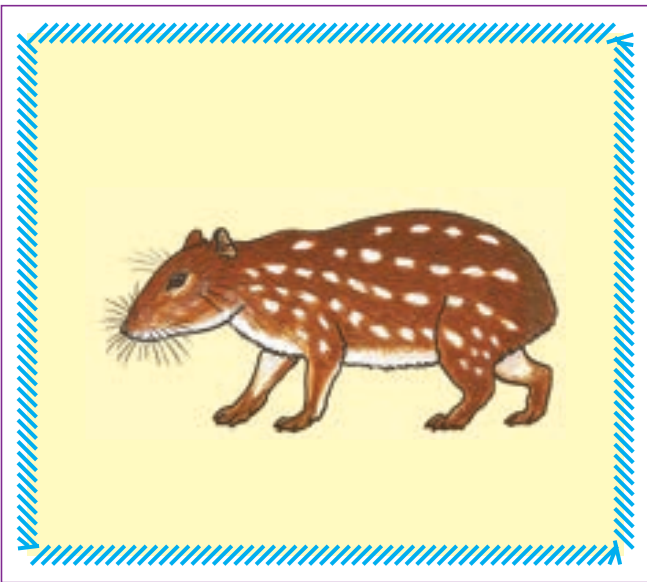
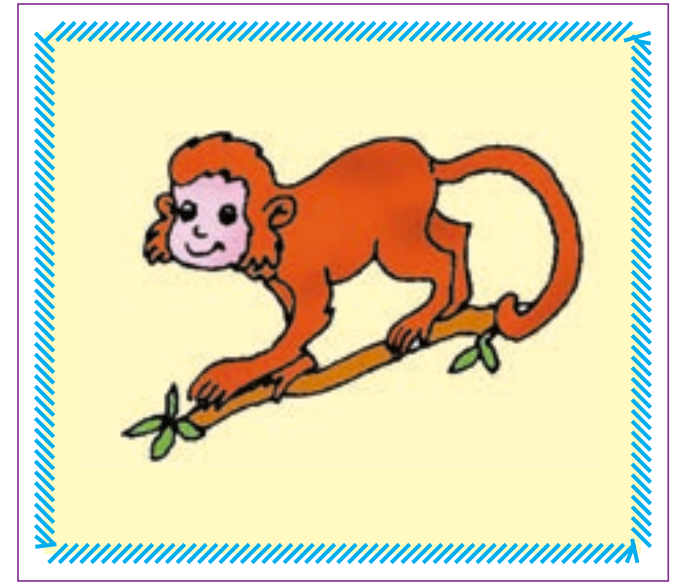

1

2

3

4

5

6

7

8

9



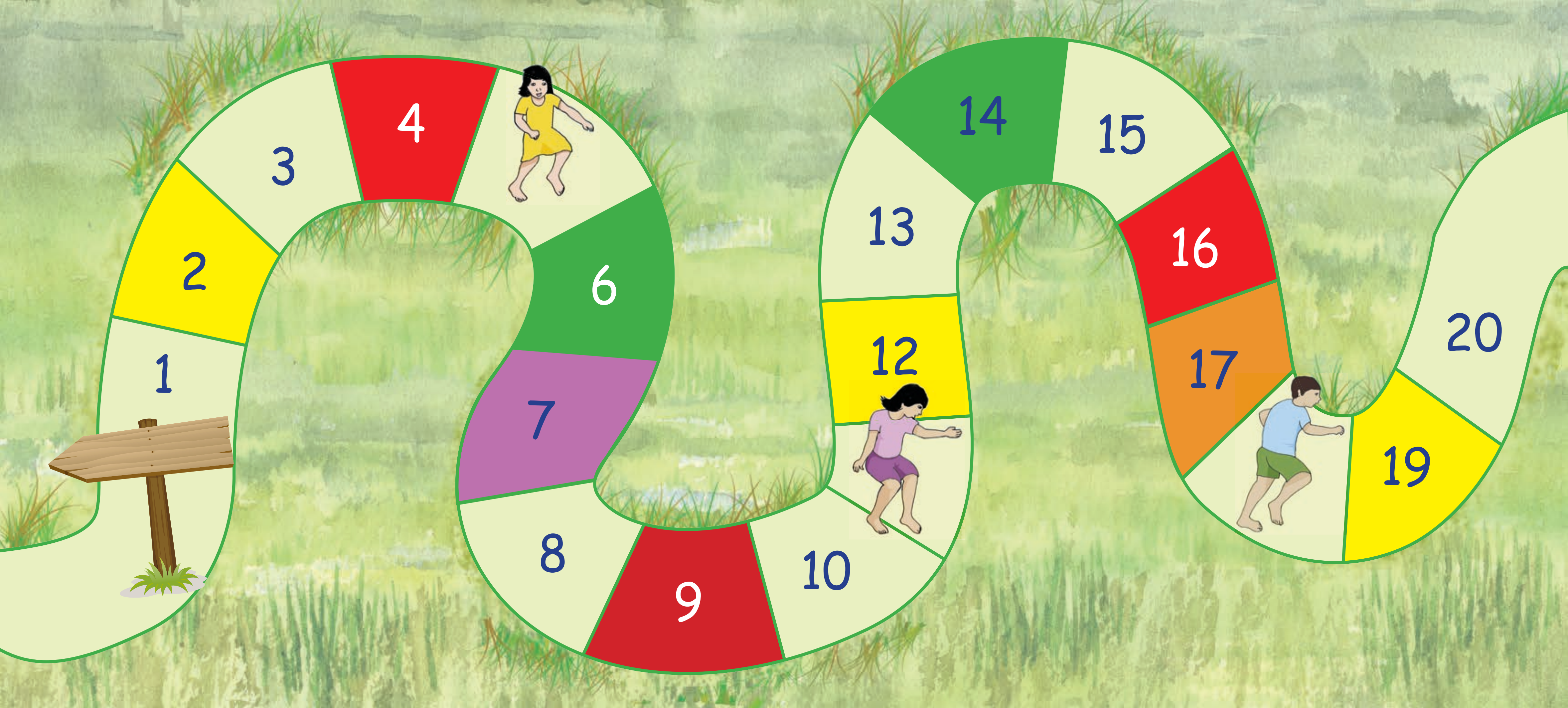

1

2

3

4



6

7

8

9

10



12

13

14

15

16

17



19

20



El Acuerdo Nacional

El 22 de julio de 2002, los representantes de las organizaciones políticas, religiosas, del Gobierno y de la sociedad civil firmaron el compromiso de trabajar, todos, para conseguir el bienestar y desarrollo del país. Este compromiso es el Acuerdo Nacional.

El Acuerdo persigue cuatro objetivos fundamentales. Para alcanzarlos, todos los peruanos de buena voluntad tenemos, desde el lugar que ocupemos o el rol que desempeñemos, el deber y la responsabilidad de decidir, ejecutar, vigilar o defender los compromisos asumidos. Estos son tan importantes que serán respetados como políticas permanentes para el futuro.

Por esta razón, como niños, niñas, adolescentes o adultos, ya sea como estudiantes o trabajadores, debemos promover y fortalecer acciones que garanticen el cumplimiento de esos cuatro objetivos que son los siguientes:

1. Democracia y Estado de Derecho

La justicia, la paz y el desarrollo que necesitamos los peruanos sólo se pueden dar si conseguimos una verdadera democracia. El compromiso del Acuerdo Nacional es garantizar una sociedad en la que los derechos son respetados y los ciudadanos viven seguros y expresan con libertad sus opiniones a partir del diálogo abierto y enriquecedor; decidiendo lo mejor para el país.

2. Equidad y Justicia Social

Para poder construir nuestra democracia, es necesario que cada una de las personas que

conformamos esta sociedad, nos sintamos parte de ella. Con este fin, el Acuerdo promoverá el acceso a las oportunidades económicas, sociales, culturales y políticas. Todos los peruanos tenemos derecho a un empleo digno, a una educación de calidad, a una salud integral, a un lugar para vivir. Así, alcanzaremos el desarrollo pleno.

3. Competitividad del País

Para afianzar la economía, el Acuerdo se compromete a fomentar el espíritu de competitividad en las empresas, es decir, mejorar la calidad de los productos y servicios, asegurar el acceso a la formalización de las pequeñas empresas y sumar esfuerzos para fomentar la colocación de nuestros productos en los mercados internacionales.

4. Estado Eficiente, Transparente y Descentralizado

Es de vital importancia que el Estado cumpla con sus obligaciones de manera eficiente y transparente para ponerse al servicio de todos los peruanos. El Acuerdo se compromete a modernizar la administración pública, desarrollar instrumentos que eliminen la corrupción o el uso indebido del poder. Asimismo, descentralizar el poder y la economía para asegurar que el Estado sirva a todos los peruanos sin excepción. Mediante el Acuerdo Nacional nos comprometemos a desarrollar maneras de controlar el cumplimiento de estas políticas de Estado, a brindar apoyo y difundir constantemente sus acciones a la sociedad en general.

Declaración Universal de los Derechos Humanos

El 10 de diciembre de 1948, la Asamblea General de las Naciones Unidas aprobó y proclamó la Declaración Universal de Derechos Humanos, cuyos artículos figuran a continuación:

Artículo 1.- Todos los seres humanos nacen libres e iguales en dignidad y derechos y (...) deben comportarse fraternalmente los unos con los otros.

Artículo 2.- Toda persona tiene todos los derechos y libertades proclamados en esta Declaración, sin distinción alguna de raza, color, sexo, idioma, religión, opinión política o de cualquier otra índole, origen nacional o social, posición económica, nacimiento o cualquier otra condición. Además, no se hará distinción alguna fundada en la condición política, jurídica o internacional del país o territorio de cuya jurisdicción dependa una persona (...).

Artículo 3.- Todo individuo tiene derecho a la vida, a la libertad y a la seguridad de su persona.

Artículo 4.- Nadie estará sometido a esclavitud ni a servidumbre; la esclavitud y la trata de esclavos están prohibidas en todas sus formas.

Artículo 5.- Nadie será sometido a torturas ni a penas o tratos crueles, inhumanos o degradantes.

Artículo 6.- Todo ser humano tiene derecho, en todas partes, al reconocimiento de su personalidad jurídica.

Artículo 7.- Todos son iguales ante la ley y tienen, sin distinción, derecho a igual protección de la ley. Todos tienen derecho a igual protección contra toda discriminación que infrinja esta Declaración (...).

Artículo 8.- Toda persona tiene derecho a un recurso efectivo, ante los tribunales nacionales competentes, que la ampare contra actos que violen sus derechos fundamentales (...).

Artículo 9.- Nadie podrá ser arbitrariamente detenido, preso ni desterrado.

Artículo 10.- Toda persona tiene derecho, en condiciones de plena igualdad, a ser oída públicamente y con justicia por un tribunal independiente e imparcial, para la determinación de sus derechos y obligaciones o para el examen de cualquier acusación contra ella en materia penal.

Artículo 11.-

1. Toda persona acusada de delito tiene derecho a que se presuma su inocencia mientras no se pruebe su culpabilidad (...).

2. Nadie será condenado por actos u omisiones que en el momento de cometerse no fueron delictivos según el Derecho nacional o internacional. Tampoco se impondrá pena más grave que la aplicable en el momento de la comisión del delito.

Artículo 12.- Nadie será objeto de injerencias arbitrarias en su vida privada, su familia, su domicilio o su correspondencia, ni de ataques a su honra o a su reputación. Toda persona tiene derecho a la protección de la ley contra tales injerencias o ataques.

Artículo 13.-

1. Toda persona tiene derecho a circular libremente y a elegir su residencia en el territorio de un Estado.

2. Toda persona tiene derecho a salir de cualquier país, incluso del propio, y a regresar a su país.

Artículo 14.-

1. En caso de persecución, toda persona tiene derecho a buscar asilo, y a disfrutar de él, en cualquier país.

2. Este derecho no podrá ser invocado contra una acción judicial realmente originada por delitos comunes o por actos opuestos a los propósitos y principios de las Naciones Unidas.

Artículo 15.-

1. Toda persona tiene derecho a una nacionalidad.

2. A nadie se privará arbitrariamente de su nacionalidad ni del derecho a cambiar de nacionalidad.

Artículo 16.-

1. Los hombres y las mujeres, a partir de la edad núbil, tienen derecho, sin restricción alguna por motivos de raza, nacionalidad o religión, a casarse y fundar una familia (...).

2. Sólo mediante libre y pleno consentimiento de los futuros esposos podrá contraerse el matrimonio.

3. La familia es el elemento natural y fundamental de la sociedad y tiene derecho a la protección de la sociedad y del Estado.

Artículo 17.-

1. Toda persona tiene derecho a la propiedad, individual y colectivamente.

2. Nadie será privado arbitrariamente de su propiedad.

Artículo 18.- Toda persona tiene derecho a la libertad de pensamiento, de conciencia y de religión (...).

Artículo 19.- Todo individuo tiene derecho a la libertad de opinión y de expresión (...).

Artículo 20.-

1. Toda persona tiene derecho a la libertad de reunión y de asociación pacíficas.

2. Nadie podrá ser obligado a pertenecer a una asociación.

Artículo 21.-

1. Toda persona tiene derecho a participar en el gobierno de su país, directamente o por medio de representantes libremente escogidos.

2. Toda persona tiene el derecho de acceso, en condiciones de igualdad, a las funciones públicas de su país.

3. La voluntad del pueblo es la base de la autoridad del poder público; esta voluntad se expresará mediante elecciones auténticas que habrán de celebrarse periódicamente, por sufragio universal e igual y por voto secreto u otro procedimiento equivalente que garantice la libertad del voto.

Artículo 22.- Toda persona (...) tiene derecho a la seguridad social, y a obtener (...) habida cuenta de la organización y los recursos de cada Estado, la satisfacción de los derechos económicos, sociales y culturales, indispensables a su dignidad y al libre desarrollo de su personalidad.

Artículo 23.-

1. Toda persona tiene derecho al trabajo, a la libre elección de su trabajo, a condiciones equitativas y satisfactorias de trabajo y a la protección contra el desempleo.

2. Toda persona tiene derecho, sin discriminación alguna, a igual salario por trabajo igual.

3. Toda persona que trabaja tiene derecho a una remuneración equitativa y satisfactoria, que le asegure, así como a su familia, una existencia conforme a la dignidad humana y que será completada, en caso necesario, por cualesquiera otros medios de protección social.

4. Toda persona tiene derecho a fundar sindicatos y a sindicarse para la defensa de sus intereses.

Artículo 24.-

Toda persona tiene derecho al descanso, al disfrute del tiempo libre, a una limitación razonable de la duración del trabajo y a vacaciones periódicas pagadas.

Artículo 25.-

1. Toda persona tiene derecho a un nivel de vida adecuado que le asegure, así como a su familia, la salud y el bienestar, y en especial la alimentación, el vestido, la vivienda, la asistencia médica y los servicios sociales necesarios; tiene asimismo derecho a los seguros en caso de desempleo, enfermedad, invalidez, vejez u otros casos de pérdida de sus medios de subsistencia por circunstancias independientes de su voluntad.

2. La maternidad y la infancia tienen derecho a cuidados y asistencia especiales. Todos los niños, nacidos de matrimonio o fuera de matrimonio, tienen derecho a igual protección social.

Artículo 26.-

1. Toda persona tiene derecho a la educación. La educación debe ser gratuita, al menos en lo concerniente a la instrucción elemental y fundamental. La instrucción elemental será obligatoria. La instrucción técnica y profesional habrá de ser generalizada; el acceso a los estudios superiores será igual para todos, en función de los méritos respectivos.

2. La educación tendrá por objeto el pleno desarrollo de la personalidad humana y el fortalecimiento del respeto a los derechos humanos y a las libertades fundamentales; favorecerá la comprensión, la tolerancia y la amistad entre todas las naciones y todos los grupos étnicos o religiosos; y promoverá el desarrollo de las actividades de las Naciones Unidas para el mantenimiento de la paz.

3. Los padres tendrán derecho preferente a escoger el tipo de educación que habrá de darse a sus hijos.

Artículo 27.-

1. Toda persona tiene derecho a tomar parte libremente en la vida cultural de la comunidad, a gozar de las artes y a participar en el progreso científico y en los beneficios que de él resulten.

2. Toda persona tiene derecho a la protección de los intereses morales y materiales que le correspondan por razón de las producciones científicas, literarias o artísticas de que sea autora.

Artículo 28.- Toda persona tiene derecho a que se establezca un orden social e internacional en el que los derechos y libertades proclamados en esta Declaración se hagan plenamente efectivos.

Artículo 29.-

1. Toda persona tiene deberes respecto a la comunidad (...).

2. En el ejercicio de sus derechos y en el disfrute de sus libertades, toda persona estará solamente sujeta a las limitaciones establecidas por la ley con el único fin de asegurar el reconocimiento y el respeto de los derechos y libertades de los demás, y de satisfacer las justas exigencias de la moral, del orden público y del bienestar general en una sociedad democrática.

3. Estos derechos y libertades no podrán, en ningún caso, ser ejercidos en oposición a los propósitos y principios de las Naciones Unidas.

Artículo 30.- Nada en esta Declaración podrá interpretarse en el sentido de que confiere derecho alguno al Estado, a un grupo o a una persona, para emprender y desarrollar actividades (...) tendientes a la supresión de cualquiera de los derechos y libertades proclamados en esta Declaración.

SÍMBOLOS DE LA PATRIA

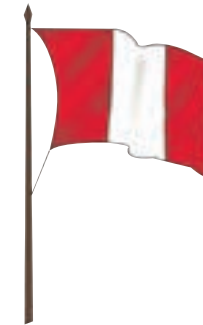

BANDERA NACIONAL



HIMNO NACIONAL CORO

Somos libres, seámoslo siempre,
y ante niegue sus luces el Sol,
que faltemos al voto solemne
que la Patria al Eterno elevó.

HIMNO NACIONAL



ESCUDO NACIONAL

DISTRIBUCIÓN GRATUITA
PROHIBIDA SU VENTA