



ACCHUAR

Wijiai unuimiarta

4

Takakmati kirak



PERÚ

Ministerio de Educación

Viceministerio de Gestión Pedagógica

Dirección General de Educación Básica Alternativa, Intercultural Bilingüe y de Servicios Educativos en el Ámbito Rural

Distribución gratuita
prohibida su venta



Wijai unuimiarta

4

Takakmati kirak



Ministerio de Educación

Ministro de Educación
Idel Alfonso Vexler Talledo

Viceministro de Gestión Pedagógica
Guillermo Manuel Molinari Palomino

Directora General de Educación Básica Alternativa, Intercultural Bilingüe y de Servicios Educativos en el Ámbito Rural
Elena Antonia Burga Cabrera

Directora de Educación Intercultural Bilingüe
Nora Delgado Díaz

WIJIAI UNUIMIARTA
Aprendamos juntos 4 años - Achuar

Elaboración del contenido
Nely Vela Dahua

Revisión del contenido
Antonio Fachin Tapayuri

Asesoría y Revisión técnica (DIGEIBIRA-DEIB)
Lucía Nina Medina

Ilustraciones
Lucas Pinazo Durand
Gustavo Cristhiam Arias Salero
Archivos DIGEIBIRA

Diseño y diagramación
César Adolfo Yeckle Castro

Cuidado de la edición
Rosa Elena Giraldo Narrea

Segunda edición, 2017

Tiraje: 630 ejemplares

Impreso en:
Quad/Graphics Perú S.A.
Av. Los Frutales 344, Ate, Lima 03, Perú
RUC 20371828851

Impreso Septiembre 2017

©Ministerio de Educación
Calle del Comercio 193, San Borja
Lima - Perú
Teléfono: 615-5800
www.minedu.gob.pe

Hecho el Depósito Legal en la Biblioteca Nacional del Perú N° 2017-11560
Este material no se puede reproducir total ni parcialmente sin el permiso expreso de los editores.

Impreso en el Perú / Printed in Peru

Iniakmamu

Uchi ashmankuch tura nuwawach chintiuk (4) musach weutirmin penker inintintusan juu kirakan jiisar unuimiararat tusan umikjai, juna aujiniak tura ainiak unuimiararat tusan.

Juu kiraka juninkia unuimiartatme, jea jeammau, pinin najanmau, aja takamu, entsa nijiamu, awanmau, mama aramu tura jamanch ijuamu, echankin najanmau, ikiamnumia yuran juukar yuwamu, Junaka aujmattsartatui, apach, nuchuk tura unikiartin ainiau.

Ji juntn' takati takakum unuimiartatme nekapmat, aujat, aakmat anentruk, aujmatat, aujmat, ujaimat, nakurut, patatin, penker wainmankatin, arantuniktin, anenit, anturnait, tsankurnairatin ainia nuu unuimiartatme.

Juninkia ainiawai takat amek takastin, tura tsaniakmaurumjiai takastincha ainiawai, aparmiji, nukurmiji, yachimjiai, tura umajim, kaim nampuaru yainmanti takastincha ainiawai.

Wakeraji, juu kiraka juna jiisar takainiat penker warasar nii tsaniakmaurijiai nii unuikiartintrijiai nakuriniak penker unuimiararat tusar.

Nuniasha inintimji, kiraka juu amin yainmakat tusar.

Shiram wainkata kiraka juu aminia asamti, shiram waitkat tusa wakerawai yainmaktas wakerau asa.

Tuu ati.

Winia naarka.



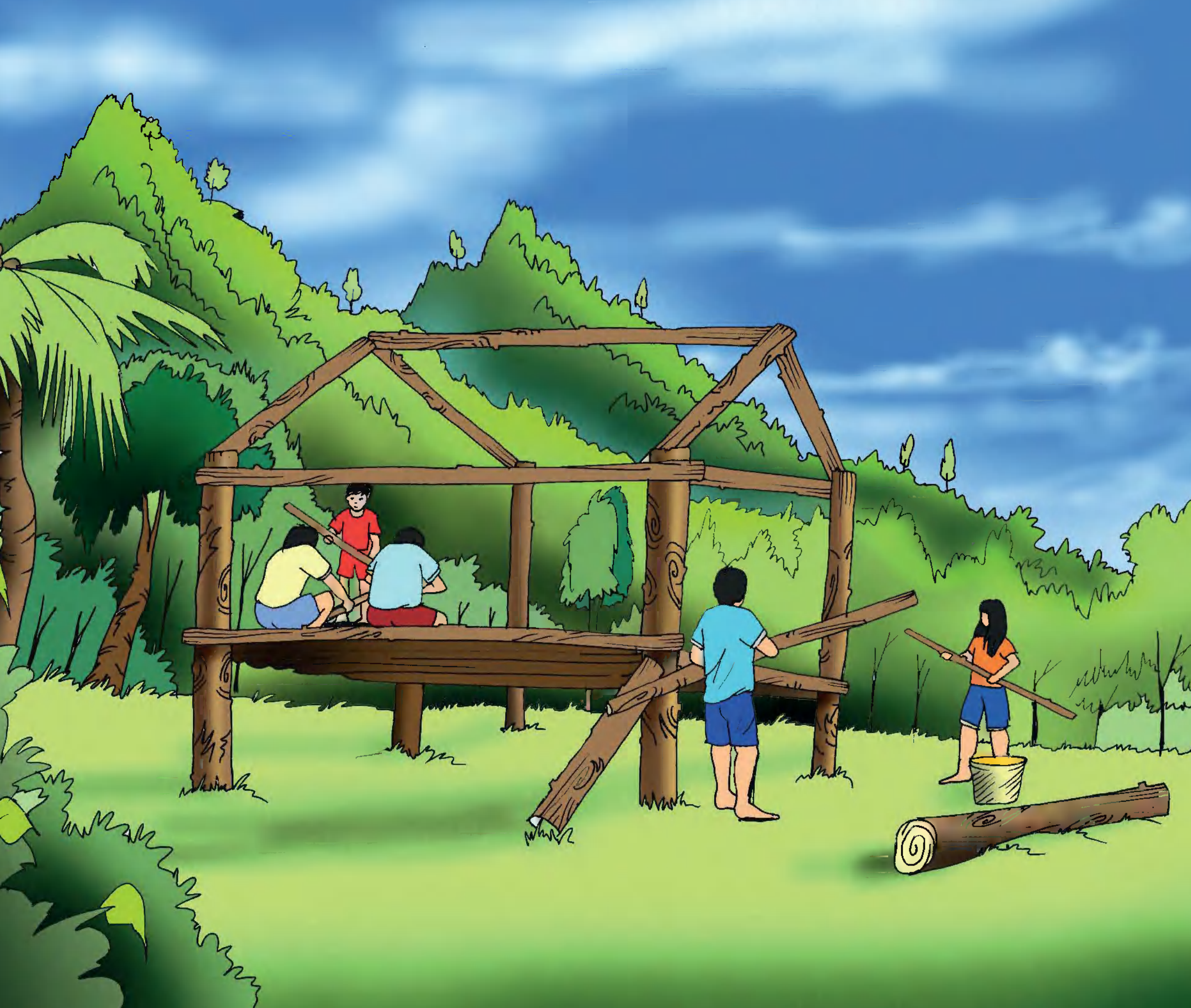



Kankamu

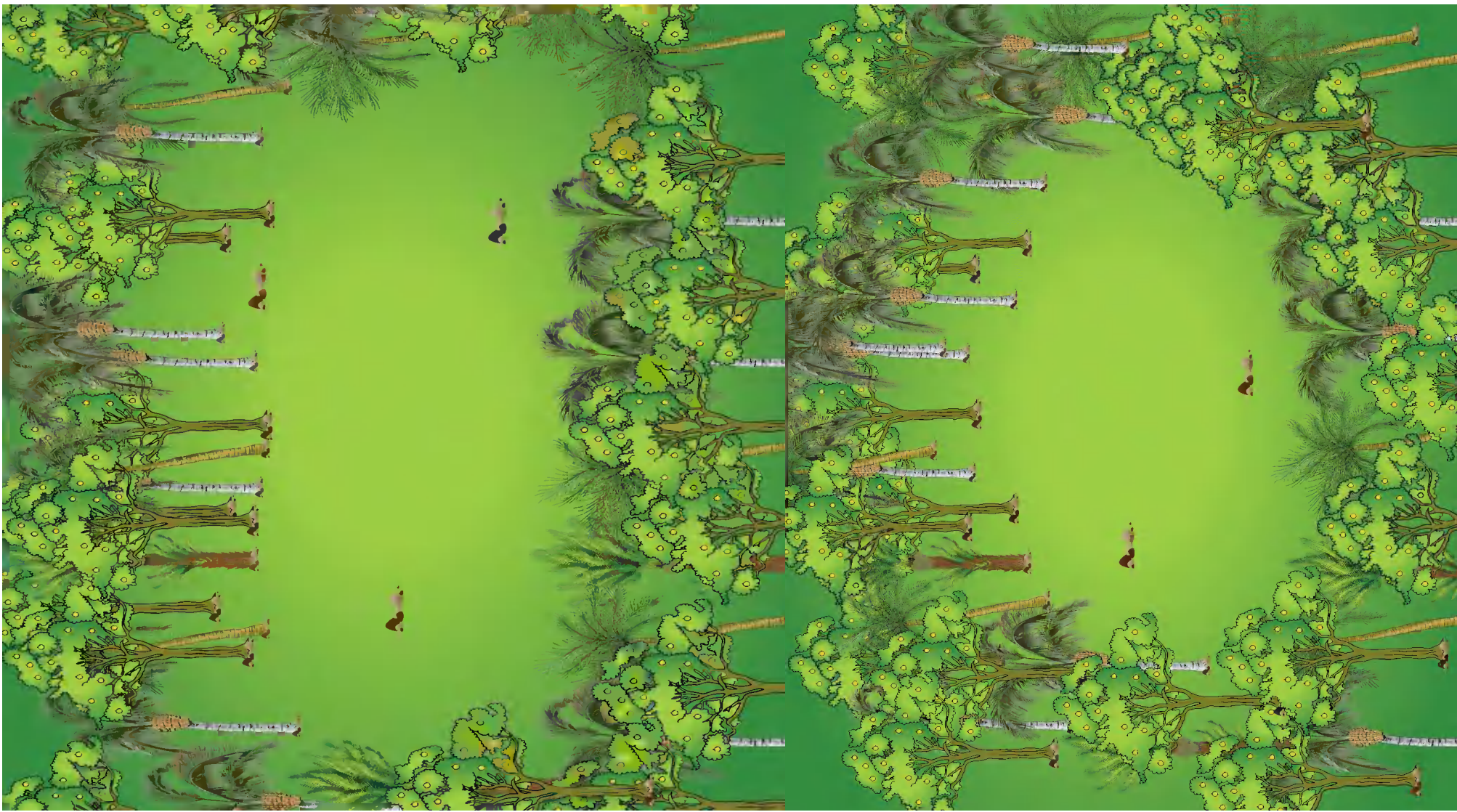

Nunka penkernun eakar jeaka jeamkatnuitji

- Nunka jeamkatin weriar jisar aujmitsatatji warukuki, tura nunianka uchi yantarin wekajiniawai.
- Ame waintkamuram pachisam nakunkata.
- Juunikiam nakumkata papiniam nunca metekashi nuu.
- Uchi nuinartiniu ininrawai warinchuri nakarustinina penkerashi tuu inintriniawai.
- Uchiji jea jeamkatin nunka ankamu jiaji tura achi nii nuimiatrin waketkiar nunka pachisar nuikiartiniu ajainiawai.

Nunka jea jeamkatin tantekam nakumkam nunia yakarta.

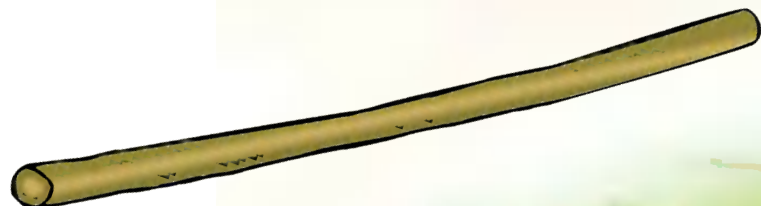
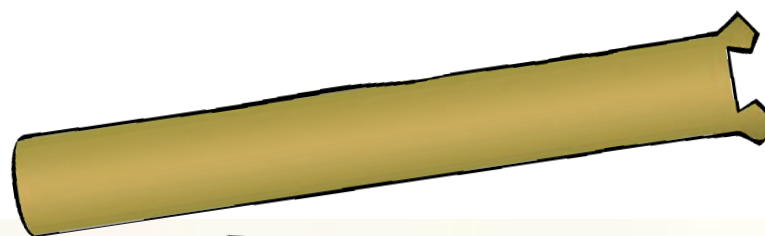
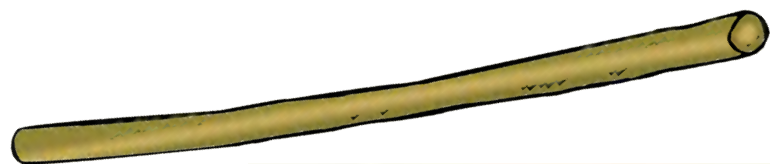

Winia naarka:

Warinchu jea jeamtai ainiu

- Jeasha itieurjeamtayi tusar aujmatmau.
- Nuikiartin uchin iniawai chichakarti tusa.
- ¿Jeemsha warukuitia?
- Wari numia jea jeamkatasrisha jutayi.
- Nuikiartin jisar amisar numi, nunia nukam shiram umik takawai arum uchin akanturmi tusa.
- Nunianka jisar juuniniawai uchi matsarartas nukancha nukanak nukanak tura yumichincha yuminiak yuminiak, tura chikich ainiuncha.
- Nuikiartinjai jea awan keamun najaniniawai kirak juunnum tura nunianka nakuminiawai aakmatiji.
- Kichik, kichik aujmatsaitatui nii jee nakumkamuria nuna.



Winia naarka:

Nuka jea jeamtai ainiu

- Juunt ainiu nuikiartin seawai, nukan nuimiat itiarat tusa chapi, katira nuke.
- Nunianka mash itiarantai, uchi juni itiarantai nuka suwawai. ¿Nuka jusha wari nukenki chapiashi, katirasha? ¿Tura wari naartinuitia? ¿Warukua nukasha ainiawai tura nuniasha warinma metekchausha awa?
- ¿itiura nukasha penkersha wainkatnuitji tura nunia arak ainiusha? Tura nunianka papiniam nakumkar penkeran matsaimawai chapi napiarmaum, napiarmau najaniniawai jeachin.
- Takakmati papi susata kirakjai patkam.

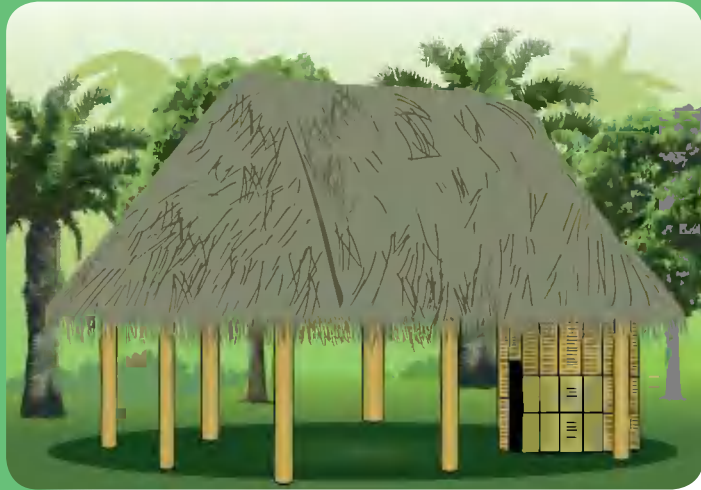

Winia naarka:

Pachin jea ainiua

- Nuikiartin jea jeamkur enentrutin ninki nintimias jiiki uchiainia jintiawai. Tantee jeachi ame atai tsaansha sukurtsui yumisha chuptachui, wa, wa, wa.
- Uchi ainiu jeem nakumkataram titinuitji tura nunia umisaramtai tantee najansaramtai iniakmastaram atumi jee nakumkamuwach.
- Niqkmasar umisaramtai iniastinuityi.
- Metekak jea ainia tusar.
- Nunianka jeawach nakumramu metek ainiu nuke, nuke ainiun matsarartinuitia uchiwach.

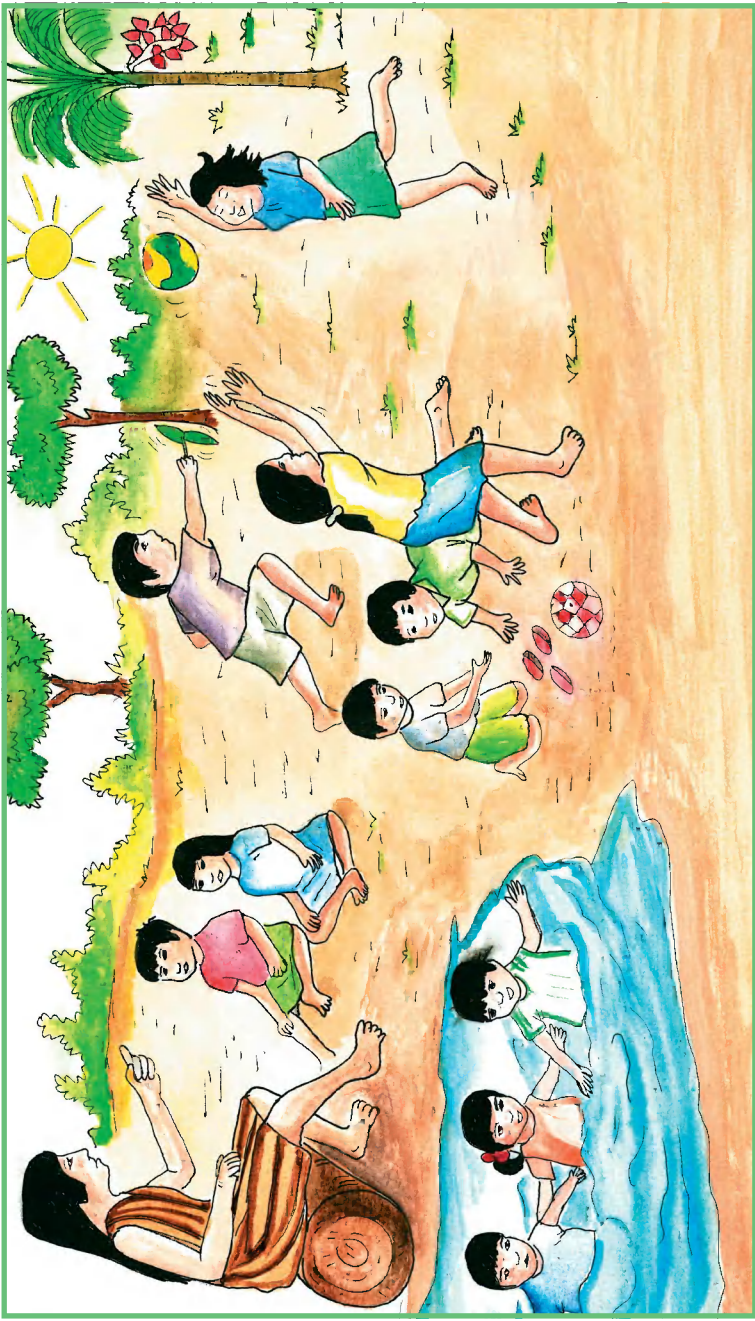

Ipiakratar jea jeamau

Ipiajmaji jea jeamkami tusar.

Uchi iruntrar juuntan inintru wanawai itiur jeasha jeamtaiki nuna ujatmakat tiar.

Unuimiatiniam weketkiram takat takakmasmau pachisrum aujmatsataram.

Uchi susata takakmati ainiu jiisarat tiri tura nunia nakumkama ainiu jisar wariniak takainia nuna pachisar aujmatsartatui:

- ¿Wari takata takatayi ipiaknumsha?
- ¿Wari takata takaji ipiaknumsha?
- ¿Waruka ipiakratarsha takaji?
- ¿Paapi kanturta jeann nakumak yakarat timi?



Winia naarka:

Painim pauriji

- Nuwik enen nuimiarmaji nuu wakekir inintraji uchiji.
- Nuikiartin numin painin, paurin tura amis juuwawai turam tai uchi achikar nunianka paatkar jiniawai, apusha, sarmashi, chichiriashi tusar.
- Tura nuimiatnumka jinkiar ankan wajasar chikich numi painmia tumantiniun eaniawai.
- Uchi kichik kichik nakuminiawai numirin apurin, tura numiri tsererchirin.
- ¿Warukaria yuumaji jea jeamkatasrisha?
- Paapinian jea nakumkamuana painim, pauri.
- Charukam nujkata.

**Paini nunia jea pauri ainiau nakumramu charuram matsakta tuni matsarminjia nuu
jiisam.**



Winia naarka:

Warinchu jea wankur takati ainiu

Warinchu jea awantatar uyumati ainiu.

Jea jeammau pachisar aumatsarmi, jean jeaminiantikia werir jistinuitji:

¿Nunia iniastatji?

Wari warinchua uyumaji jea jeamkatarisha unuikiartin jea jeamtai ainiu niakmastinuitia tura artinuitia tatannum num naari aartinuitji uchiji.

- ¿Ainiawai tusar tiniamtai?
- ¿Itiura jeasha jeamtayi?
- ¿Yachia yakisha waush armayi?
- ¿Yachia nunkasha pujuinia?

Papiniam matsarta takati ainiana nuu.

Aujmatmau antukam aimkata inintramu ame aujmatmaunumia antukmaurum yasakamuji (x) shait tsentsakta.

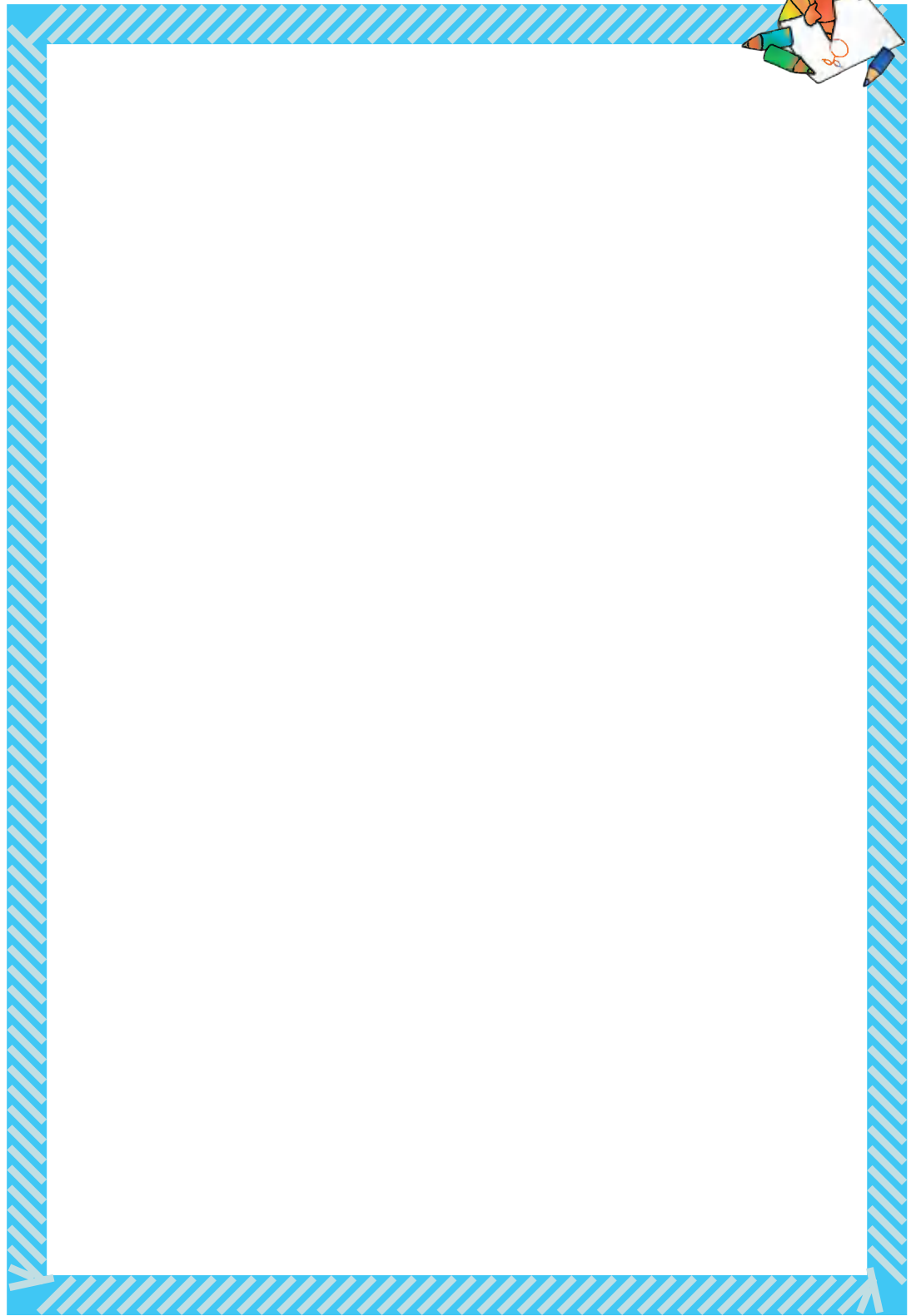
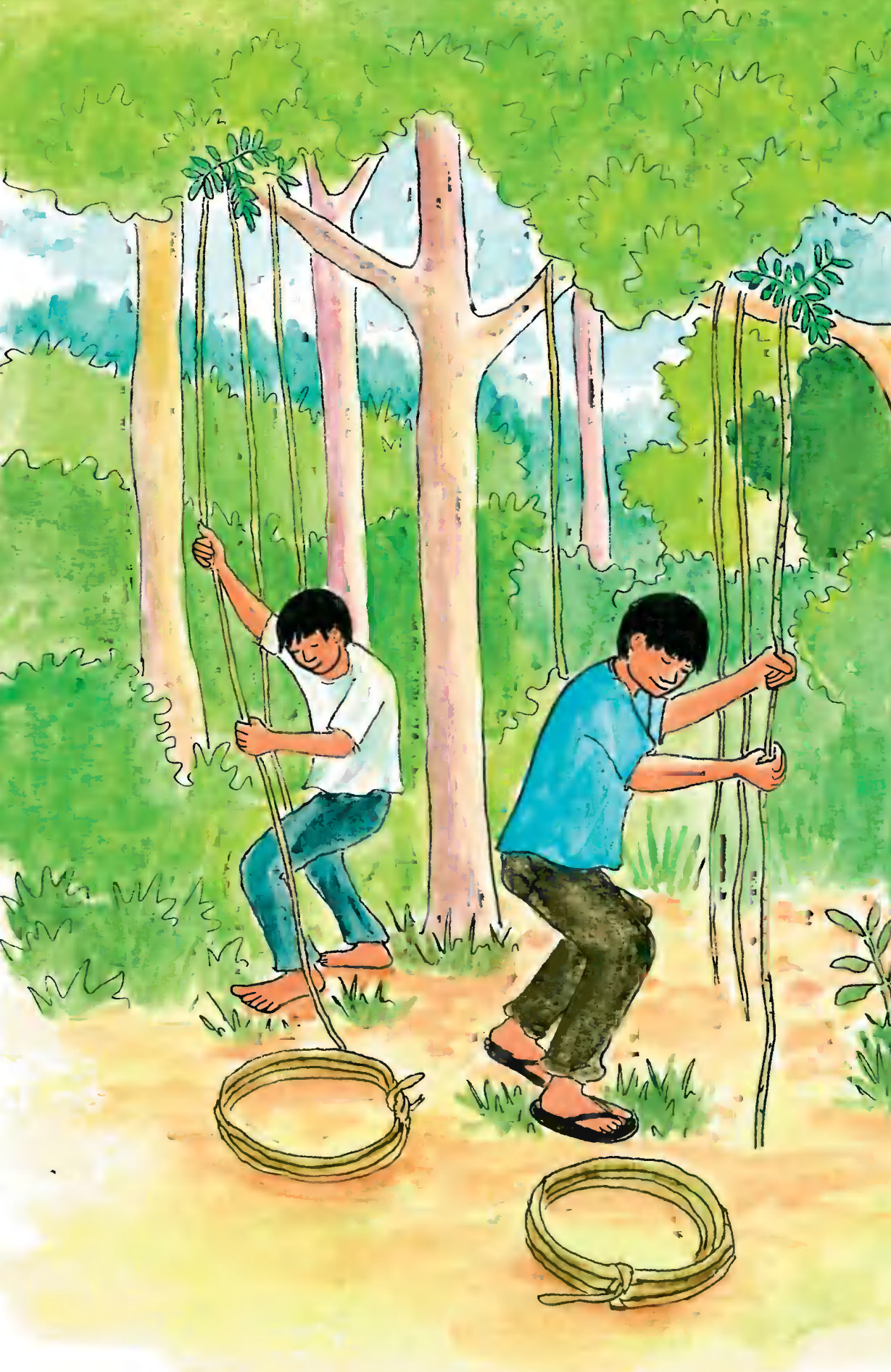

Winia naarka:

Tamshi kaap numi jimkiati

Kaap numi jimkiati.

Kaapjainkia uchikia awatchattayi, turachmata uchi watsaruwach wajau tiniu aarmayi

- ¿Kaapsha wari jimkiatnia shirmaitia?
- ¿Tuniana kaapnasha naturin armaa?
- ¿Paapiniam nakumkata, turam aattrata naari, turam ame tsaniakmauram ujakta nekawarat warukuki warin iturta?
- Yanchuikia ii apachrinkia kapjai jimkiur aimiayi jeankesha nukuiniak kapjai jimkiawar japiu armayi, tarayat yamaikia naeksoguilla jimkianiawai.

Sapi achintikrata aints yaki pujuiniau tura nunca tauti, jacha achintikrata aints emrar nunia uku pujuiniau tura kaap aints nunca pujuiniau.



Winia naarka:

Nuka napiarmau wantatin

Napiarmau

- ¿Uchi iruntrar juunt inintruweaji itiurak chapincha napiush aarma tura chapincha wari wantatniumma shirmaitia?
- ¿Nuimiatnum pujusam jista tura atrata kichkimsam warinukak ainia nuu?
- ¿Warukuitia? ¿tuni tsaapayi?
- ¿Waruka nukasha shirmaitia jeawantatniusha?
- ¿Uchi nuiminiawai chapi napitin?

Paapi susata aarak nakumkamu kuiniak unujkati.

**Chapi nuke pachisam aujmattsata tura nukuch itiur jintinramama nuu
inintimsam chapi napiaram awantata.**



Winia naarka:

Jeanmosha yachia pajuinia

Nuikiartin iniaktawai aints jeana pujus tura nunia jean pachis aujmatun nakumkamun.

¿Yaa ainiawai?

Tura uchin inintrawai yachia pujumia turar tiniawai weuri

Inintrusta uchi:

- ¿Yachia a tumi jecha pajainiawai?
- ¿Naarisha yachia?
- ¿Jeanmasha warinia takainiawai?

Najmarar nakuriniawai.

Nakumka ame weuram pachirum, turam tsaniakmauran ujakta nii nari ainiu.

Ami iniuram nakumkata nunia amesha nakummamkata, nunia ami tsaniakmaurum ujakta ami weurmi naarisha yachik ainia nuu, nunia wariniak takainia nuu.



Winia naarka:

Junis ati tamau

Jintinkratatin ame takasmaurumnia paan iniakmasta ame wakerukmaurum,
nuniasha itiuur ii pujutri kajinmattsuk unuimiartinki tamau unimiartinki tamau
unuimiarmame nuu paan awajsata.

**Ii pujutri kajinmattsuk unuimiartiniuitji tusar aarmaji nuu paan
iniakmasan nakumkam yakarta tura nunia charurta.**





Nuwe najanmuu

Auju



Yachuikkia aujuka iin juntri aumatsamunmaka nuwa ayayi, tiniu armayi. Turamu nunwam aintsi Nantu naartin nuwatkau tura nawatak ikiamnum weak, yuwin nakar awitia tusa ukukiu.

Tura ikiamnumia taa yuwataj kama, aet painkamu wainiak chicharak" wii tsamarun akaran ukukmiaja nukai aetai.

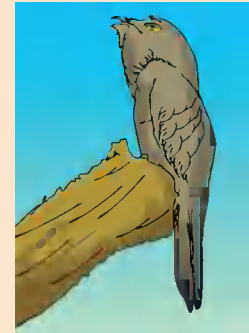

Tu iriam auju aimiak" winia yuwaru nawantri painkamun wainkar yuwija yuwija tiniamtai ukatin suwakun mash amukan yamarman painkajai" tu ujau aishrin, tiniu armayi. Nuka ninki yuwa amuk tu aishrinka ujau.

Tura kashin tsawar, Nantu ataksha ikiamnum wetas yuwin nuwari awitia titias, nakar chicharak" ikiamnum weajai yuwi awim nakarkata" tau, tama miatrusan auju yuwin ekenak chichak" ja wari naru naru tau" tama wari wari narukamtai yuwa umis ataksha nunisan yuwi aetan akak nakar iniarak aishin nakaku.

Tura yuwak, ataksha nunisan inintrak" nuwaru yuwi tsamaru nakaram painkata timiaja, nusha ataksha kashincha ikiamnum wea jak pirkanam, jii pujurmaitai yuwin painiak chichak ja wari naru naru taun antuk, wari kuwanki ikiamnum wewa nunisan ta yuwatas jiamaitiat yuwi kuwir painkamu wainiak nunianka Nantu kajek apari Etsa pujamunam nayaim piniam wemtai Aujusha nisha warinchurin, unkuhpun nunia tsapa pachim ainiau juuk weu.

Turau wainiat Nantu kajeku asa, naekri nenamurin charutak janar naisamu asamtai, Auju iniarak yapak nuwent yaparu turamunmaya nuwe yamaikia tuke nuwajai.

1. Wari pachisa ujmatun.

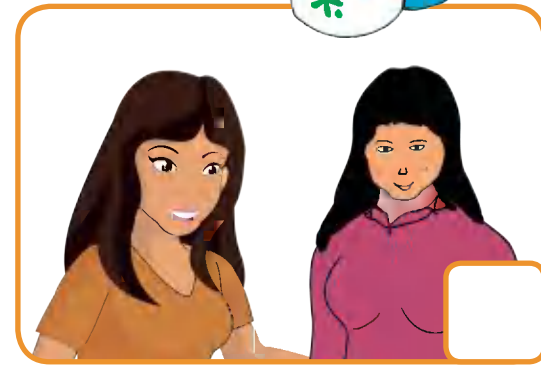
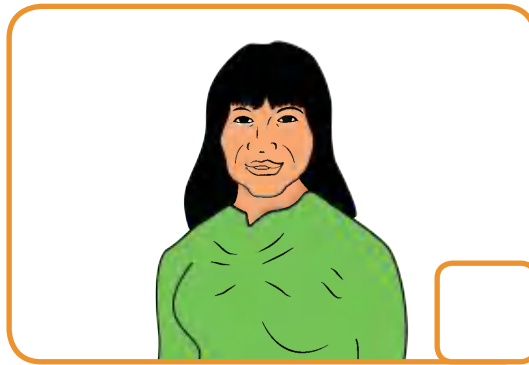
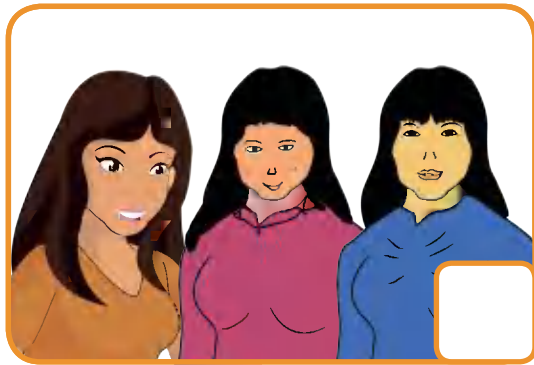

2. Wari awakua puju miayi aujusha jeanmasha ni aishiri ikiam num weamtaisha.

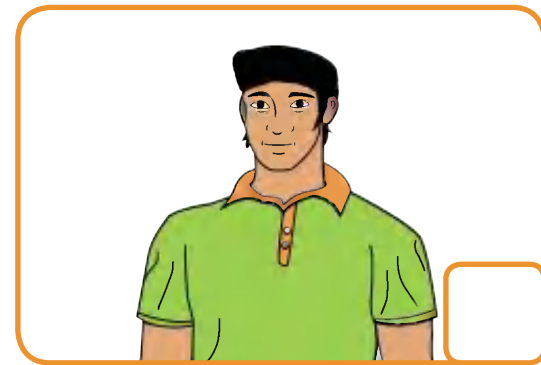
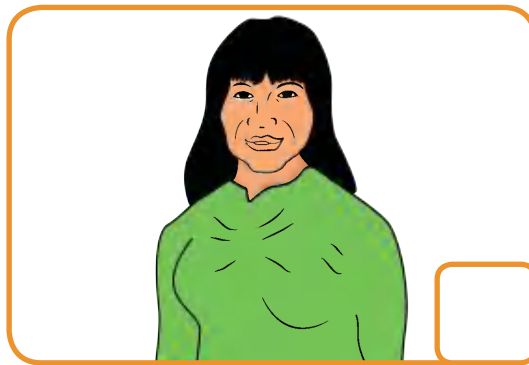

3. Warimpia nuwejisha najantayi. Nakumkata.



Winia naarka:

Juni pujawai nuwe

. Iniaktusta uchiji nakumkamu turan iniasta:

- ¿Auju aujmatiniau antinkuram?
- ¿Itiura jutniayi?
- ¿Warinia ujatmaji?

Tserkata auju aujmatmau. Takakmati papinium auju aujmatmau ausata.

Aujuka yanchuikka aints nuwa tiniu armayi tura aishrinkia Nantu tiniu armayi.

Tura aishri ikiamnum wetas yuwin akar nuwaru awitia wii tana yuwami tau tiniu armayi.

Turaya auju ninki mash amuk anankamiayi turam Nantuka kajes Nayaimpiniam tuke wemiayi, tachatnium.

Uchi ujakarta aujuka aishrin aneak turachkusha nantu tsapuamti pee jutniayi tusam.

Uchi auju juutmauri nakumkataram titia, tura etserkarti warukakun timia kuntuchuchincha juuta.

Takari papi uchi susarta auju aujmattsamu aarmauji turam aujsataram titia. Aujsataram Auju nakumkamu jiisrum.

Usata juu aumatsamu nunia aikta.



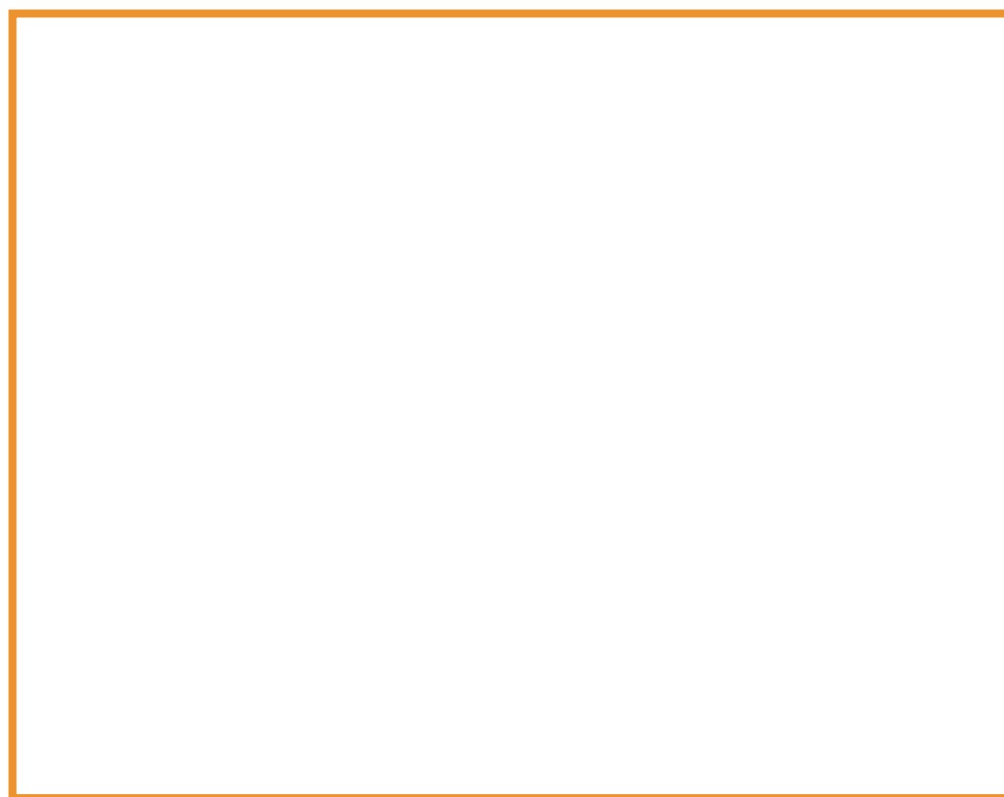
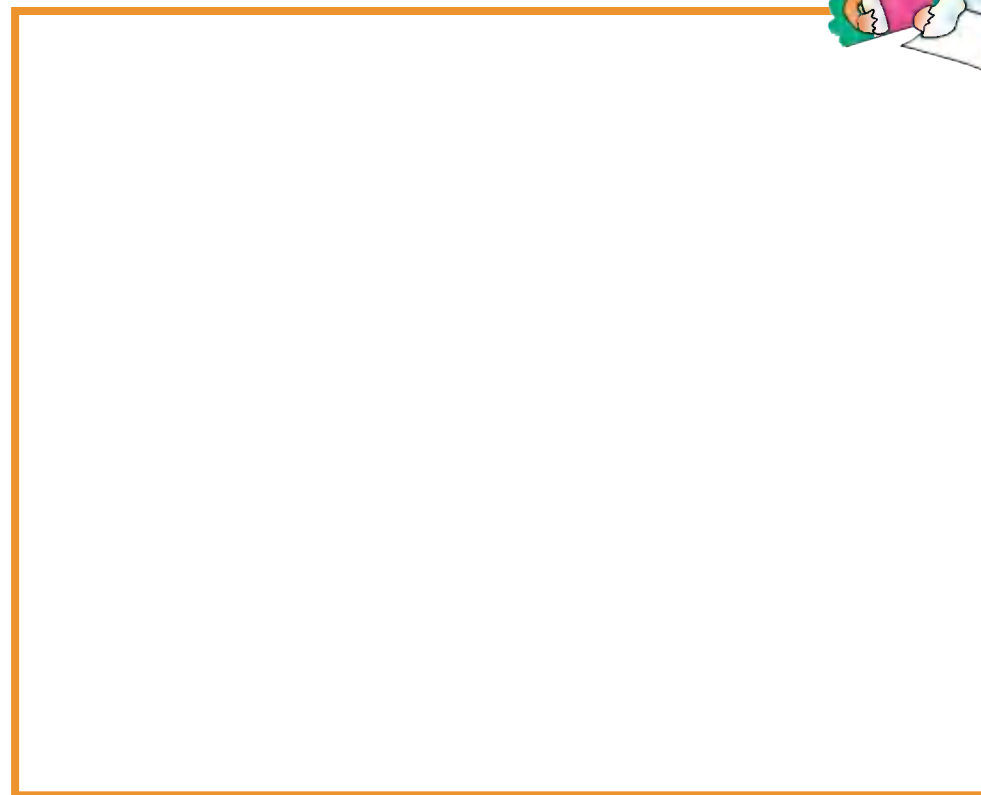

Itiura pachimtayi nuweshu

Aujmattsami nuwe takati pachisar, nuniasha warin takati nuu.

Chikich kintiati nukuach nuwe itiur pachimtayi nuna ujamakmaji nuu pachisar chichasmi.

Nania aujmattsami nuwejisha wari najanta nuu nuniasha warijia takatayi:

¿Tuwa ainia nuwe najankur takatisha?

Aarta tatanum turachkumsha papinium nii uchi turaminia nuu.

Aarta patkam warinchu metek ainiau:

- ¿Wari warinchua jeamasha pujuiniawa?
- ¿Tuwa ii takasmincha ainiawa?
- ¿Tuwa uchi takaschamniausha ainiawa?

Uchi papi susata nuwe najankur warinchu takati ainiun nakumkarat tusam.

Takakmastin papi uchi susata turam aujtusta inintramu.

Chintiuk ankannum nakumkata takakmati taama nuu.

Jista wakan tura nunia aujmattsata itiura nuwen pachimia nuu. Tura nunia matsarta itiur nankamama nuu.

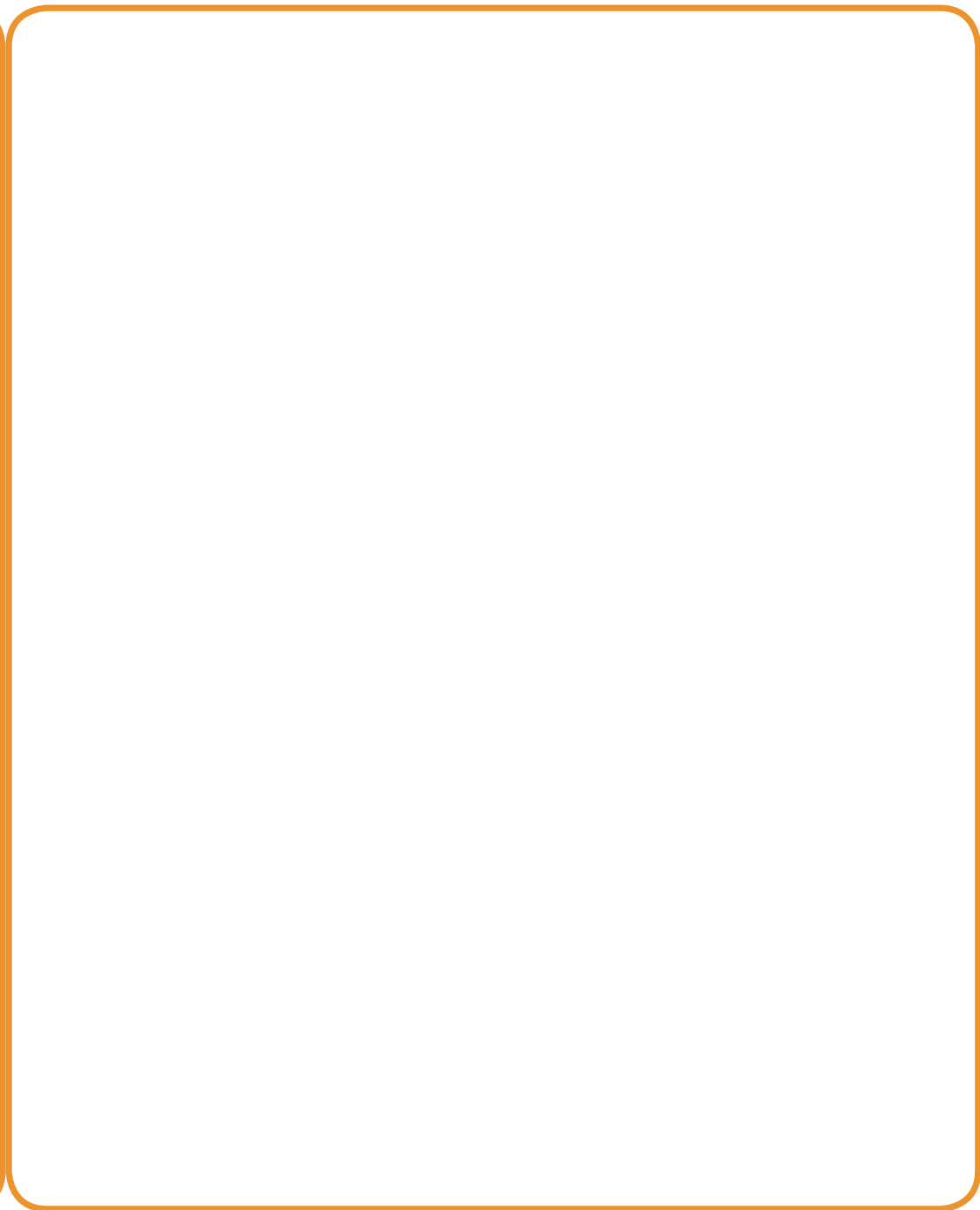
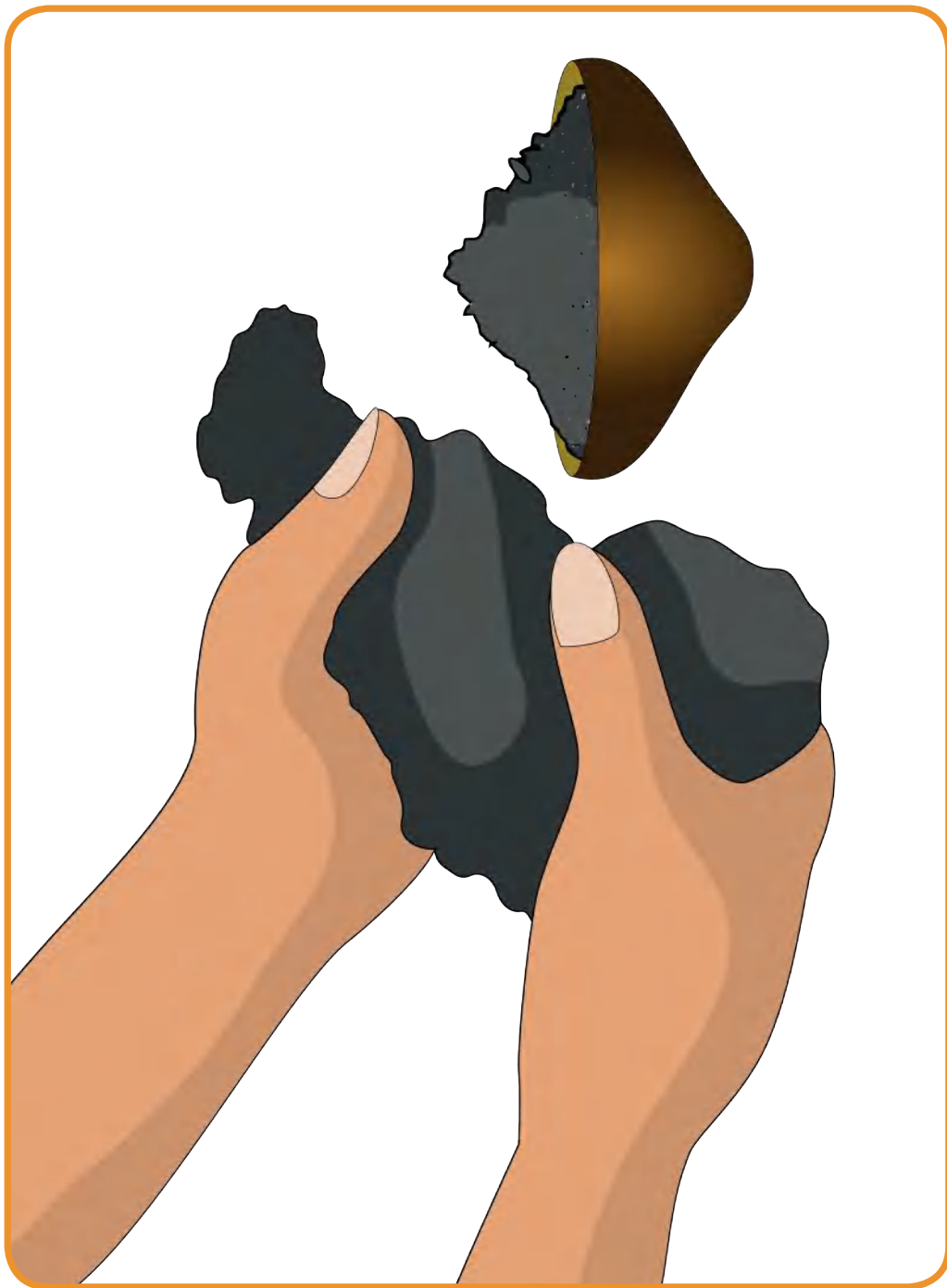

Nuweji warinchi najankur takati ainia nuu

Warin nuweji najantayi.

Nuimiatirmin nuweji najanamu jukimniau amatinkia jukitia muits, pinin, chiniak, tachau, yukunt.

Iniaktusta uchi ainiau nuwejii najanamu turam iniasta:

- ¿Warukuitia?
- ¿Jemnisha awa?
- ¿Wari itiurkartasa takausha armayi?
- ¿Nuniasha wari warinchi najanamua jemnisha pujuiniawa?
- ¿Wari itiurkartasa junasha takainiawa?

Pachim nuweji papinium najanamu iniaktusta turam iniasta kichik kichik nii naari nuniasha wari itiurtaya ainia tusam.

Warinchi nuweji najanamu uchi junij matsarmi tamati matsarta.

Matsainiawai pachim nakuruti warukuki nunarin jiisar. Nunia etseriniawai warukan aisha matsakarma nuna. Takakmatipapi susata warinchi nuweji najanamu ainiaun juukar matsakarat tusam.

Warinchi nuweji najankamu ainiau wari itiurkatniuk ainia nuu jiisam tiupich, juunt ainiau nunia usarmauri warukuk ainiau jiisam matsakta.

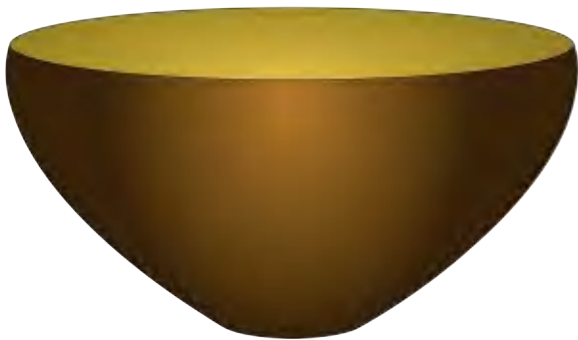
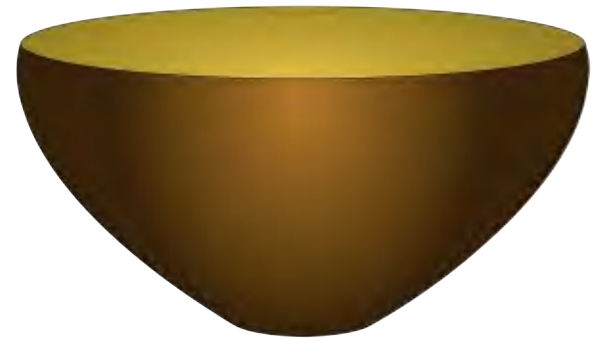
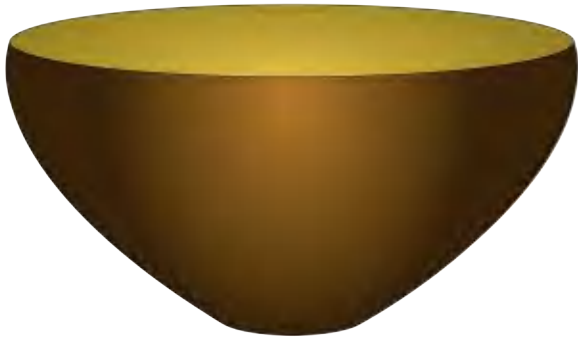
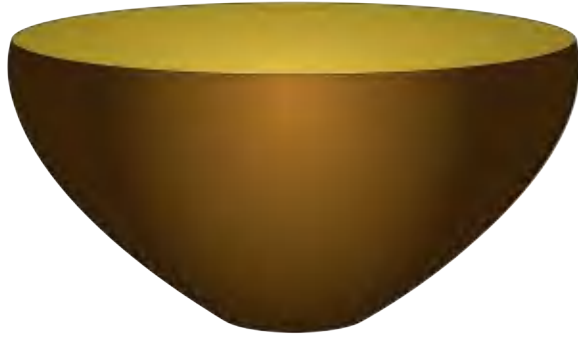

Winia naarka:

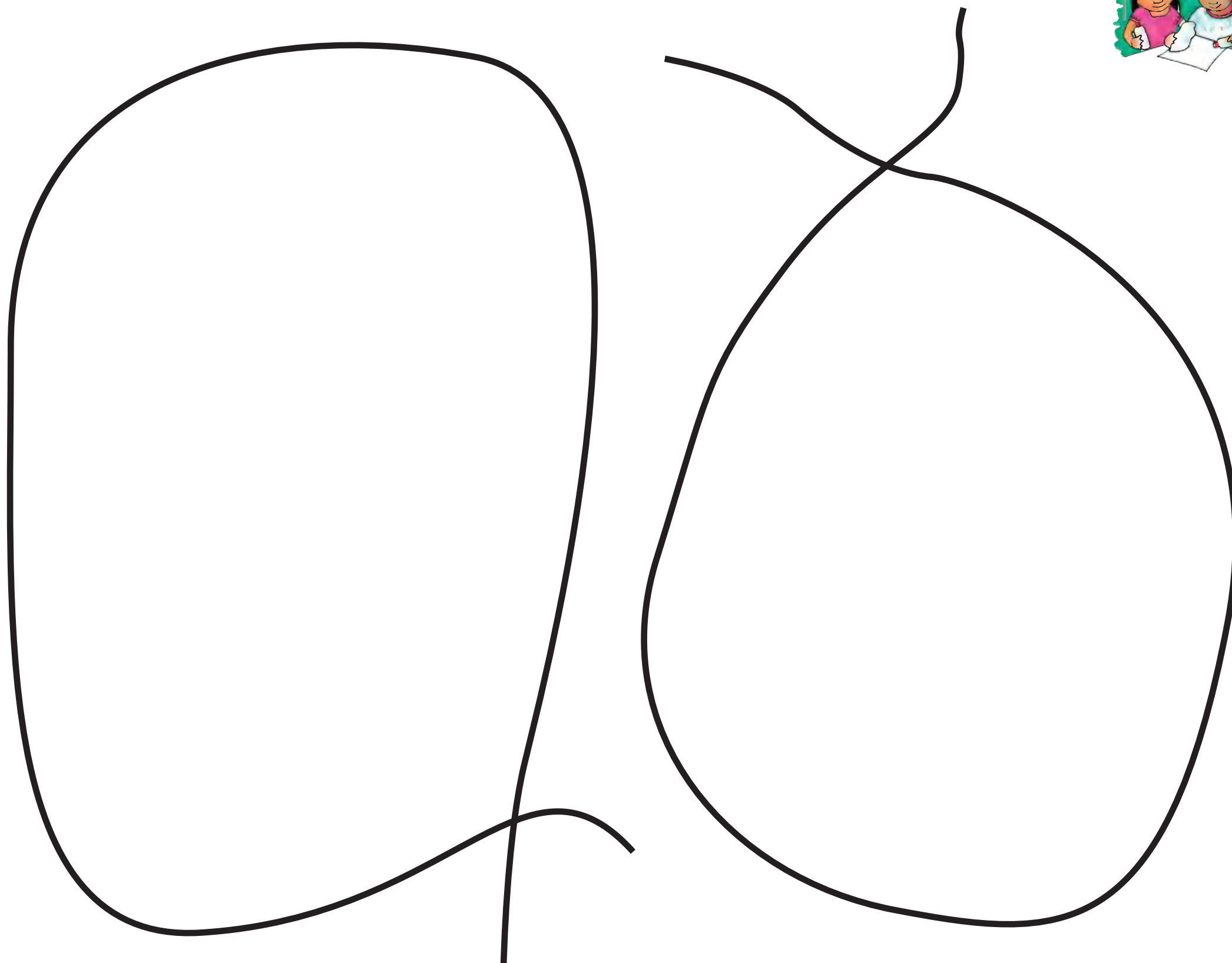

Winia naarka:

Nuweji warinchu najankur takati ainia nu

Nuwe pachisar aujmatji tura wari itiurkatnuitji nuwejisha najantayi.

Patatiniam ekenratatji uchijisar, achikar nunia aujmattsarat itiura takatayi jeanmasha:

- ¿Wari itiurkatniua muitscha penkeraitia?
- ¿Wari itiurkatniua pininsha penkeraitia?
- ¿Wari itiurkatniua tachausha penkeraitia?
- ¿Wari itiurkatniua chinkasha penkeraitia?

Nakurusmi nukuach pininum jamchin surau. Nunia chikich warinchu ainiauji.

Takakmati papinium jsar wariniak itiurinia nuna nekainiawai tura nunianka charurar turachkusha yakarar urarar anujiniawai nu tuni nujkamniawi nu.

Warinchu nuweji najankamu ainiau naari iniairata, tura wari itiurtain ainia nuu pachisam aujmattsata, tura charuram anujrata tunin anujramin ainia nuni.

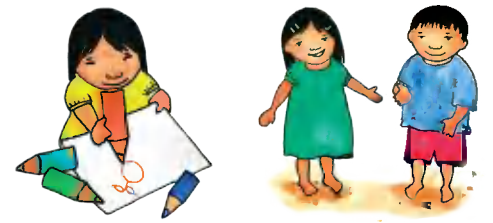

Wikia wekaichawitjai tuke jearun
pujuwitjai turayatun wiarmamramtaikia
mash wakerutinjai.

¿Yachitja?

Nuweji najantan itiur unuimiarariawak nu pachisar aujmatmau aumattsata

- Uchi nukuch nuwe najantan itiur unuimiarariawak nuna aujmatmati antiniawai.
- Yachik pinin, tachau, muits najan tancha nekapmaya nuna aujmatmaun antukar nekainiawai
- Uchi wainkarat tusa nukuch pininkian najanui unuimiatiniam.
- Uchi nuwawach ainiau nuwen tatannum yariniawai.
- Uchi ashmankuch ainiau aujmatiniawai itiurak nuwen nukuch najanama nuna.
- Pinin nakumkamu ainiau jisar tiupchinmaya nankamsar juunnum irumrar matsainiawai.

**Aujmatmau nakumkamuri jisam nekata tura nunia inintramu aikta yasakamuji (x)
shait tsentsakam aujmatmaunumia antukmaurumia nunia.**

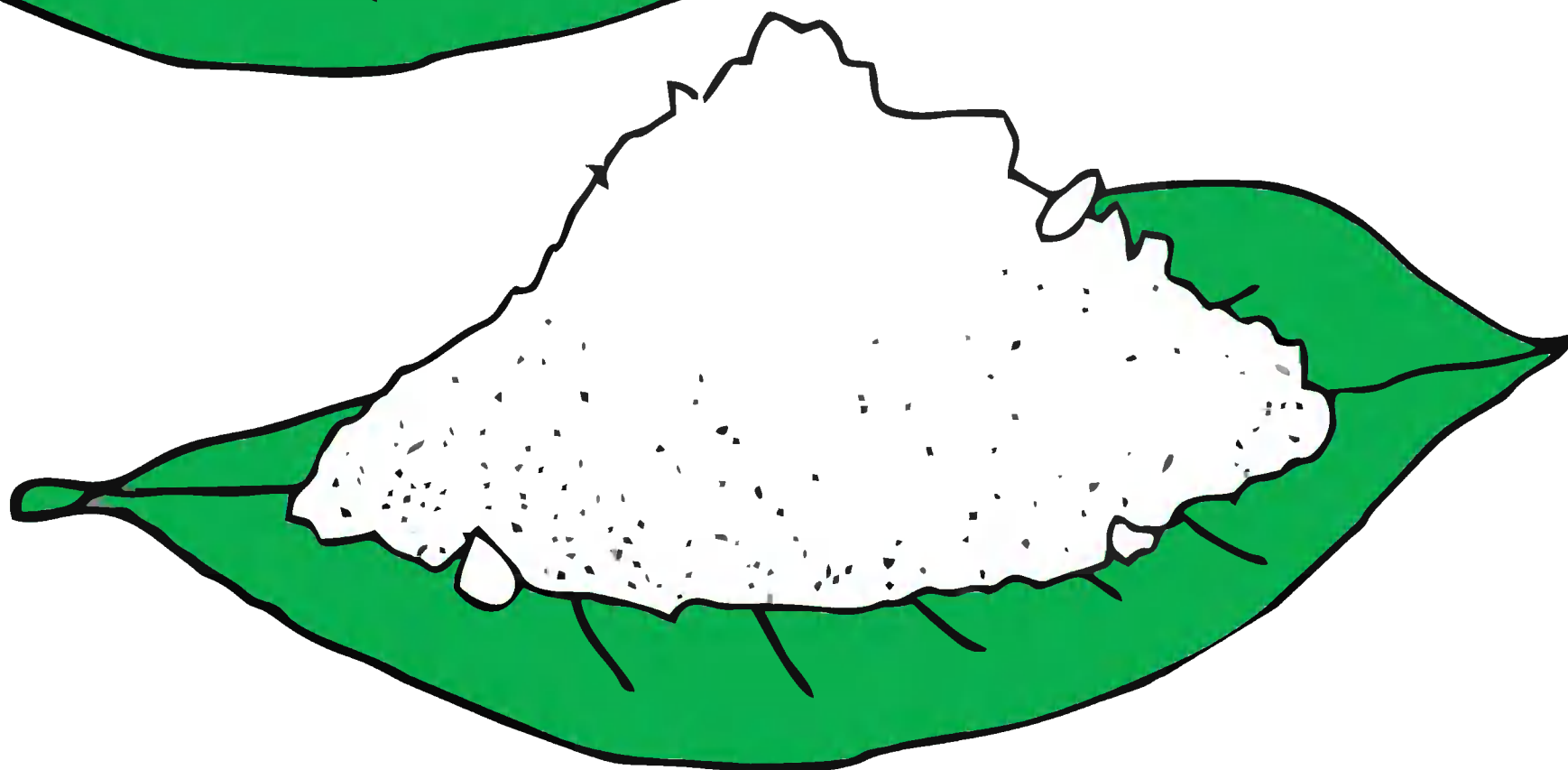
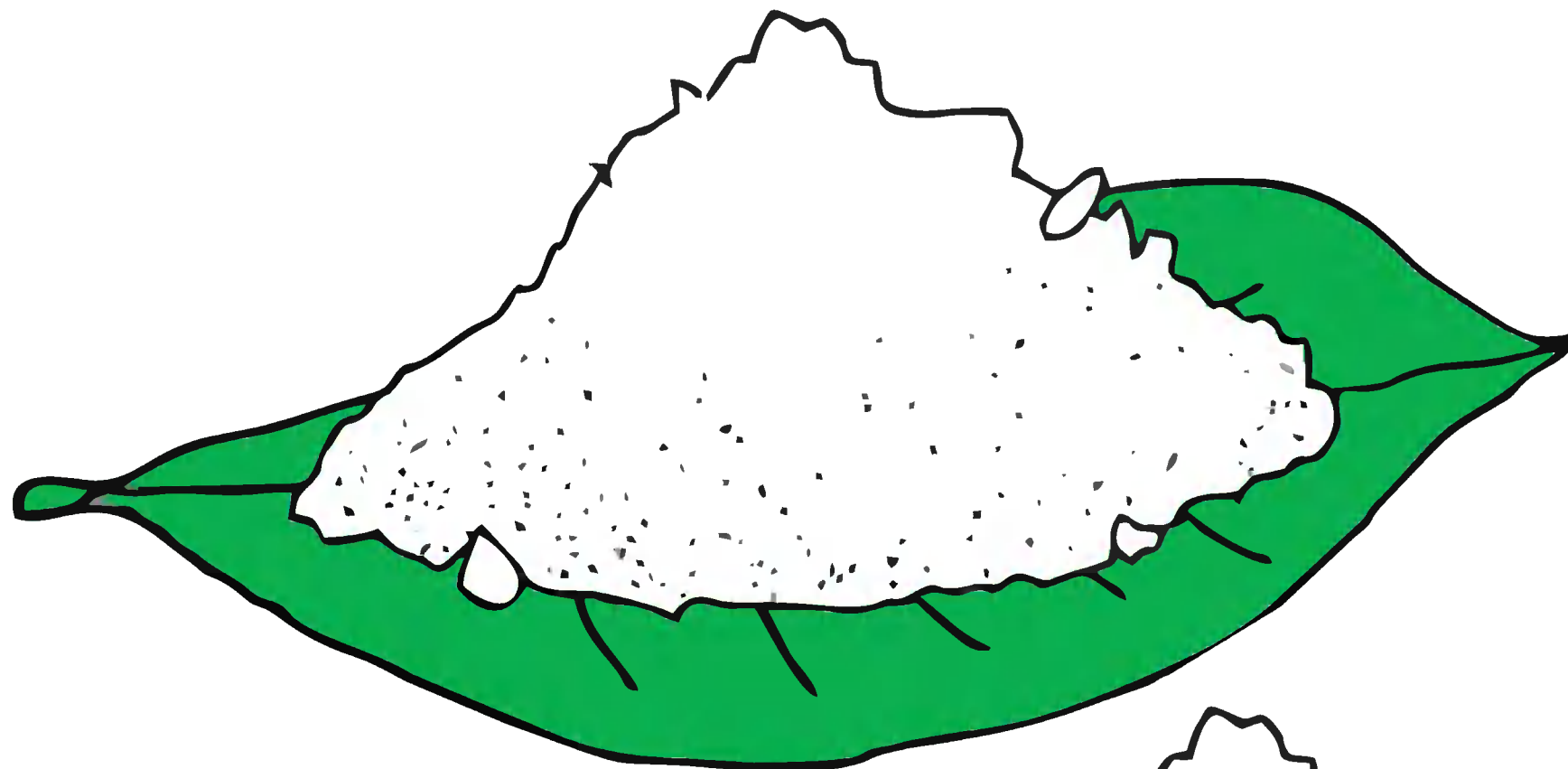

Winia naarka:

Pushan nuwe yakatiaumatmau

Pushan nuwe yakatai:

- Juunt ainiau yainkat tusaram pushan akairam unuimiatirmin matsartaram.
- Emkar aujmatji uchiji tante najanar kemsar warin umiktaij nu.
- Arantukmi iniu tsaniakmauri takakmak pujau.
- Tura nunianka uchi warinchun najaniniawai nuwejai nii nekamurin, nuniasha nakuminiawai nii uwejen, nii nanchikin, nii nawen nuniasha chikich ainiaun.
- Takakmati kiraknum warinchun najaniniawai pushanjai.
- Uwejai pachimrar pushanjai yakainia wai.

**Aujmatmau nakumkamuri jisam nekata tura nunia intramu aikta yasakamuji (x)
shait tsentsakam aujmatmaunumia antukmaurumia nunia.**

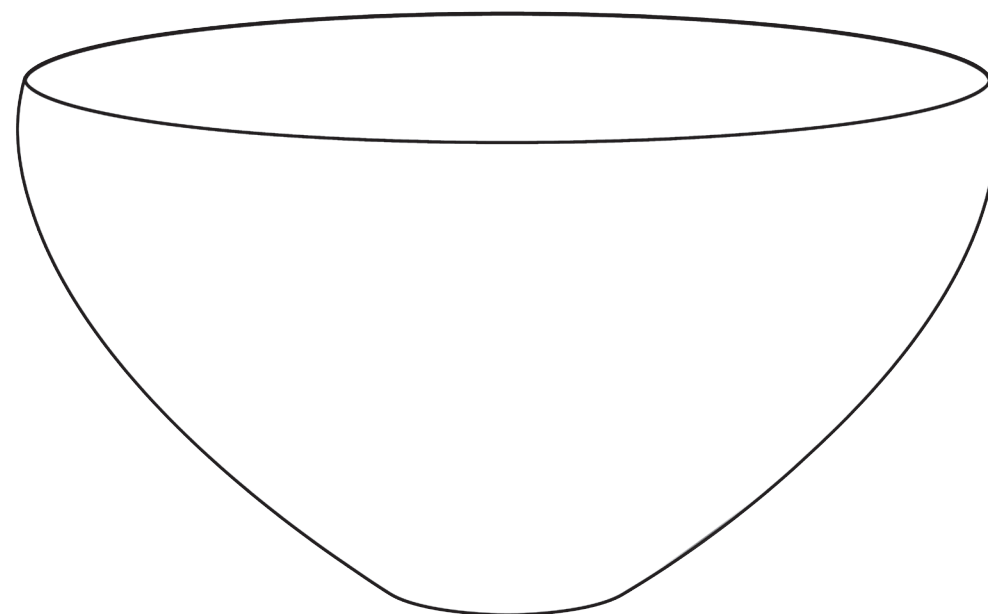
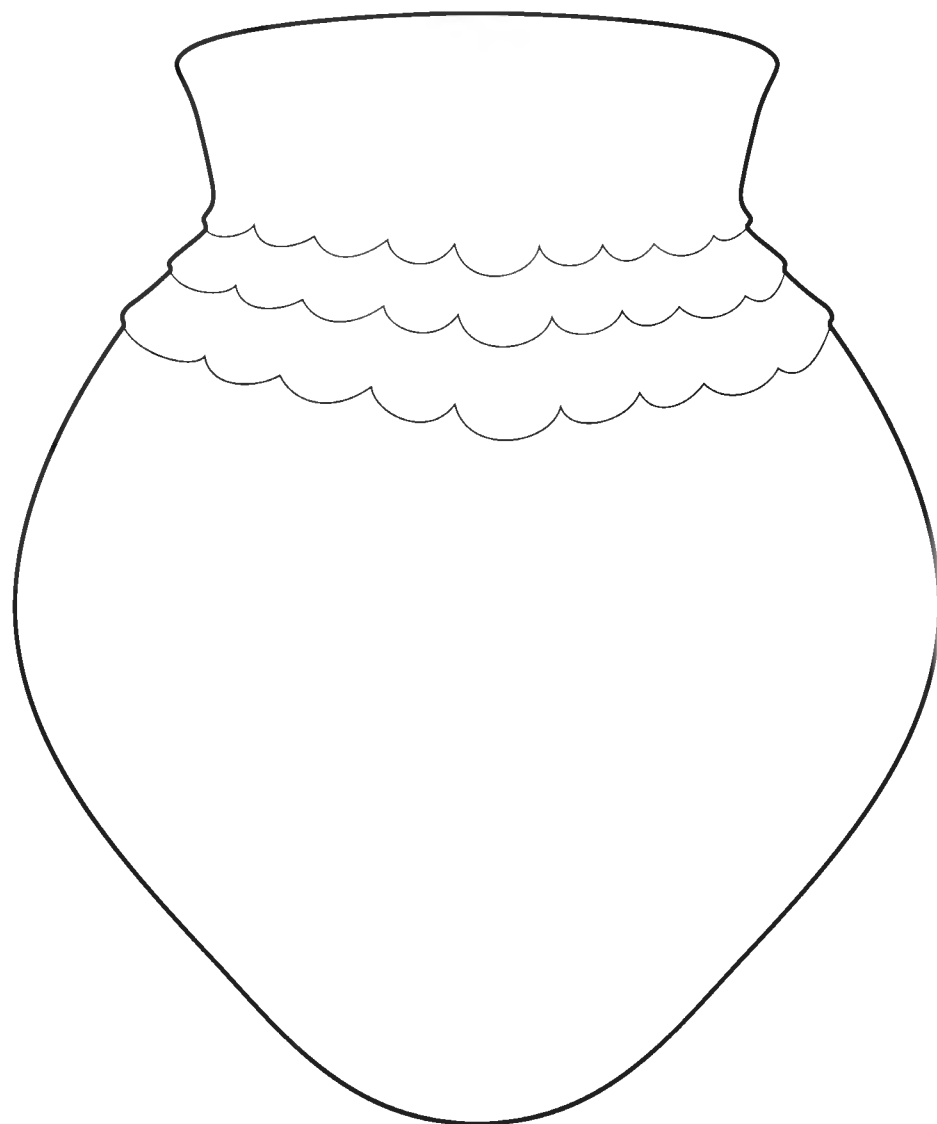

Winia naarka:

Nuweji itior najantainki nuna nintiminiawai

Nukuchin irariniawai warinchu nuwejisha itior najantainki nuna iniasartas.

Eemtik unuikiartin nukuchjiainkia chichasuitiai.

Nunianka nukuchi jeen jear nukuch wari tawa nunaka arantiniawai nuniasha chikicha jeen irainiau asar warinchun arantiniawai.

Nukuch nuweji najantan unuiniawai kiraka nuken pushanjai.

Yakarta nuweji najanamu.



		
--	--	--

Winia naarka:

Winia weuru nuweji warinchu najanar takatiri

Iniu weuri pachisar aujmattsami:

- Kichik kichik uchi jinkiar nii weurin pachisar aujmatiniawai, unuikiartin iniu apari, iniu nukuri nunia ii weuri nakumji.
- Nuniasha aitkasrik nuweji warinchu najanamu ainia nu uchi sawaji ami weuram itiuur juna takawearma nuu turataram tusar.
- Takakmati kirakan jisar nii weuri ainiaun nekainiawai tura kichik kichik warinchu nuweji najanau stiker tutainium nujatinia nuu uchi jiisar suwaji.

**Nii weuri ainiaun nekainiawai tura warinchu nuweji najanmau ainia nu
jiisam susata.**

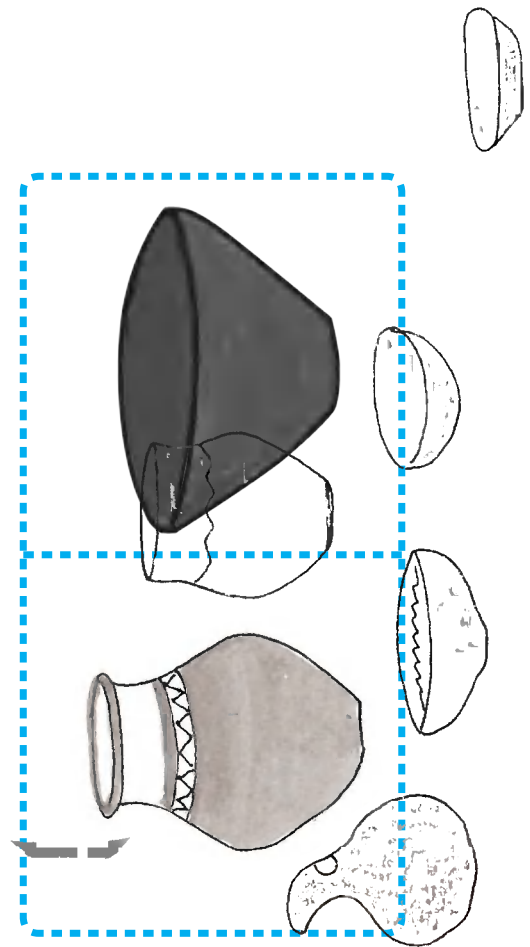
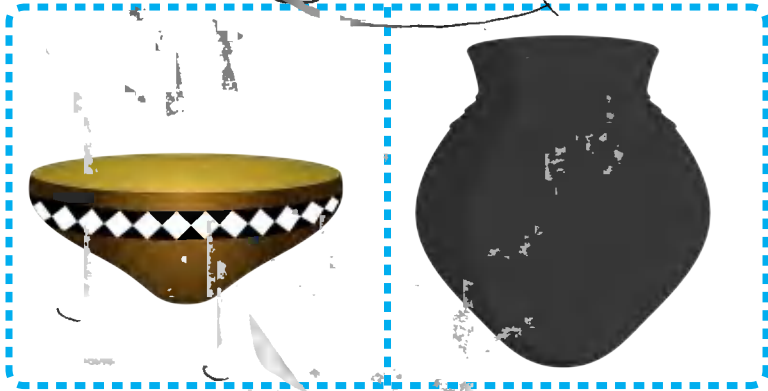
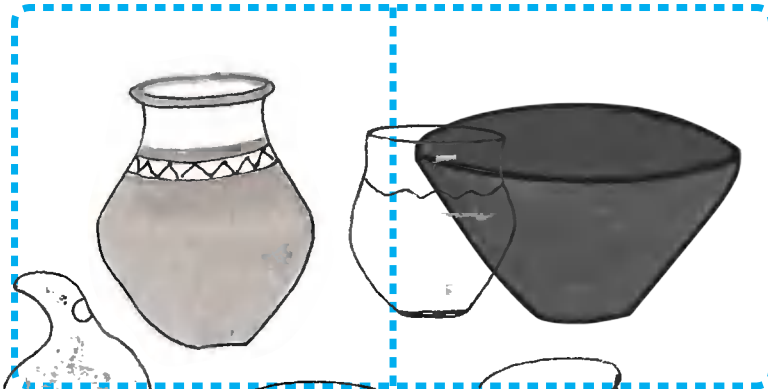
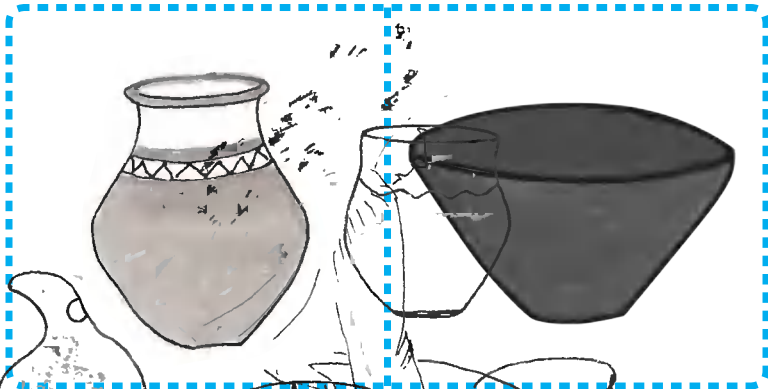
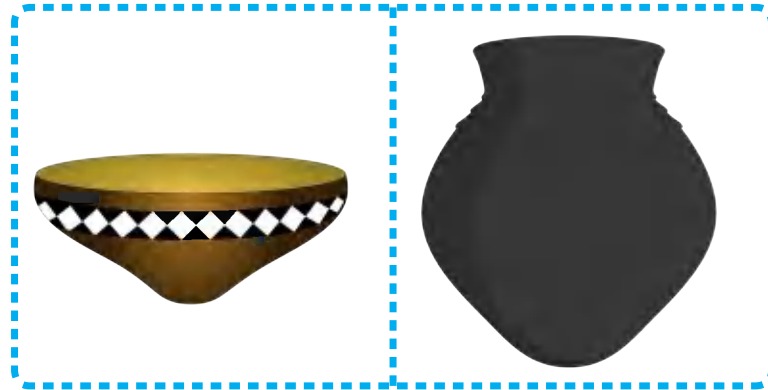

Winia naarka:

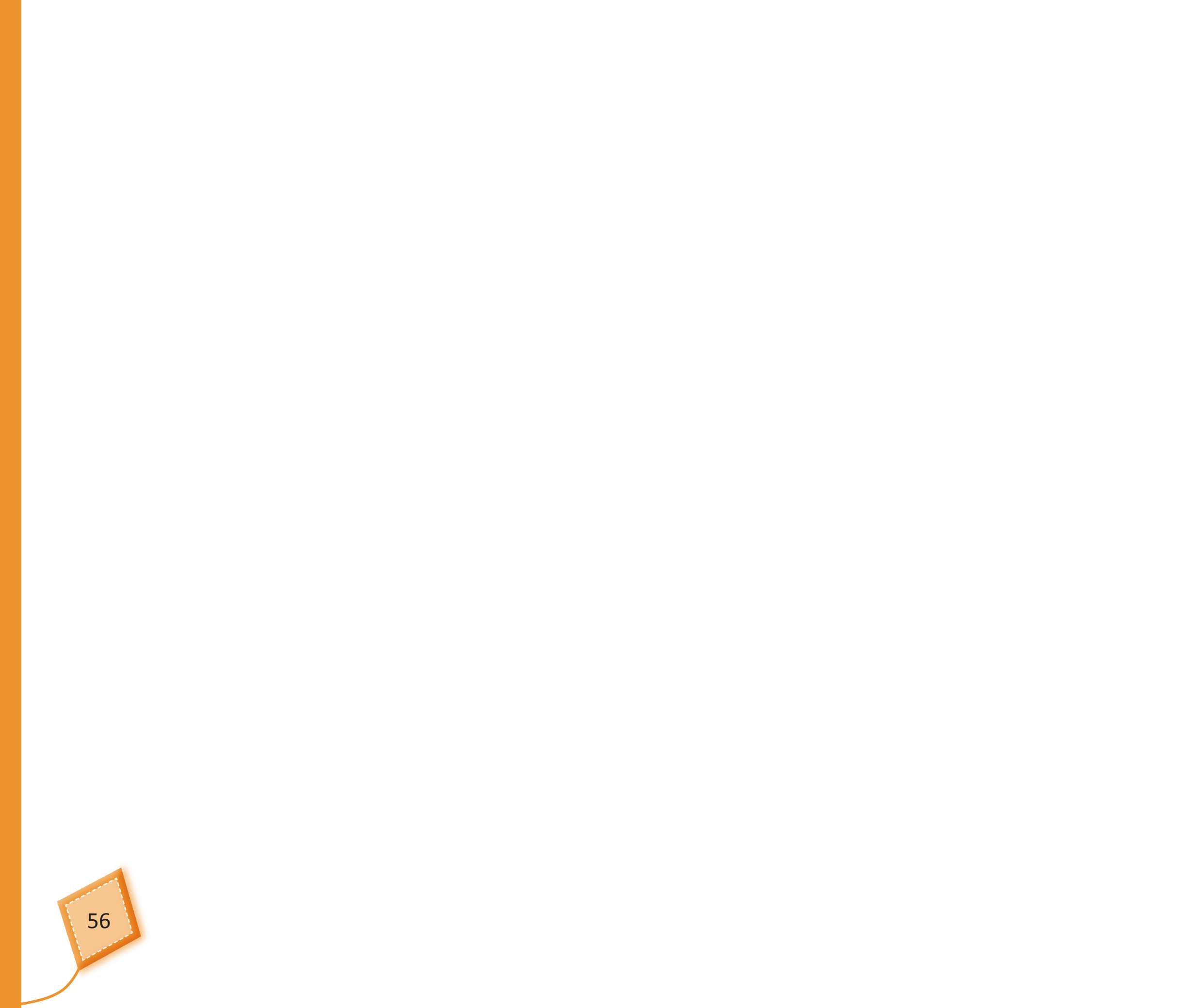

56



Winia naarka:

Kichik tarimiat aints ainiau nuweji warinchi najantairi

Iniur nuweji warinchi najantairi ainiau jiji.

Tura nuniasha uchi ainiau chikich tarimiat aints ainiau warinchi nuweji najanamu aini nuna achikar jiniawai.

Nuniasha chikich tarimiat aints ainiau nuweji warinchi nakumkamu.

Tuup kiraknum pujuinia nu jiji:

- ¿Tuwa ainiawa ii nuweji najantairisha?
- ¿Tuwa inu matsatkamurin najanchatisha ainiawa?

Takakmati kiraknum wainkatatji kirak charurmanum nuweji warinchi nakumkamu ainiau. Tura nunianka nunaji nakurustatji metek.

Ii warinchi nuweji takati ainiau kirakchiniam pujuinia nu patkam jista chikich tarimiat aints nuweji warinchi najankamu aini nujai turaram nakurustaram nujai.



Winia naarka:

Junis ati tamau

Jintinkratatin ame takasmaurumnia paan iniakmasta ame wakerukmaurum,
nuniasha itiur ii pujutri kajinmattsuk unuimiartinki tamau unimiartinki tamau
unuimiarmame nuu paan awajsata.

**li pujutri kajinmatsuk unuimiartiniuitji tusar aarmaji nuu paan
iniakmasan nakumkam yakarta tura nunia charurta.**





**Aja takamu
takastin**



Chichia shiniawai
etsaa tsapuantai
kintia jeaji
tusa warawarat
tsawawai, chichia
shiniatsui yummi
jitiurtas tee
tsawamtai.

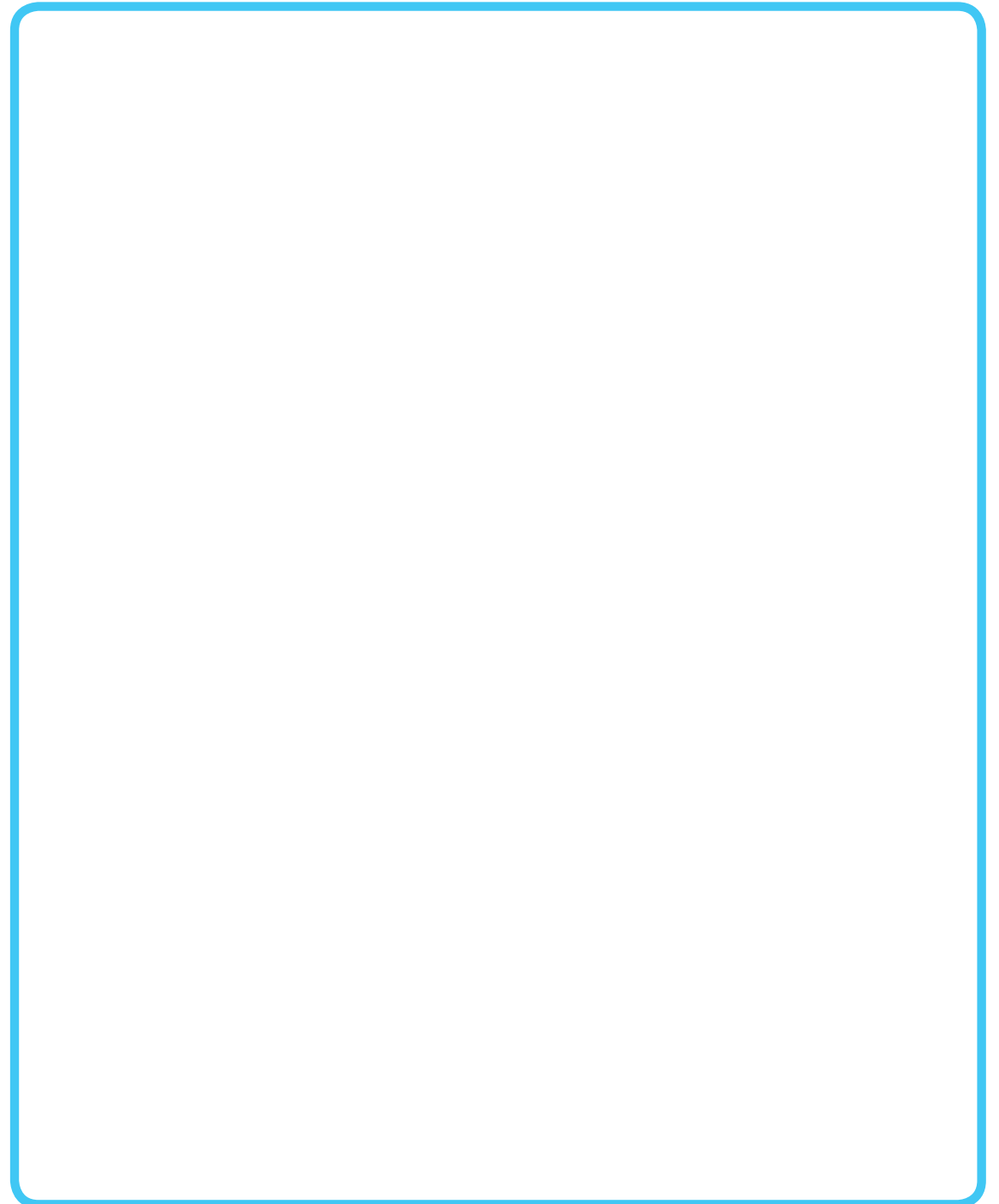

Chiachia

Chicham wake mesemar armau aujsata, turam uchi ainiausha wakekrum aujsataram titia.

Uchi iniasta:

- ¿Wari kintiatia chiachias shininia?
- ¿Itiur shininia?

Juunt werim iniasta warunkan chiachias shininia tusam, nuniash wari takatnat takaush armayi kintia penker tsawamtissha.

Unuimiatiniam waketkir aujmattsatatji, ii aparisha kintia penker tsawamtisha ajan takassartasha inintimsarsha tsawau armasha.

Takakmati papi susata nunia papi charurmauchiji.

Takakmasta: iniannamunam akankarnakumkamujai takasta.

Chicham wake mesamer, mukejai nuimiarmauu chichawai nunia, nakunkamu, charurmaun ayawai, chichia kintia penker tsawawai tusa etserniun.

¿Nakunkata tatatuash
warukuyayi?

¿Nakunkata yumaish
tatatuash warukuitia?



A large, empty rectangular box with a light blue border, intended for a drawing or response to the first question.

A large, empty rectangular box with a light blue border, intended for a drawing or response to the second question.

Tatatua ujmatsumu

Nuniankaa uchi ujmatsumu iniakminiawai wakerakmeke taksha wakekim ujakta.

Uchiji umista tatatuan pachisar ujmatssarat tusam. Takakmati papi susata. (Itiur tatatua nuwan anankawariawak nuu iniakmasmin amatikia iniakmastaram).

Kichik juunt jeent irarsar tatatua ujmatsumu ujakkak tusar antukarmi.

Nakumkata tatatuash warukuyayi.



Winia naarka:

Nunkasha warukuk ainia

Uchi nunkan kichik kichik achikar mejenawai tura wari nunkaki tusar nekainiawai, uchikia jirinkiatamu artiniuitiai.

Mash umisaramti jiiri atitiata.

Unuimiatnum mash uchi ainiau niish, niish nunkan juwiniawai ajisar turar nunianka uchi nuwachiji jiichirin jinkiatawar miaji tata tiar ininrawai, ¿warim tusar?

Turam nunianka titia takasar mejeasar nekawarat warin enketa nuna.

Umisar nekainiawai jiirin uchi atiawar.

Iniaktusta mash uchi nuimiatnum pujuinianu nunca pachimri tura ujakta nunca niish, niish jaisha, wari itiurtayi un.

Shuwin shiram nunkaitia nuni arakmatayi, pisu nunkanmaka paat, shaa, aratayi, tura takum nunkanmaka warinsha arashtayi antsa nuwejinkia pininkian najanin armayi.

Takakmati papi susata nunca niish, niish ainiun nunia nujtaiji.

Aujmattsata waruku nunkak penker ainia, paantam, paat, mama inchi arafi ainia nuu.



Winia naarka:

Aja meamu

Apach ujatmamti aja takat unuimiarmarmena nuu aujmattsataram.

Aneakrumek apach ujatmakmarume nuu: aja meamu, erekar ajamu, eper kemamu, eper japmau. Pachis ujatmarimarmena nuna.

Ajan meenau jitiaram, tura atumi apari ayu tamatinkia atumsha meetaram.

Jistaram warin aja takamunam iruna nuu

- ¿Warintimia untsurisha ainia?
- ¿Warimpia jumchik ainia?
- Unuimiatiniam waketkir aujmattsami wainkamjinia nuu.
- ¿Numi untsurin aarma?
- ¿Jumchikik numi wajarma?

Takakmati papi susata, nekawar warin timia untsuri ama nuna tantekarti.

**Nekainiawai warin ajanam warinchi japkatin ainia nuna (kemartin)
numiuma, nuka, naek.**

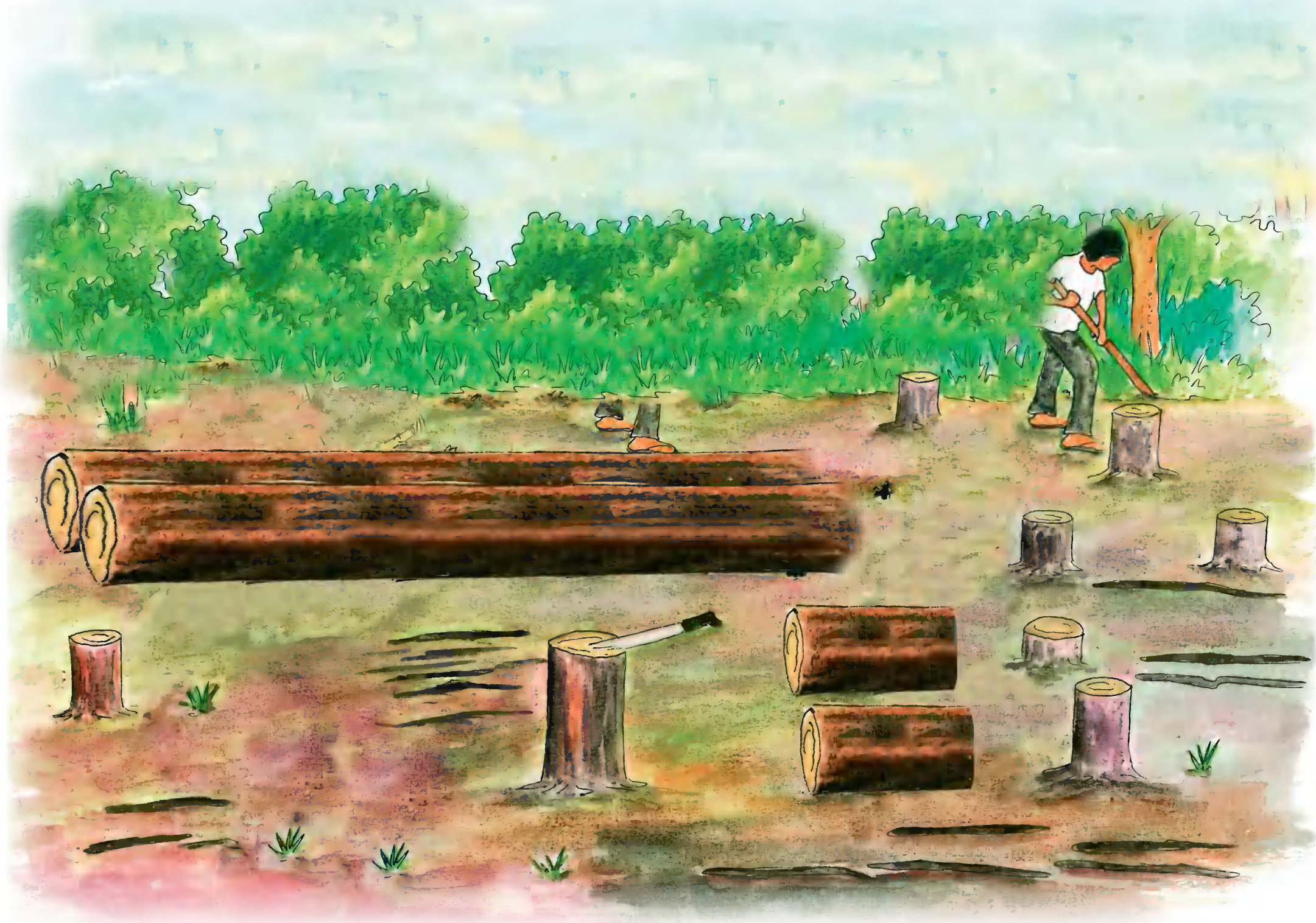

Winia naarka:

Erekrari ajamu

Chichasta uchiji itiura juncha ajan takainiaksha erekrarincha ajainia arak arakmami tusarsha. Unuimiatinmaya jinkiram junikiari yachintiuk yachintuk (4) uchi ainiu. Yachintiuk junikiaru numi pachim susarta nunia kichik chuu muke tiupiwach.

Uchi numi ainiaun nunkanam tuksataram titia tura nakurustaram numi ajaji tusaram.

Kichik kichik uchi ainiau numin ajajai tiar nekapsartiniuitiai.

Tura yamaikia seata tuu numia timia asarmai tura turam jista chikich numijiai patkam. Tuwa pe sarmaitia timi.

Nuniasha chikich warinchusha saram ainiau susamniawitme sarmarin nekapmawar nunia patkar jisarat tusam.

Takakmati papi susata numin sarma nakumkar yakrarat timi.

Erekar ajamunan nume saram jinkau tura sutarach ainiu nekainiawai.

Takatan nekapmau



Jempeka yachuikia aintsauyayi
takakmin nakichu kichik kintiaji ajanka
nankamasha mash amu, turaun nuwa
jiamach suruitia tamaitiat umirkarchau
turamunam nianka jempetsets najanaru.

Nakumkata sempe:

Jempe Takatan nekapmau

Juunjai chichawai uchin ujakat aja takaitiasrisha warin itiurtayi eperkiamarinsha yachik ipiam katascha chichayi aymattsata.

Jempetselska nujintri takarzanka pee jumin ipiamniayi nase asamtai ii nukuchrinkia chichainia pee yuminkiartin tiuniu armayi:

- ¿Wari pachisa aujmata?
- ¿Tuwaitia naarisha?
- ¿Yachia pachinkaruitia?
- ¿Hiur yumisha ipiamtayi?

Takakmati papi susata.

Nakumkata yachik ajatakatan nekapkartuaya nu.

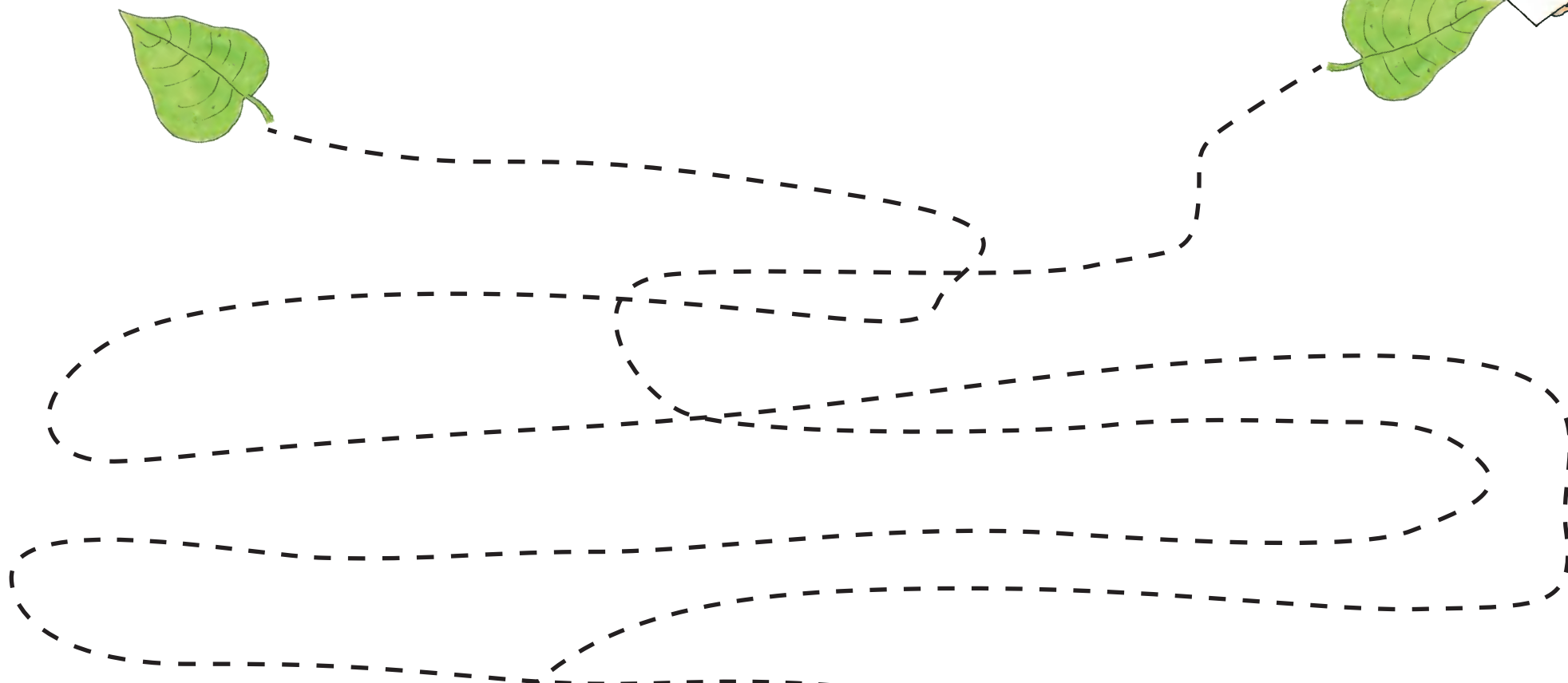

Winia naarka:

Nakuramu nukaji

Nukaji warinchu nakumkar nakuraji, numi ajakmau nuke ainiauji.

Juunt ajan meenak erekram ajakaramtai uchi nukar jukar warinchun weweshan najanawar nakuriniawai.

Unuimiatirin wayawar nakurusmaurin pachisar aujmatiniawai.

Takakmati papi susata, weweshan nakumkar yakarar anujkarat.

Nekainiawai nukaji warinchuwach nakumkar nakurutin.

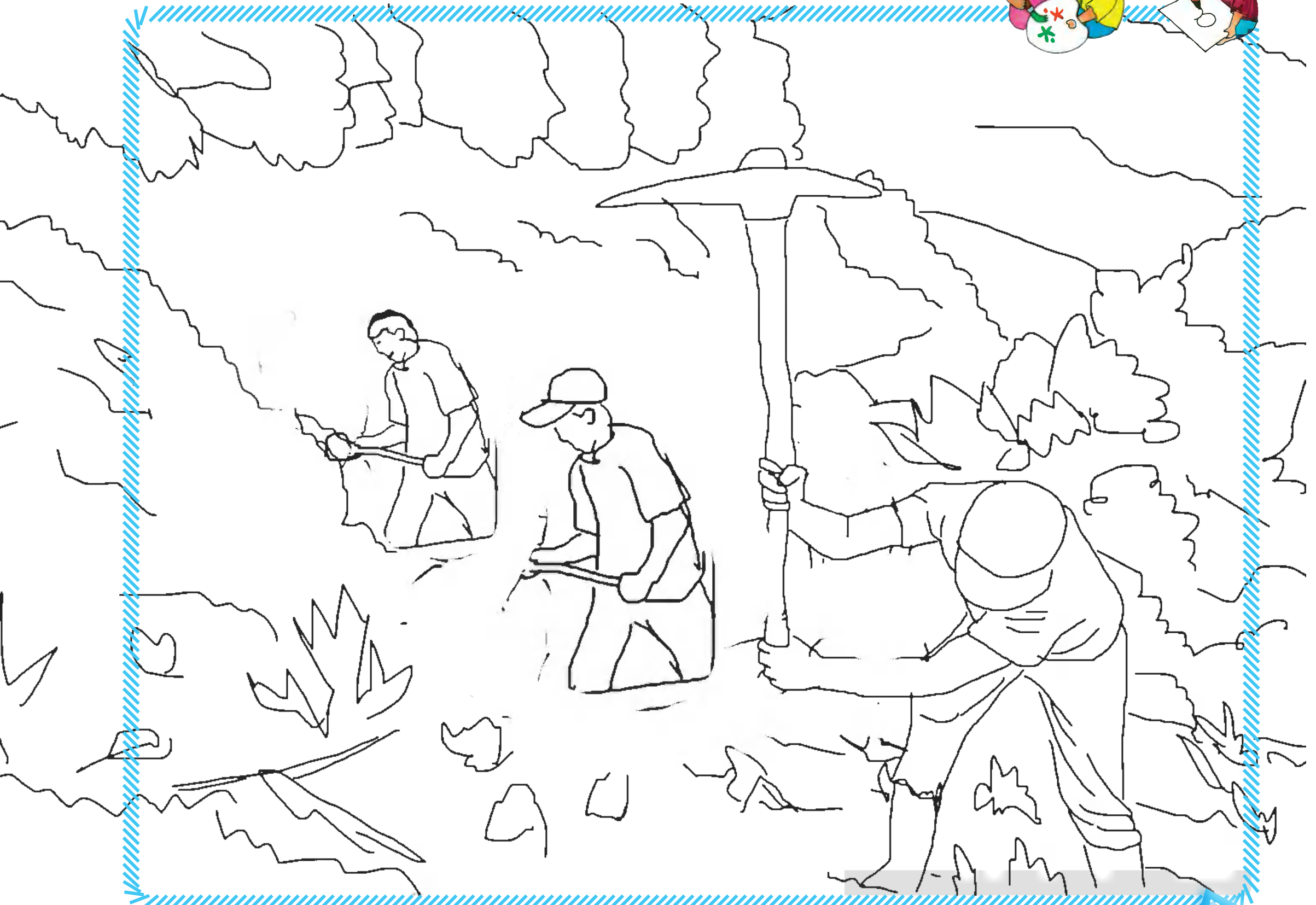

Winia naarka:

Aja ipiakratar takamu

Aja ipiakratar takamu.

Juunt uchiji weme inintrusta ujatmakat jenkarik ipiakratarsha takakmati nuna tura nuniasha warukaria ipiakratarsha takaji nuna ujatmakat tusan.

Nuimiatnum uchiji uminiawai penkeran matsakarmi tusar.

Uchi ainia nakumkamu susata jisarar tusam.

Inintramu:

- ¿Warinia aintscha itiurina?
- ¿Wari takatna takainia ipiaknumsha?
- ¿Waruka nankamakuitia ipiajratatniusha?
- Uchi yachintiuk (4) musach rintin ainiu papi charusmau susata nunia uchi trus (5) musach rintin ainiuka pura yakati susata.

Takakminiak pujuiniamunam uwechiram ipiaknum chupram pik nujkata.

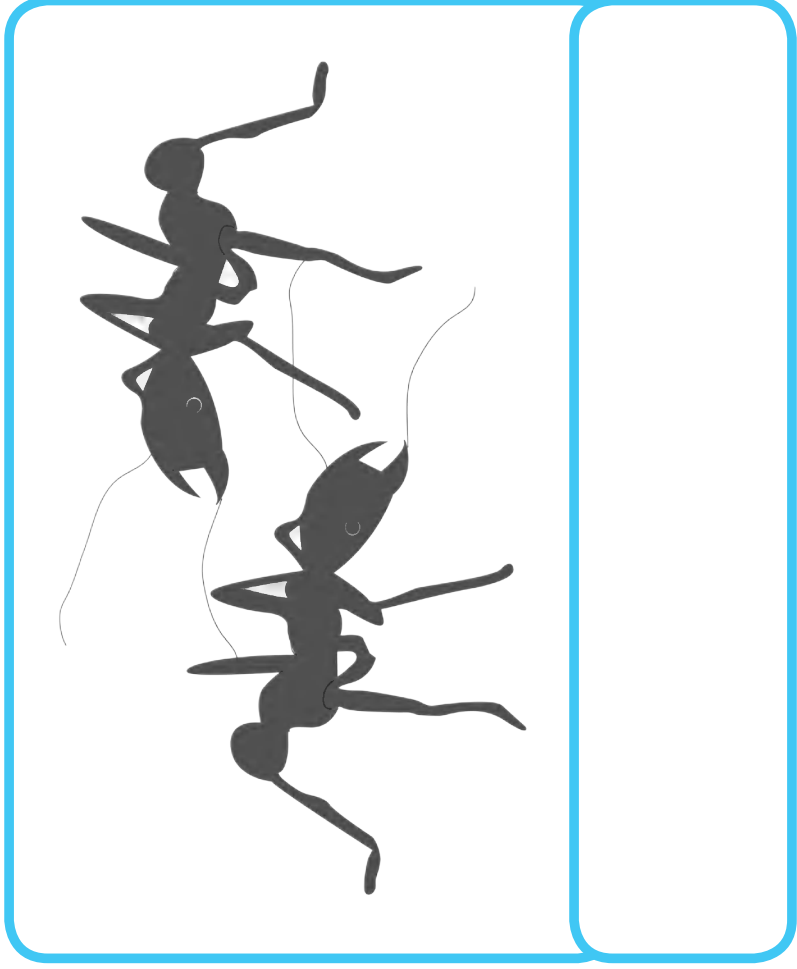
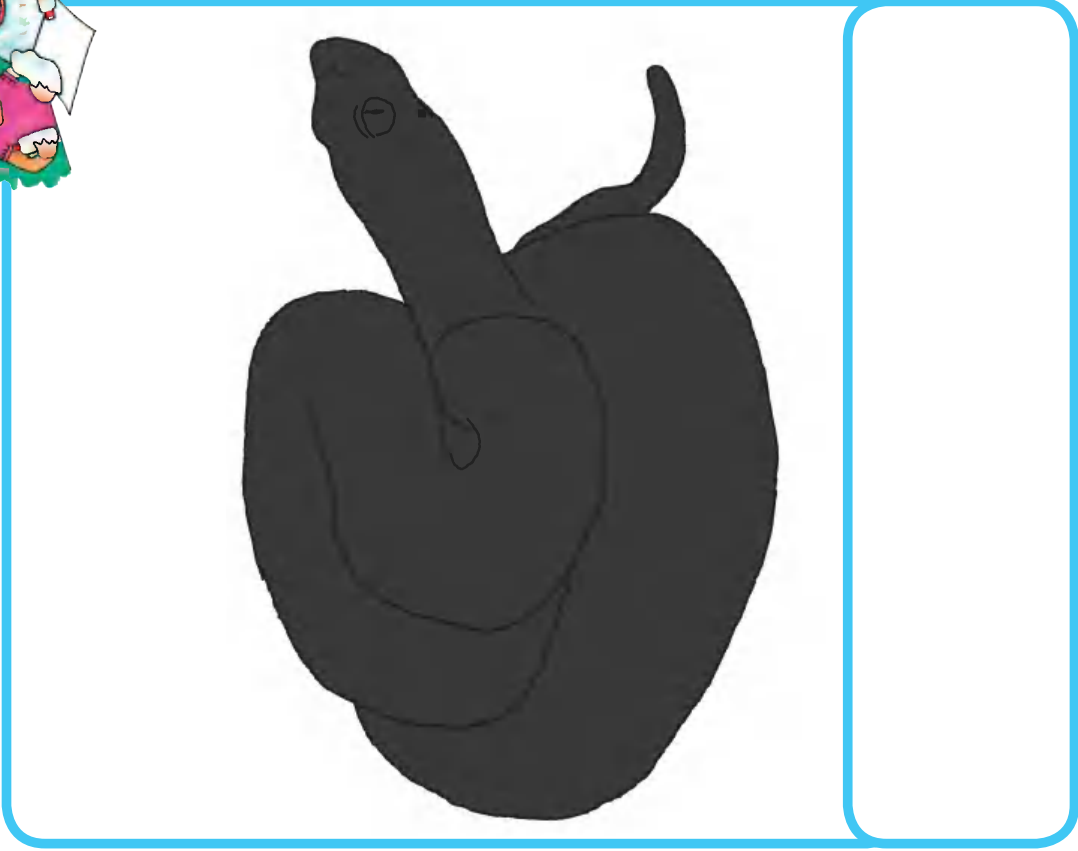
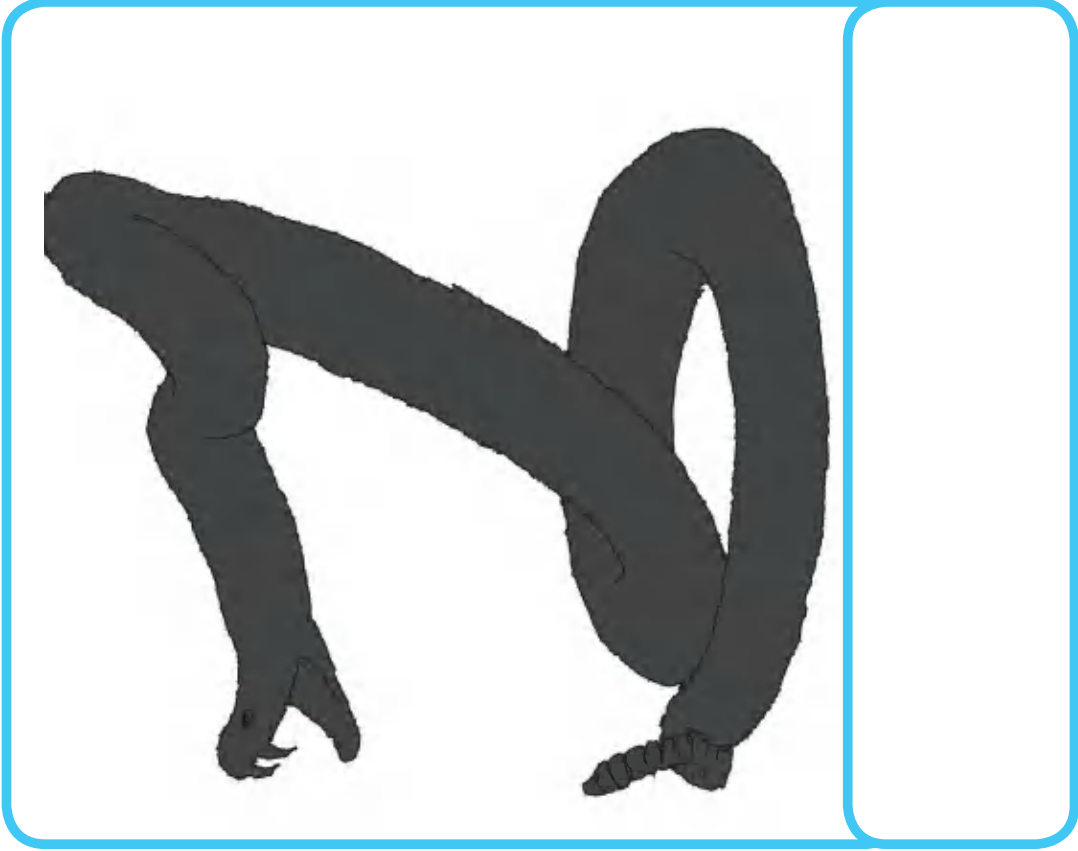

Aja meamunam pahim shamremumpin aimiau

Wapuka ikiam saat amaunum tura nunia ajanmasha inchi aramunam pee tepeyi nunia juun chichainiak ajan wainiak puju tiniu armayi.

Nuikiartin aujmattsamun nakumkamuji iniaktawai jisarar tusa:

- ¿Wari pachisria aujmatai?
- ¿Wari naak pujtusaintai?
- ¿Warukuitia wapusha?
- ¿Yachia ainiawa?
- ¿Tunia pujuyi wapusha?

Aijku weaka ininrawai uchin aujmattsamun pachis.

Nanki ka takashkati ain kasha, ain ñushi (ñuin) akë aka mënioki a mapuxo(maxka) tukaki sinankë, i (in) axbi akë a ka uisokin ain ñu kama akekara,kixun a unamikin ati, a nukë inankë.



Winia naarka:

Mama inchiji patkat aramu

Nunka jista aja takai mama aratniurmeana nu, arantukta amin ujatmakarmana nu.

Chichainiawa nii jismaurin tura uchi ainiusha aintsaran atsereniawai ii weuri arakmamun.

Nuniasha chichainiawai niish, niish arakmati, mama, inchi:

- ¿Wari yurumka wakereniarme?
- ¿Tura waruka wakeriniawa?

Takakmati papiniam itiur inchi mama nakumkamu nujkayi stiker o troquel tuksat tusa.

Mama aramun jiisartas wenawui, tura mama itiur aratniuki nuna antukar arantiniawai chichan umiktin najanamun.

Nuimiatiniam aujmatiniawai mama aramu wainkamurin tura aintsan uchi nii mama itiur aratniuki nuu nekamurin aujmatiniawai.

Aintsaran nekainiawai mama tura inchi itiur aratniuki nuna:

¿Wari yurumka shiram yuwatasam wakeriniam, waruka?

Takakmati kiraknum wakan mama tura inchi aramu nakumramu stikernum pujuinia nuu jiisam tunin nujram nuni nujrata.

Warutam pachim mamak tura warutam pachim inchik ainia nuna nekainiawai, tura nunia mama, nunia inchi warukuki nuna jisar yakainiawai.



Shaachi amin yuwakun
shirman tsakajai
nuimiatrunsha shirman weaja.

Shaachi amin yuwakun
shirman tsakajai
nuimiatrunsha shirman weaja.



Shaa arakmamu

Nuikiartin enentan jjawai arakmatin pachis.

Aarta anent shaachi amin yuwakun shirman tsakajai nuimiatrunsha shirman weaja.

Turam:

- ¿Wari aarakmatia takakji?
- ¿Warauku ainia?
- ¿Tuwa pee miaai untsuri arakmatayi?
- ¿Tuwa jumchiksha arakmatayi?

Takakmati papiniam nekata tuwa untsurisha arakmatayi tura tuwa tee untsurichusha arakmatayi.

**Apatkam jista chikich mikjai tura aintsan iniu mikjaisha apatkam jista.
Nakumkata enen enentramu, tura wari pachisa aujmata nuu.**



A large, empty rounded rectangular box with a blue border, intended for writing or drawing.

A large, empty rounded rectangular box with a blue border, intended for writing or drawing.

A large, empty rounded rectangular box with a blue border, intended for writing or drawing.

Winia naarka:

Aja takamu

Aujmatitiniawai uchi iruntrar apach aja takatin pachis aujmattsamun.

Wainkiar aujmatiniawai apach ajakmaum itiu ajatinki: nuni ajamu eper juwamu eper akamu.

Nii nintimmauram iniasta. ¿Emkasar erekran ajakartascha wari itiuin arma?

¿Erekran mash umisarsha wari itiuin arma?

Nakumratin ainiu:

- ¿Aja takamu?
- ¿Yumiri ajamu?
- ¿Eper akamu?
- ¿Eper juwamu?

Nunianka mash umismaun maka mama kunchi aramu.

Takak kiraknum nakumkamu susata charak troquelnun nujkattimi.

Aja nakumkata tura anujrata tunin anujkamniwi nuu jiisam. Tura nunia ami tsaniakmaurum itiu aja takatinki nuu ujakta.



Winia naarka:

Junis ati tamau

Jintinkratatin ame takasmaurumnia paan iniakmasta ame wakerukmaurum,
nuniasha itiur ii pujutri kajinmattsuk unuimiartinki tamau unimiartinki tamau
unuimiarmame nuu paan awajsata.

**li pujutri kajinmatsuk unuimiartiniuitji tusar aarmaji nuu paan
iniakmasan nakumkam yakarta tura nunia charurta.**





¿Yachia entsa
nijiamuncha
chichamrinia?



Winia naarka:

¿Yachia entsa nijiamuncha chichamrinia?

Unuimiatirmin waketkiram apach aujmattsama nuu atumsha aujmattsataram unuimiatirmin pujusrum (uchi yachia anujrartiniuitiari juu tunin puju ainia nuna jisar.

(Nakunikata entsanam marunch namakjai pujuiniau).

- ¿Warukua ayi maruncha?
- ¿Warukua ayi kapamniurisha?
- ¿Tunia pujuyi?
- ¿Warinia maruncha yuyi?
- ¿Warutam apu ayi?

**Marunchkia entsan nijawartinnaka nekawai turayat namaknaka ujachayi,
charukam nuu tunia marunch pujuwa nuni nujkata.**

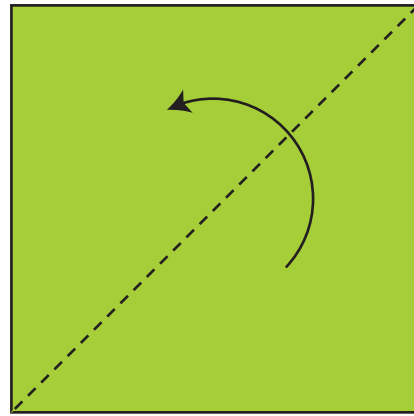
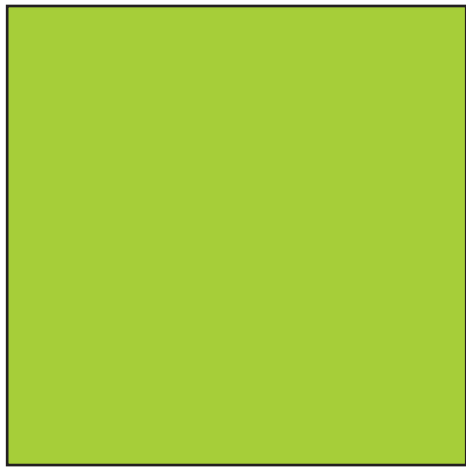

1

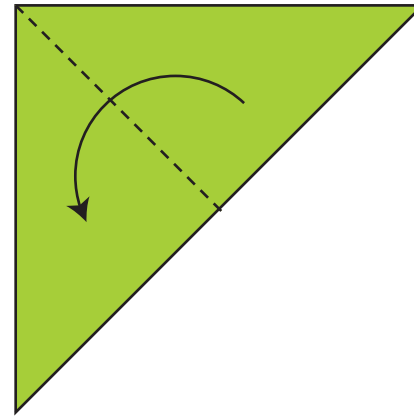

2

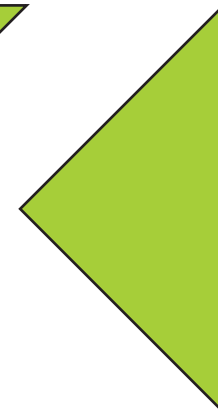

3

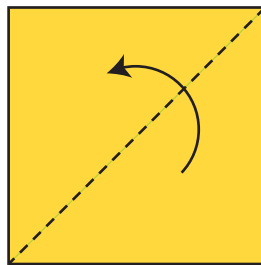
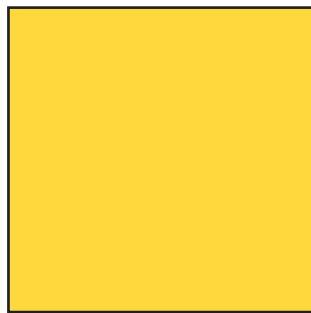

4

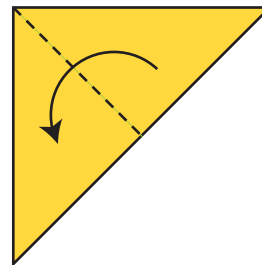

5



6

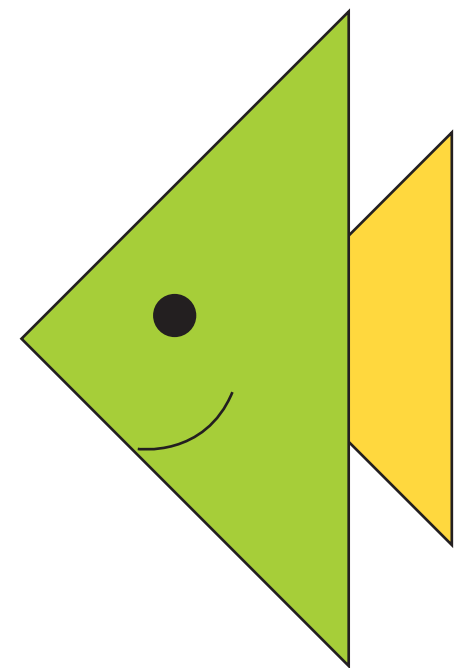

Winia naarka:

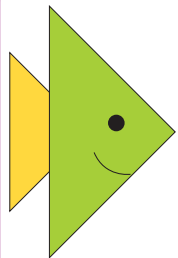

Winia naarka:

Namak juukar matsarar nekaji

Uchi namak wawaji nakumkamuji nakuriniawai.

Namakan juuntrin juukar penkaji tiniawai, nunia chichirin juukar yunkuniniawai, tura chikichnaka weeminiawai.

Nuniasha uchi nakurusar miniuitiai namakaitji tusar namakan naarin pujmamsar, nuniasha juuniniawai nii weuk weuk.

Juu arminiuitiai:

Sapapak sapapak

Katichik katichik

Kapawik kapawik

Namak penkatin tusar juukmau.

Takakmati kirak susata nunia namak nakumramu stikernum pajuinia nuu turam namakchin jisar juukarat tusam. Aarta kichik kichik namaka naari.

Namak metek ainiau juukam chankinum chumpiata nekapmaram, tura nunia shait shait tsentsaram namak nekapmarta.

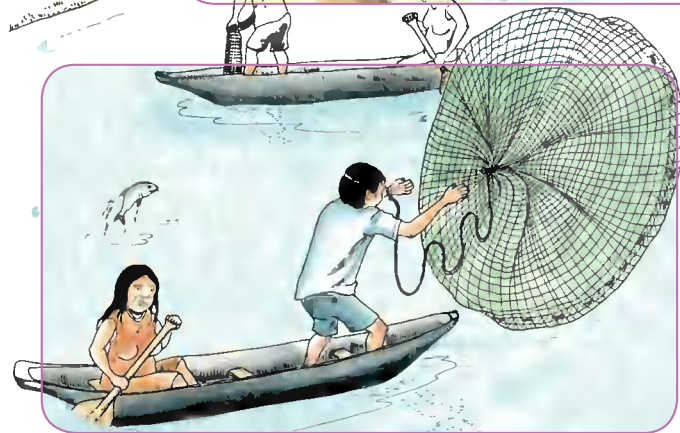
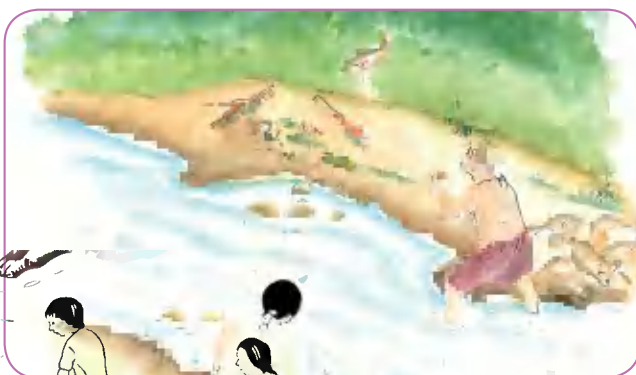

Winia naarka:

Entsasha ituir nijiatinki nu

Namak ituir achiktin tusar nakumramun jiniawai, jisar nekainiawai namak ituir achiktinki nuna.

Namak masuji nijiamu.

Namak timuji nijiamu.

Namak tsauji wakemmau.

Namak tankirpishjai achiamu.

Namak nankiji ijiuamu.

Nuikiartin tawai: aintsun uchishay niniu nakurutirin kichik, kichik takaimawai:

¿Uchiniusha wari ayi?

¿Warinia namaksha turuachminiutia?

Nakumkata wariija namaksha nijiatayi: mamusnum, entsa kanajinha.

Nakumkamu patkam jista entsa ituir nijiatinki turam nu achimtikrata.



Winia naarka:

Namak ii nunken urunu

Tuksata tsapanam namak kichik, kichik nakumkamua au, kapawi, aikiam, pua sapap, katich. Turanta, uchi jisar narinka naitiurartatui.

Uchi nuikiartiniun tiniawai, turamtai nuikiartin namaka nari aawai chapanam.

Tura nuikiartinjai namaka nari armaum ujiniawai maikikia nuiminiachusar:

- ¿Tuu namaka wakereniame?
- ¿Tura waruka?

Uchiji nakurusta namak nakumkamu yapajiam.

Papi susata uchi nii keramurin namaka naarin ararat.

Namak nish nish nakumramu ainiau jiasam naari kichik kichik apujturta.



Winia naarka:

Namak wakerutir

Tuksata tsapanam pachin namak nakumkamua au najmasmau (1) katich. Kichik aikiam, kichik pua, kichik sapap turam uchi seata etserkat niakmakmakiak.

Kichik, kichik uchi susata, kichik akuj. Tura nunak mash irunsar tsaniakmaurin ujakartatui:
¿Warutmanak Diego takaka? nuna.

Papi susata najanat namakan, niniuk nujkatai entsa nakumkamunam.

Nakumkata entsanam namak pujuiniu.

Kirakjai namak najanata tura nunia chikich nuu itiu najanata timiawa nuu jiisam. Tura nunia iniakmasta shait shait namak ainiau tsentsaram.



Shirmaitiai yunkunamu



¿Wariya tumalditia?

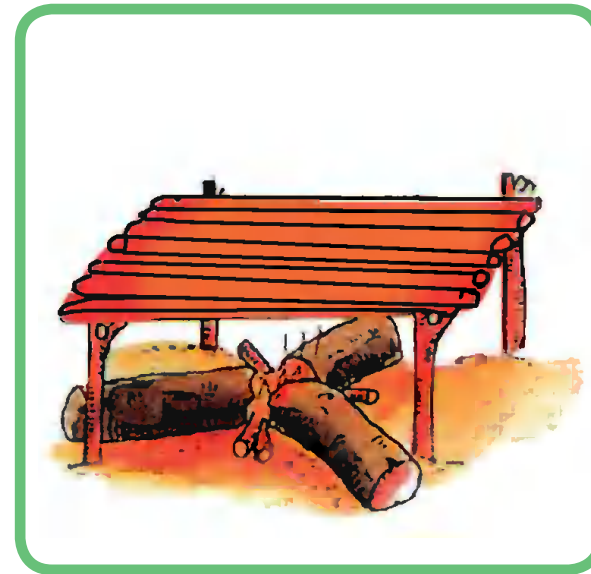
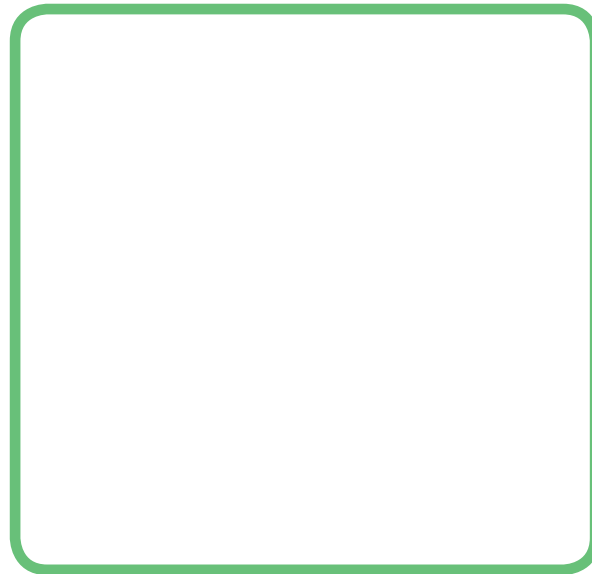
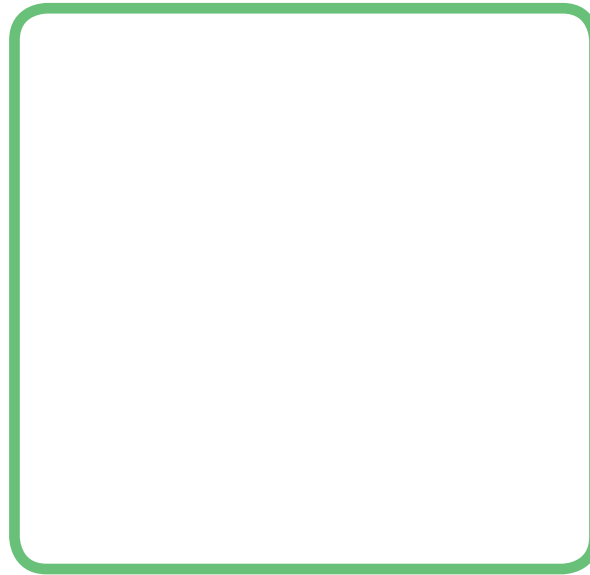

Winia naarka:

Shirmaitiai yunkunamu

Nukuach anuimiatiniam ipiata uchin yunkurak yunkuntan nekapruat tusam.

Nukuch yunkurkan nekapmamti uchikia jiiniawai, wari nukajin yunkuna nuna, nunia warijin pachimiar yunkuna nuna jiiniawai.

Yunkurkan naramti uchikia nakuminiawai itiur nukuach yunkurkan nekapmamki nuna.

Uchi kichik kichik nii nakumkamurin tsaniak maurin ujainiawai antukarat tusa.

Takakmati kirak susata nunia yakati.

Tura nunianka nii uwechirin nijainiawai yunkurak yuwami tusar.

Yuwar umikiar kijminiawai.

**Nukuach yunkurkan yunkunu nakumkamu puja anu uwejchiram pushannum
chupran yakarta. Nunia itiur yunkurkasha yunkunta nuu aujmattsata.**

Shirmaitiai yunkunamu

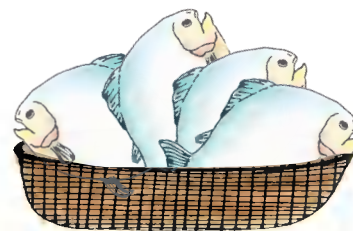
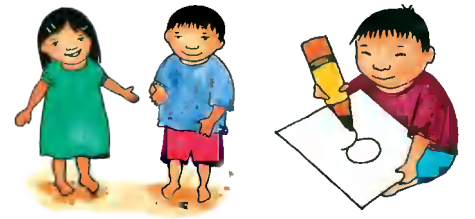

Winia naarka:

Shirmaitiai yunkunamu

Nukuach anuimiatiniam ipiata uchin yunkurak yunkuntan nekapruat tusam.

Nukuch yunkurkan nekapmamti uchikia jiiniawai, wari nukajin yunkuna nuna, nunia warijin pachimiar yunkuna nuna jiiniawai.

Yunkurkan naramti uchikia nakuminiawai itiur nukuach yunkurkan nekapmamki nuna.

Uchi kichik kichik nii nakumkamurin tsaniak maurin ujainiawai antukarat tusa.

Takakmati kirak susata nunia yakati.

Tura nunianka nii uwechirin nijainiawai yunkurak yuwami tusar.

Yawar umikiar kijminiawai.

**Nukuach yunkurkan yunkunu nakumkamu puja anu uwejchiram pushannum
chupran yakarta. Nunia itiur yunkurkasha yunkunta nuu aujmattsata.**



Winia naarka:

Wari namaknak uchi yuwacharmin ainia

Yuwacharmin ainia.

Nukuach ipiata uchi ainiaun nekapruat wari namakak yuchati ainia nuna.

Namak nakumramu iniaktusta turam iniasta wari namaknak yuwacharmin ainia nuna neka warat tusam.

Nuniasha inintrusta chikichnasha wari namaknak yuwacharmin ainia tura nunia tsaniak maurin ujakarti.

Takakmati kirak susata nunia tishi.

Tura nunia ayararti nakurutin, ayararamti inintrusta:

¿Nuna namaka naarisha tuwa ainiawa?

¿Wari namaka tumawa ainiawa? ¿Warinma nish nish ainiawa?

Shiram inintimrata namak itiur yutainki nuu. Nunia aujmatstsata warukan uchikia yuwacharmi niui tura nunia namak yuchati ainiau nakumkata.

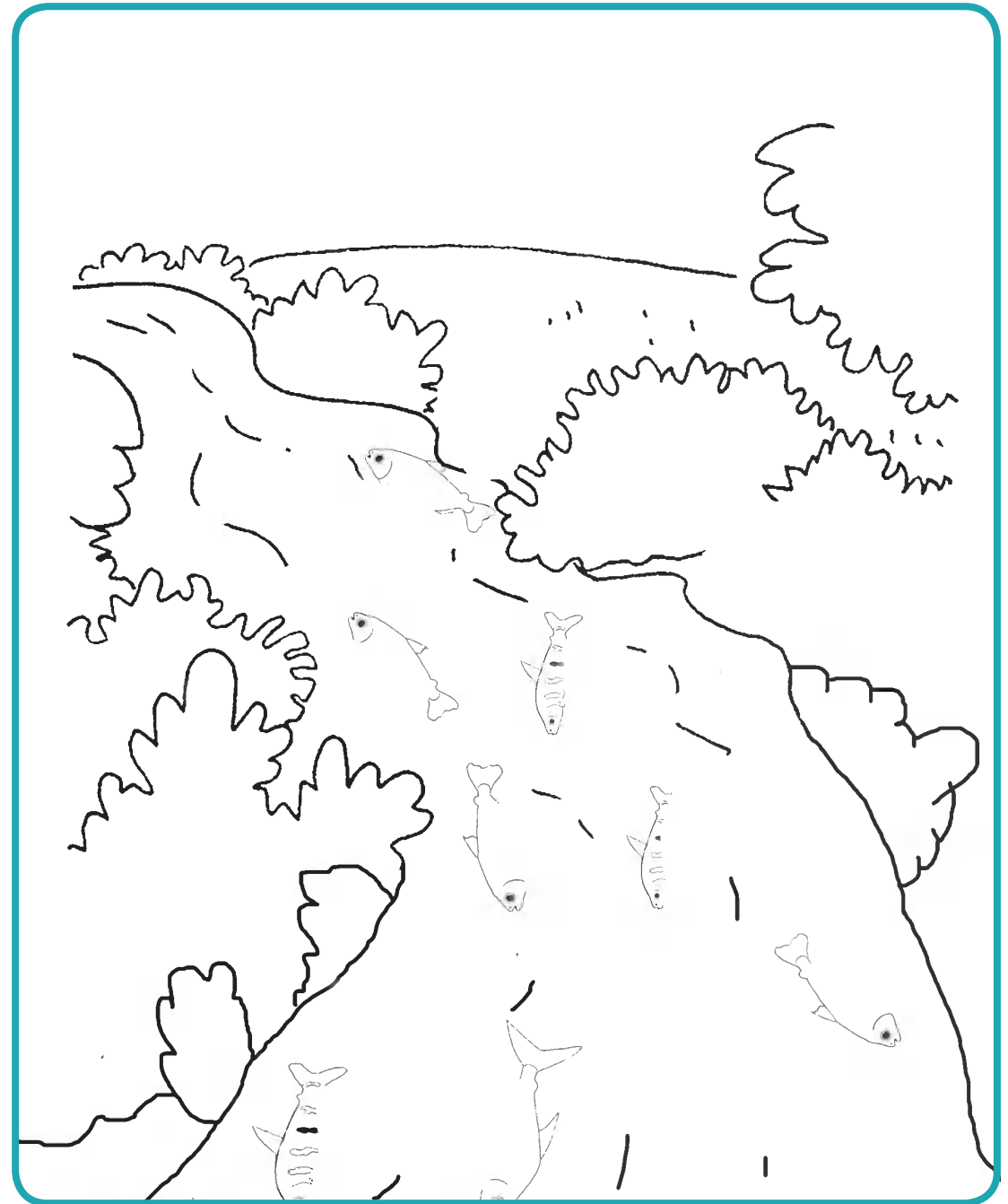
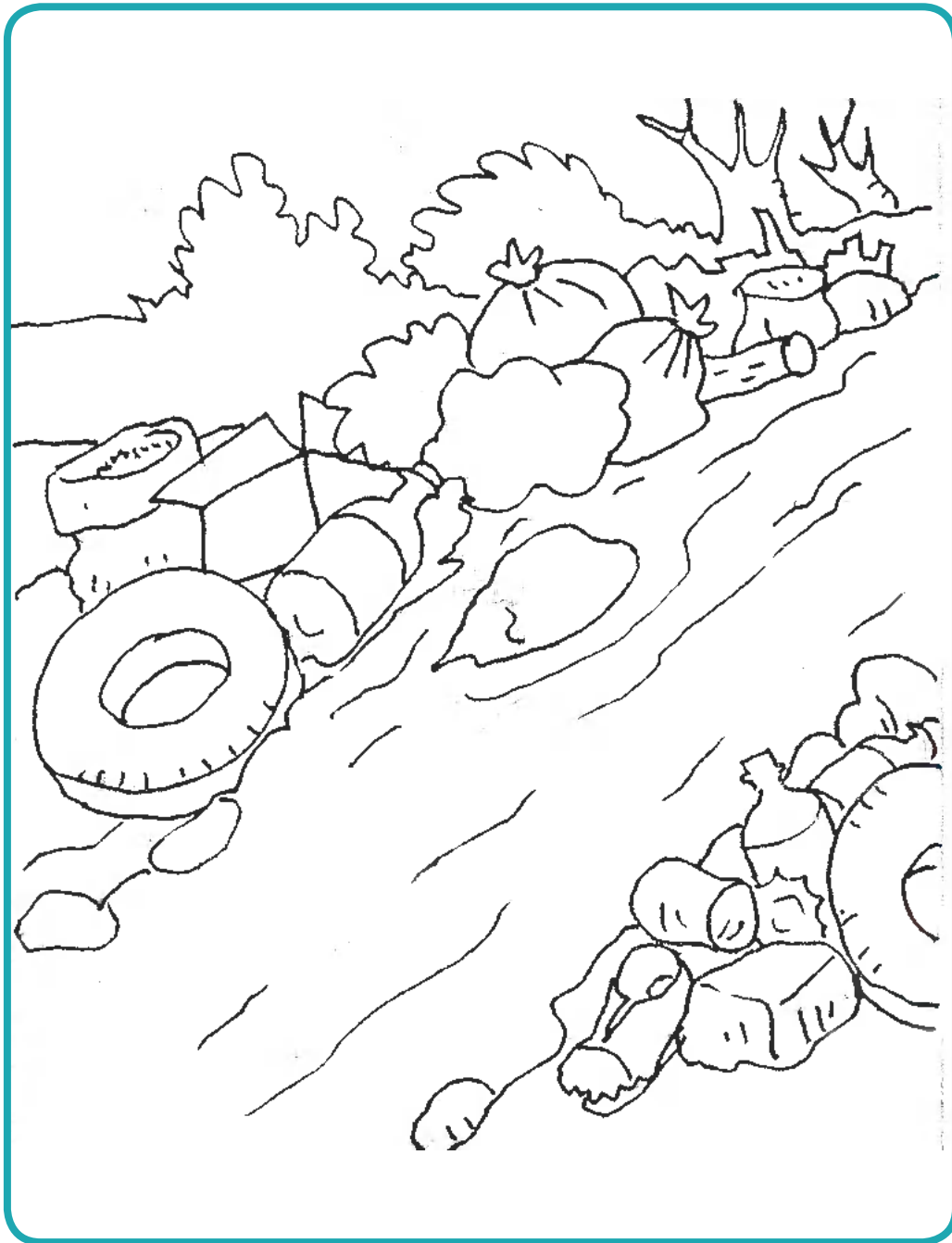

Winia naarka:

Entsa penker

Jijja entsanam nankamau:

- ¿Entsasha itiur pujawa?
- ¿Warukua entsar attimia wakerame?

Shiram, pakui, pachitsuk tsawatjaptai timik wakeram:

- ¿Ainiu amatisha namaksha waruakawaraintiaki?
- ¿Uchi ainiu entsaka penker wainkatji tiniawai?

Papi susata uchi.

Seaji jisaran nakunkamun inintramuji:

- ¿Warukuitia entsasha?
- ¿Yachia pasemantikinia entsansha?
- ¿Itiur awainkatniukitia?

Jistaram papiniam jimiar entsa nakumkamuitiai entsa penker, entsa pakui, uchi aujmatiniawai turar nakumui namak entsa shirmanam pujaum.

Tsaniakmaurum ujakta namaksha entsa pakuiniumsha warukawarminiuk ainia nuu. Tura nunia chikich namakka entsa shirmanam a kupkata.

Panki



Pankinkia entsaram pujuyi namaka nukuri asa,
namakka panki pujamunmaka untsuri pujuy.

¿Panki entsanam
pujantish wari
pachir pujuwa?

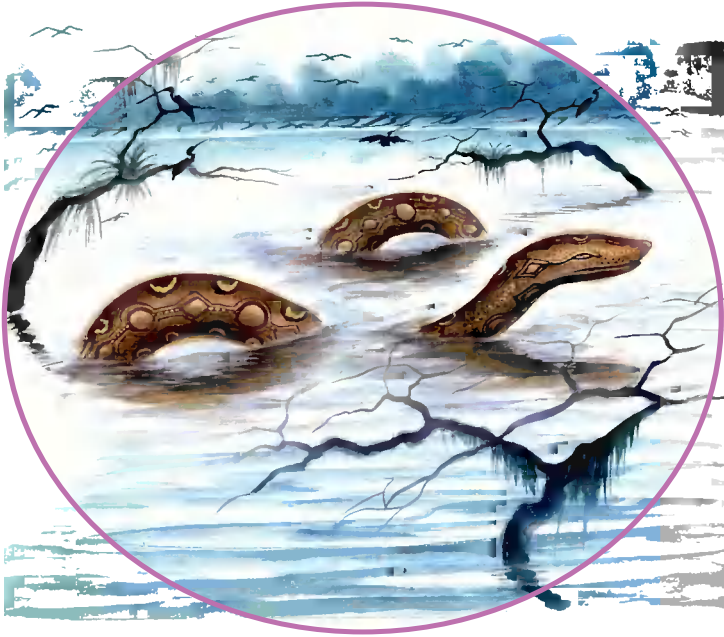

¿Yachia nama knasha wainnia?

Uchiji iruntraram aujmattsataram itiurak pankisha namakjaisha penkersha iruntrasha yujainia. Nuniasha pankinkia nukap aints ainiau uchirin amutiniamka namaknaka emenkartinuitiai tura turaka entsa ayakmaunum ejekatniuitiai nujintrin ejerarat tusa.

Panki aujmattsata

Pankinkia entsanam pujuyi namaka nukuri asa, namakka panki pujamunmaka untsuri pujuy.

Panki aujmattsamu uchiji aujsata. Uchi inintrusta pankisha warukua ayi tusam. Ataksha wakeasmek aujat wakerakmeke ataksha aujsata panki pachisar aujmatmau.

Papi takati susata.

Nakumkata panki entsanam namakjai pujau.

Aujsata nakumkamu jiisam tura nunia nakumkata namak yujau.



Winia naarka:

Kanujai weajai namakan achiktasan

Unuikiartin uchin suwawai trus (5) kanu niish niish ainiaun.

Patkar jiniawai tuwa kanu timia juntai tura tuwa kanu pee tiupchi tusar.

Nunianka unuikiartin tawai kanu jukrum matsartaram tiupchinmaya nankamsam juntnum, tura juntumia nankamsaram tiupchiniam.

Aitkasaram uchisha pekanikiartatui nampuarunmaya nankamsar tiupchiniam tura tiupchinmaya nankamsar juuntnum.

Aitka saram chikich warincha ainiauncha juukar matsarartiniuitiai.

Takakmati papinium unujrartatui kanu itiur natsarmaj nuna, juuntnumia nankamas tiupchirin, tura tiupchirin nankamsar juuntrin.

Nekainiawai tura apatkar jiiniawai warukuk ainia nuna tura nunia kanun anajiniawai tiupchinmaya nankamsar junnum, tura juunnumia nankamsar tiupchiniam.

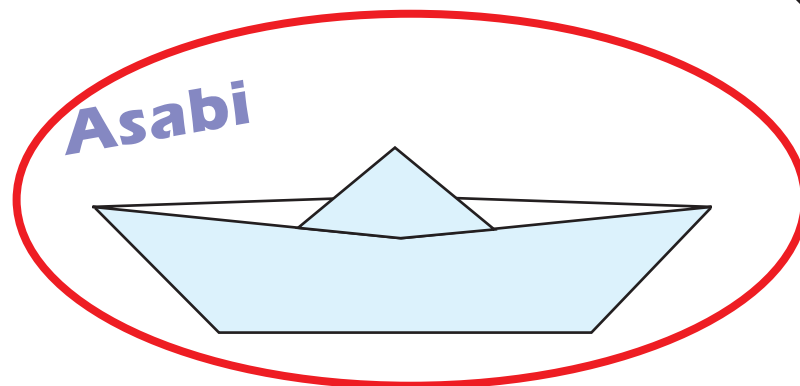
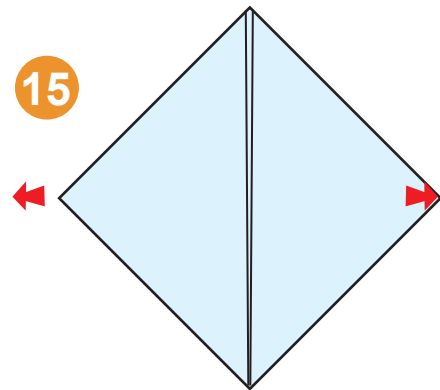
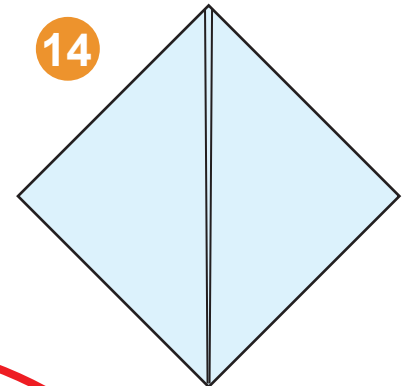
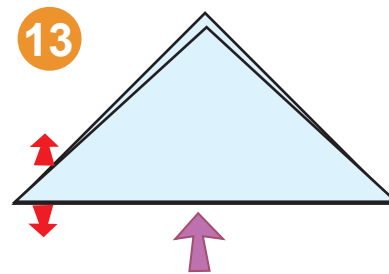
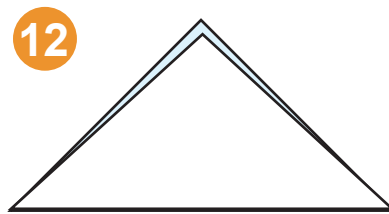
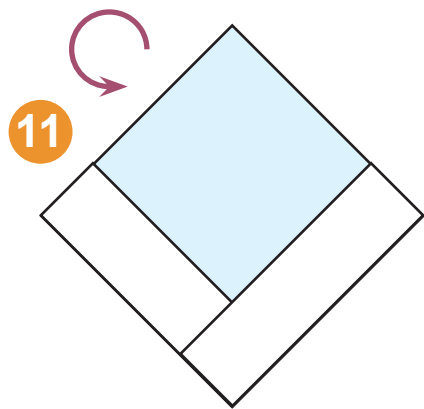
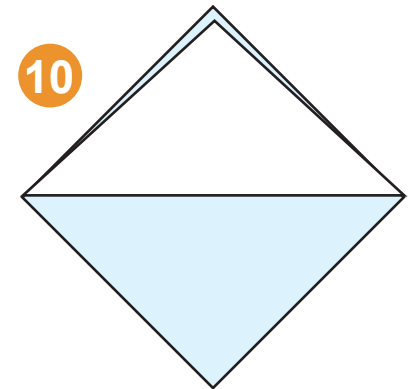
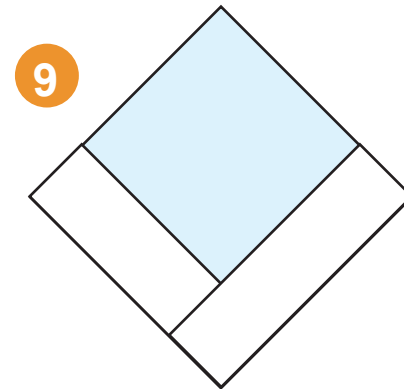
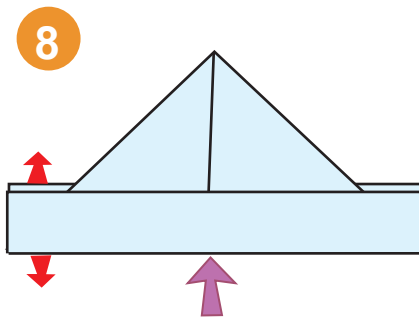
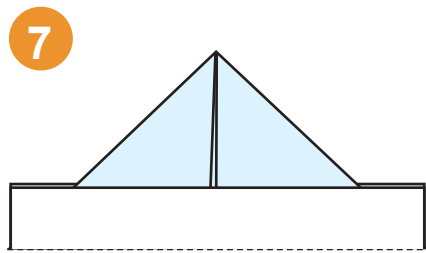
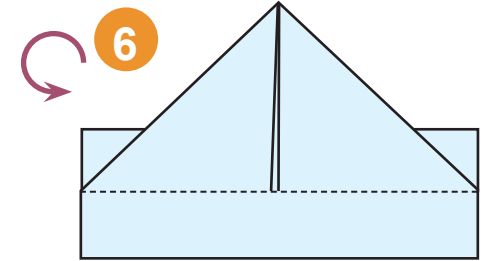
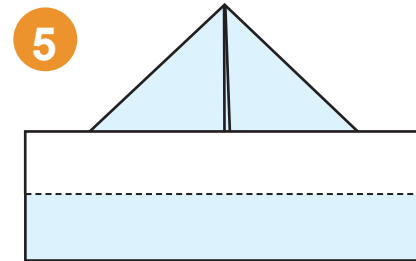
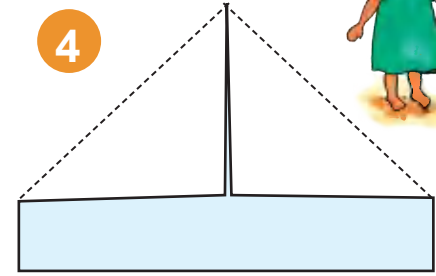
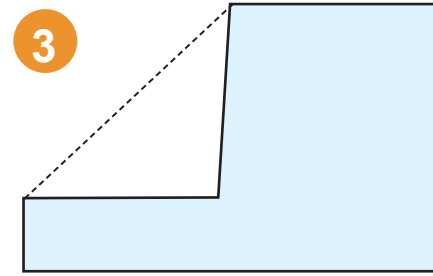
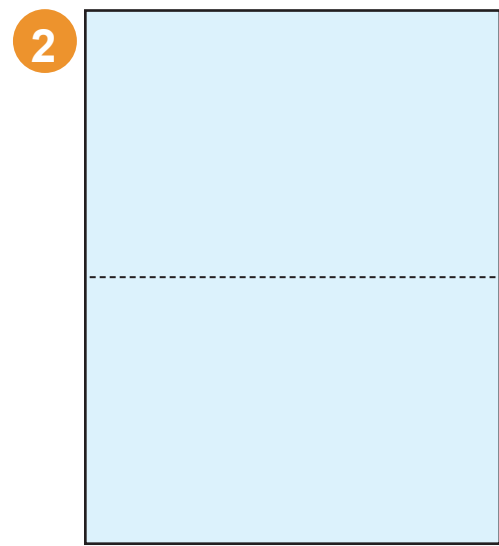
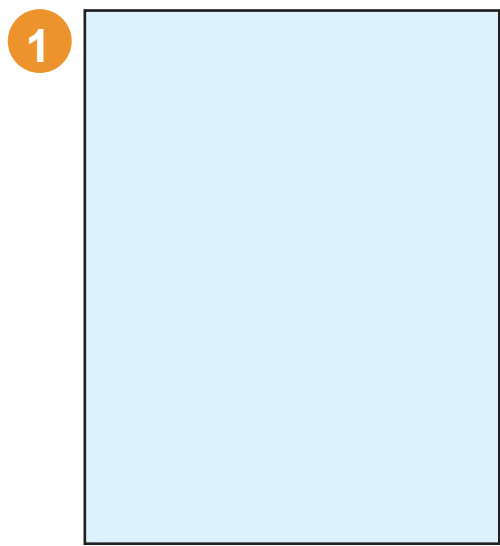

Winia naarka:

Kanu awamu

Tura namak nunia kanu pachisar aujmattsakrin anuikiartin akantratatui papin, kanun najanawarat tusa.

Uchi pujuiniamunmanini papi keaku takusam naka wajasta turam takakmati papinium aarmau ainia nuu mash nakumkata uchijisarat tusam.

Shiram jista uchi ame turame nuna metekash nisha metekash nakuninia tusam, tura nuna umiach matinkia ame yainta.

Nuniak kamu papi niniukam najaname nuu anujkata, tura entsanmasha jukimnialulitane.

Nakumkata kanu tura nunia kanusha tunia ukutayi nuu.

Kanu warukuki nuu pachisam aujmattsata tura unuikiartintrum kanun najanatas kirakan ninia nuu jiisam kirak niniuram amesha kanu najanata.



Winia naarka:

Junis ati tamau

Jintinkratatin ame takasmaurumnia paan iniakmasta ame wakerukmaurum,
nuniasha itiur ii pujutri kajinmattsuk unuimiartinki tamau unimiartinki tamau
unuimiarmame nuu paan awajsata.

**Ii pujutri kajinmatsuk unuimiartiniuitji tusar aarmaji nuu paan
iniakmasan nakumkam yakarta tura nunia charurta.**





Awantai

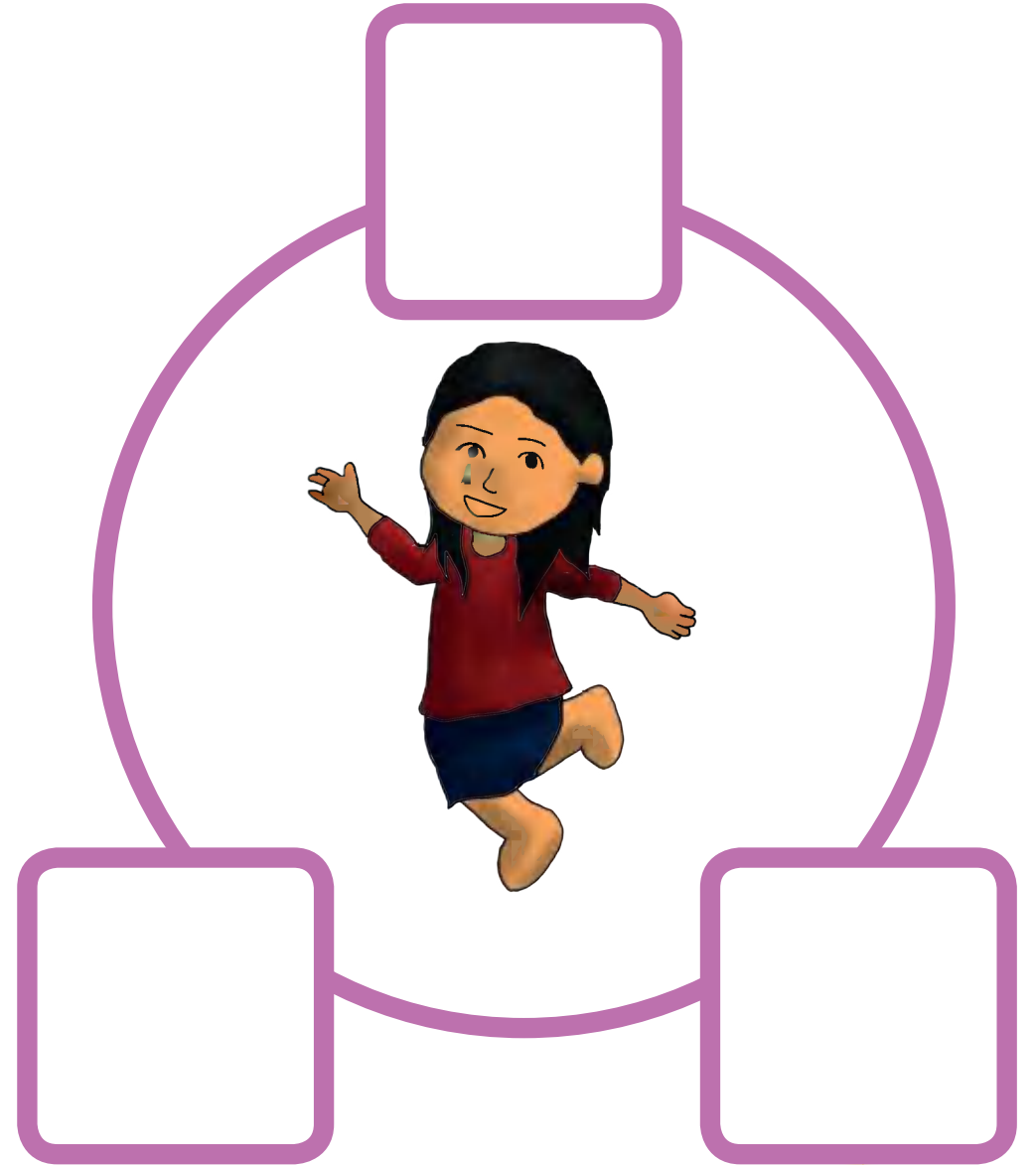
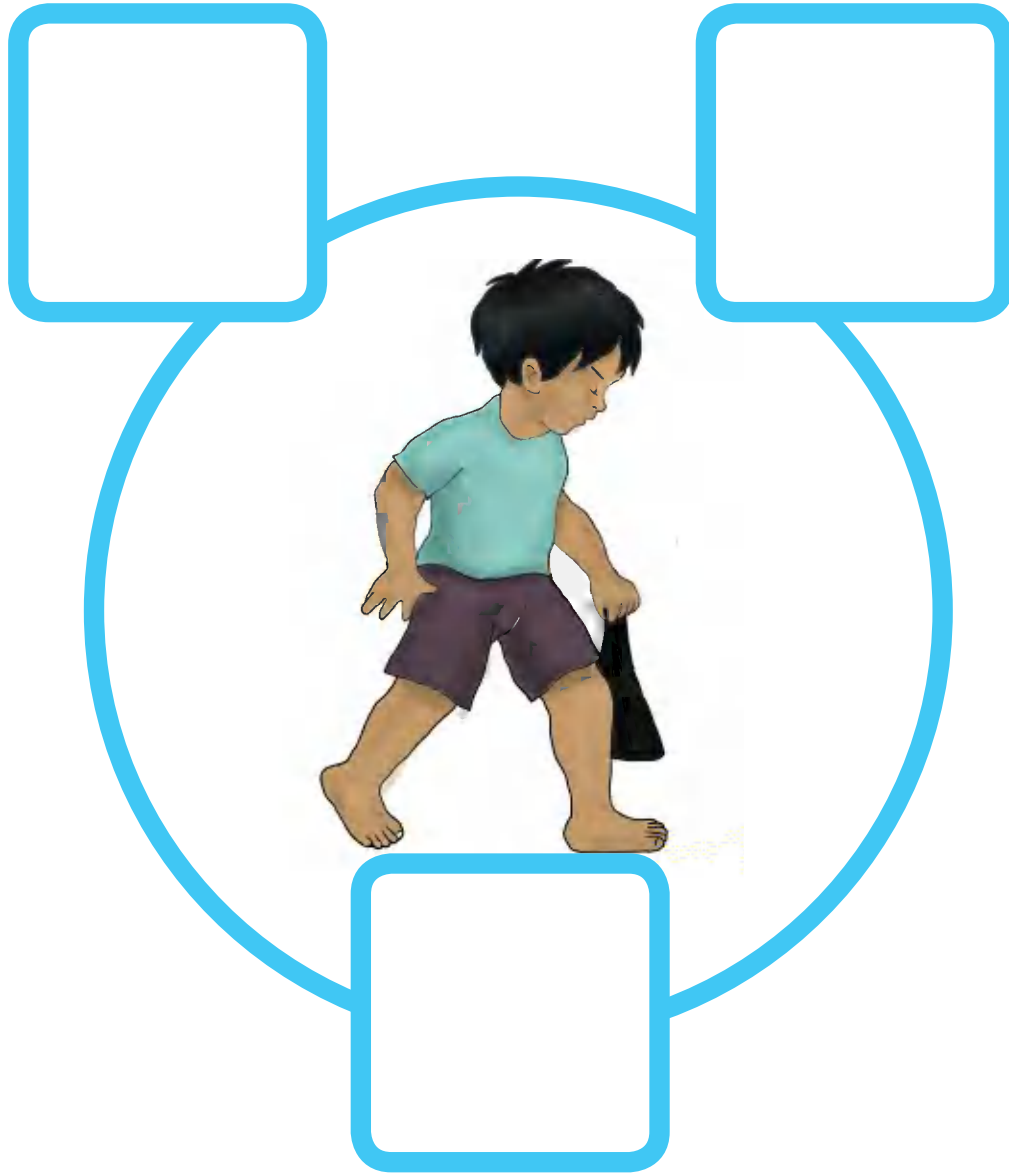
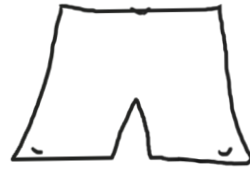

Winia naarka:

Awantai ainu

Unuikiartin unuimiatiniam takawai pachim warinchun awantai irutkamunam ainia nuna:

- ¿Nuwasha wari awantainia awantinia?
- ¿Aishmansha wari awantainia awantinia?
- Uchi ainiau awantmau jisam aujmattsata titia, tura yachik awantinia nuu pachisam tsaniakmaurum ujakarta itiurak awantinia, ¿itiurkami tusaran awantinia?

Uchi inintrusarta yachik awantinia.

Tura nunia juniniawai aishmansha ankan tura nuwasha ankan, tura nunia nekainiawai aishmansha wariniak awantinia, tura nuwasha wariniak awantinia.

Nunianka nii namanchiri warukua ainia nuna pachisar aujmatiniawai.

Aishman nuwaji apatkan jiamsha warukan metekchawi.

Warinma metek ainia.

Takakmati kirak susata.

Pachim awantar najantai chichastaram, nuwash nunia ashmankush wariniak awantash najannia, turam etserkam tukai yapaajnia mura ainia.

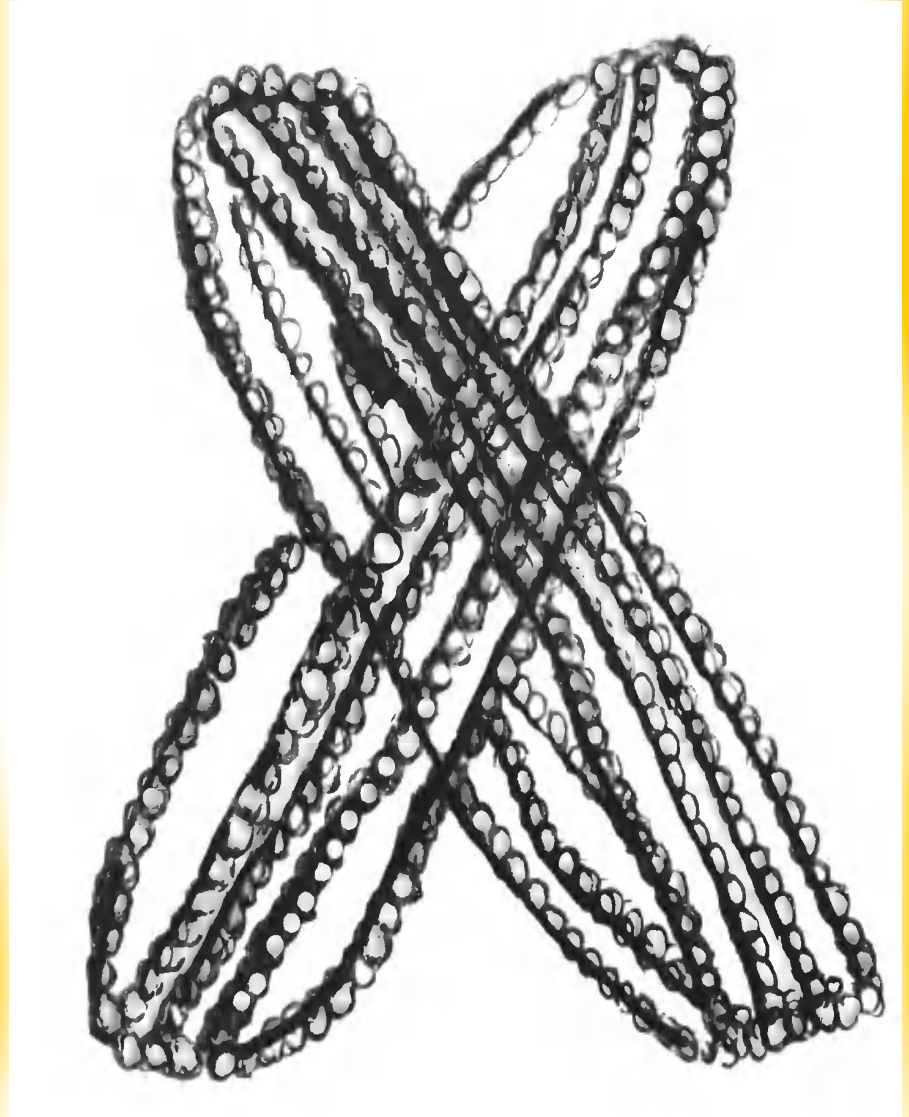
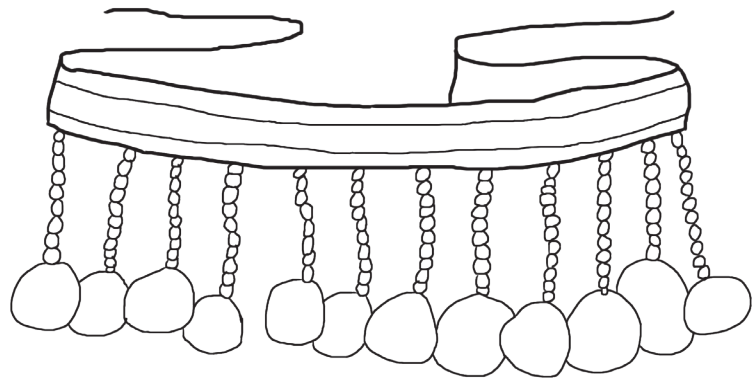
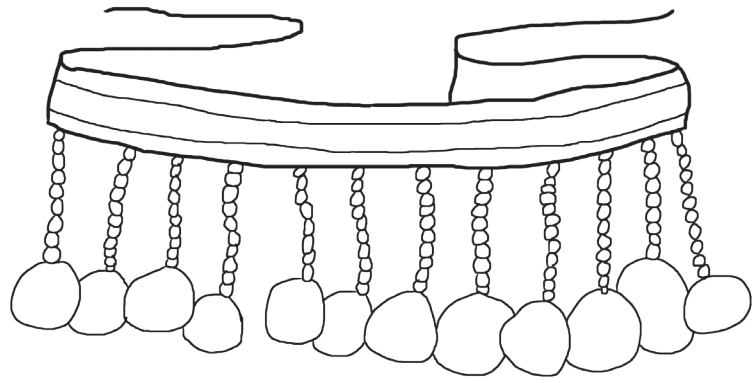

Winia naarka:

li awantairi

Awantai nakumramu ainiau iniak mastatrome turaram naari apujtustaram titia.

Uchi awantar najanamu ainia nuna jisar kichik kichik aujmatiniawai:

- ¿Wari itiurkatniwa ainiawa?
- ¿Yachia awantin arma?
- ¿Warimpia uyumaji awantatasrisha?
- ¿Ami nukurmesha awantan nekewa?
- ¿Awantai ame wakerukmaurum nakumkata?

Takakmati kirak susata awantai ainia nuna nakumrarat tusam.

Aujzata nakumkamu jiasam tura nunia awantamu ainia nuu jiasam nakumkata.



Winia naarka:

Awantamu ainiau jiisam

Penker matsakta.

Unuikiartin mash umisti awantai ainiaun: Yaranken, sentan uruch kutam ramun, numin. Tsentsatin, aakmatin, yakatin nunia chikich ainiaun.

Warinchu sutarach nunia saram ainiau nekaji:

- ¿Tuwa sutarchi?
- ¿Tuwa sarmai?

Tura nunianka yaranjai, aakmatiji, yakatiji nekapminiawai patatin nunia ekemtairijjai tura chikich ainiauncha aintsaran nekapminiawai.

Unuikiartin trus (5) sentan nekapmawai tura nunia matsawai sutarchirin nunia sarmarin juuk.

Takakmati kiraknum takawai troqueljai tura stikerjai.

Senta sutarchinmaya, sarmari juukam matsarta tura nunia uchi susarta nekapmaakam.



Wikia tentewach
shuwinchitjai aishman
wakerutinjai uwejen
jinkiamawar juriniawai
turamti wikia warawarat
weajai. ¡Nusha warinki!

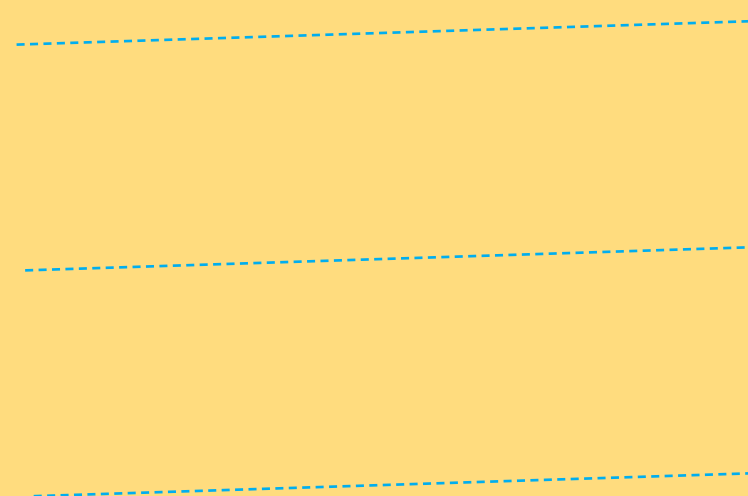

Nupir nunia etse

Uchi ainiau juwiniawai nupiran nunia etseji.

Tuniana juu arma etsencha.

Warukua etsesha ayi.

Uchi ainiau juniniawai etse pachisar aujmattsami tusar.

Wari itiurkatniya penkeraitia etsesha.

Nupir etseji metekkai.

Nupir etseji patkamsha waruka metekchawi.

Takakmati kirak susata etse stikernum nakumkamu pujuinia nuna anujrarat tusam.

Aarmau nakumkamu jiisam aujsata turam inintimrar iniaitiai aikta.

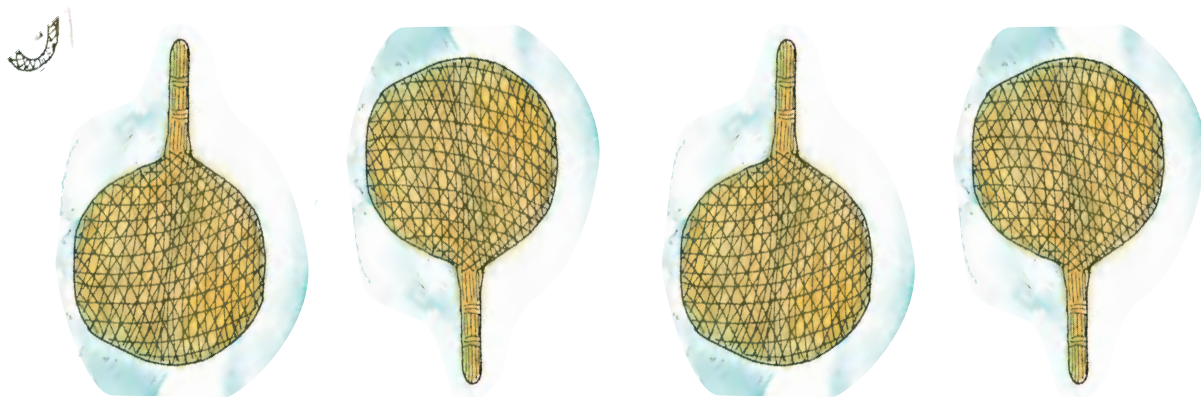

Winia naarka:

Waink

Junikiar nakurusmi chikich uwejen yaki takuiniarti tura chikich uwejen nunka kutsmararti.

Uchi seata wainkun itiarti tusam.

Kichik kichik wain itiamurin aujmatiniawai, tura nunia aujmatiniawai itiur wainkun najanawarmaka nuna.

Nunuanka uchi ainiau nakuriniawai wainkuji waintiumiak wainkun yaki takuiniar, nunkaj kutsmarar, nunia aintsaran majj wajitiuni wajainiawai.

Uchijin matsarta wain.

Aitkasrum takastaram tusa wainkun iniaktawai. Tsentsak mesermaun ureji patak suwawai junaju wain najanataram tusa.

Iniannamunam uchi itiur wain najanamuki nuna aujmatiniawai.

Uchi ainiau aintsarsha wainkuka najanamniawitji tusar tiniawai.

Mash jiiniawai itiur najaniwak jiniawai.

Takakmati kirak susata matsarat tusam, tura nunia stikeram anujrarat tusar.

Wain shiram juukam tsereet matsakta.



Winia naarka:

¿Yachia tawaspancha etsenkrinia?

Unuikiartin tawaspan unuimiatiniam takawai, turamti uchi ainiau tawaspan jiniawai tura nunia tawaspan pachisar aujmatiniawai:

- ¿Yachia tawaspancha etsenkriniawa?
- ¿Yachia tawaspancha najaniniawa?

Tawaspan najanawartascha warinia uyuminiawa.

Wari itiurkatasria tawaspasha etsenkrutayi.

Takakmati kirak susata stikernum nakuminiamu pujuinia nuna anujrarat tusam.

Etserkata yachik tawaspan etsenkrin arma nuu, tura nunia wari kintiatik etsenkrin arma.



Winia naarka:

Titia sentari

Sentan pachimian wankarman, sarman nunia sutarchin juukar matsawai.

Uchi sentaji nii namanken nekapminiawai.

Uchi aujmatiniawai warutan sentanak Titia wejra nuna.

Uchi tsaniakmaurijiai aujmatiniawai warutam sentak muuknumsha tsenkruta nuna:

- ¿Yachia sentancha najaninia?
- ¿Waruka sentancha najaniniawa?

Takakmati kirak susata.

Nekapmarta uwejnum sentaa uwejkamu.

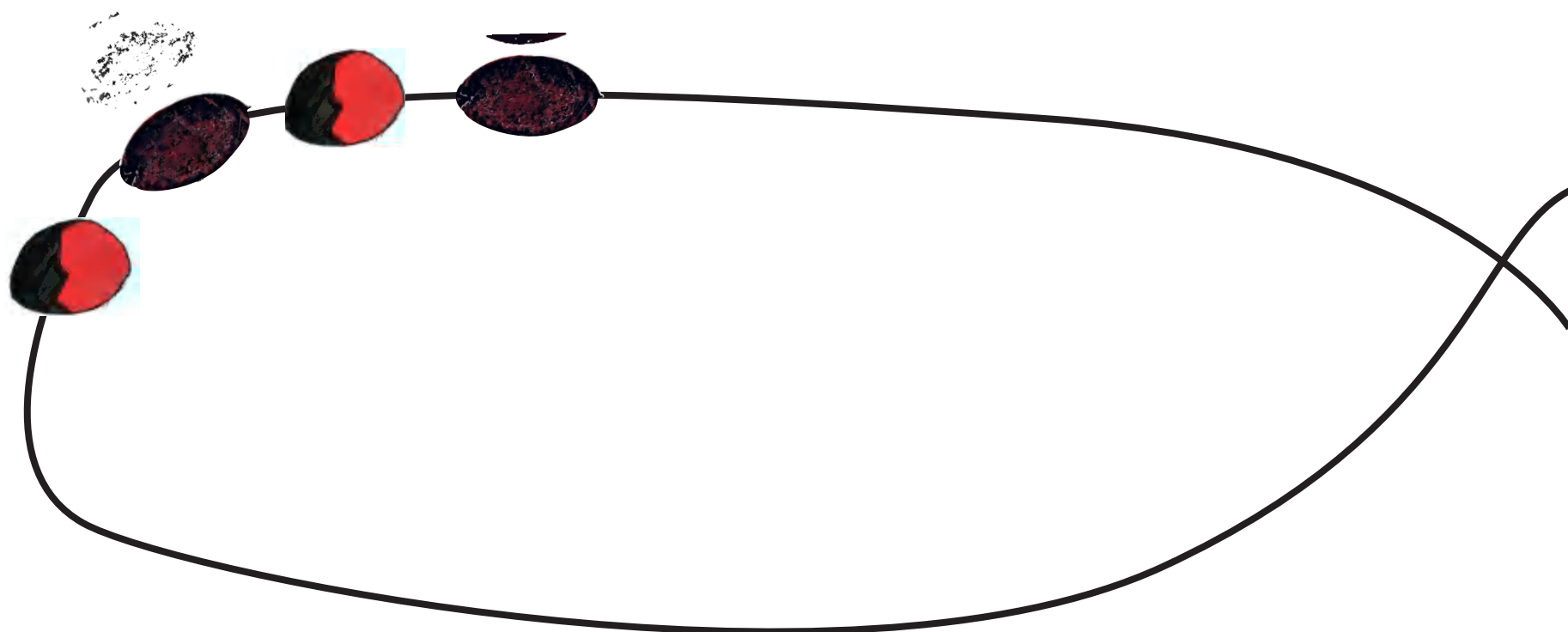

Winia naarka:

Jinkiaij ainiaujai nekami

Unuikiartinka, emak umimias pujawai, nupir nunia etse jinkiajin juuk.

Turachkush, chikich yuranken jinkiajjish takasminiuitiai.

Uchijiai iruntram yuranken jinkiaji pachisam chichasta. ¿Itiur tsakainia? ¿Tuni tsaka?
¿Warukuit? ¿Waruka yumaij?

Yamaikia matsarmi tenap jinkiaij ainiau, unuimiatiniam. Nuikiartin nankamatatui, etsen pujas
nunia nupiran, aintsan, etsen nupiran, etsen nupiran, etsen, nupiran, turuki mash amuktatui.

Nunianka uchi ainiaush nekapruamu nunisaran matsarartatui turachkush ni chikich matsatan
wakeriniaka, turuwarminiuitiai.

Nakumkamu: akankamu.

**Etseriniawai aamaken, kunkurmarin, apuntin, nuniash warukuki nuna, tura metekmar
matsaki amuktatui etsen, nupiran, etsen, nupir, matsaki mash amuktatui.**

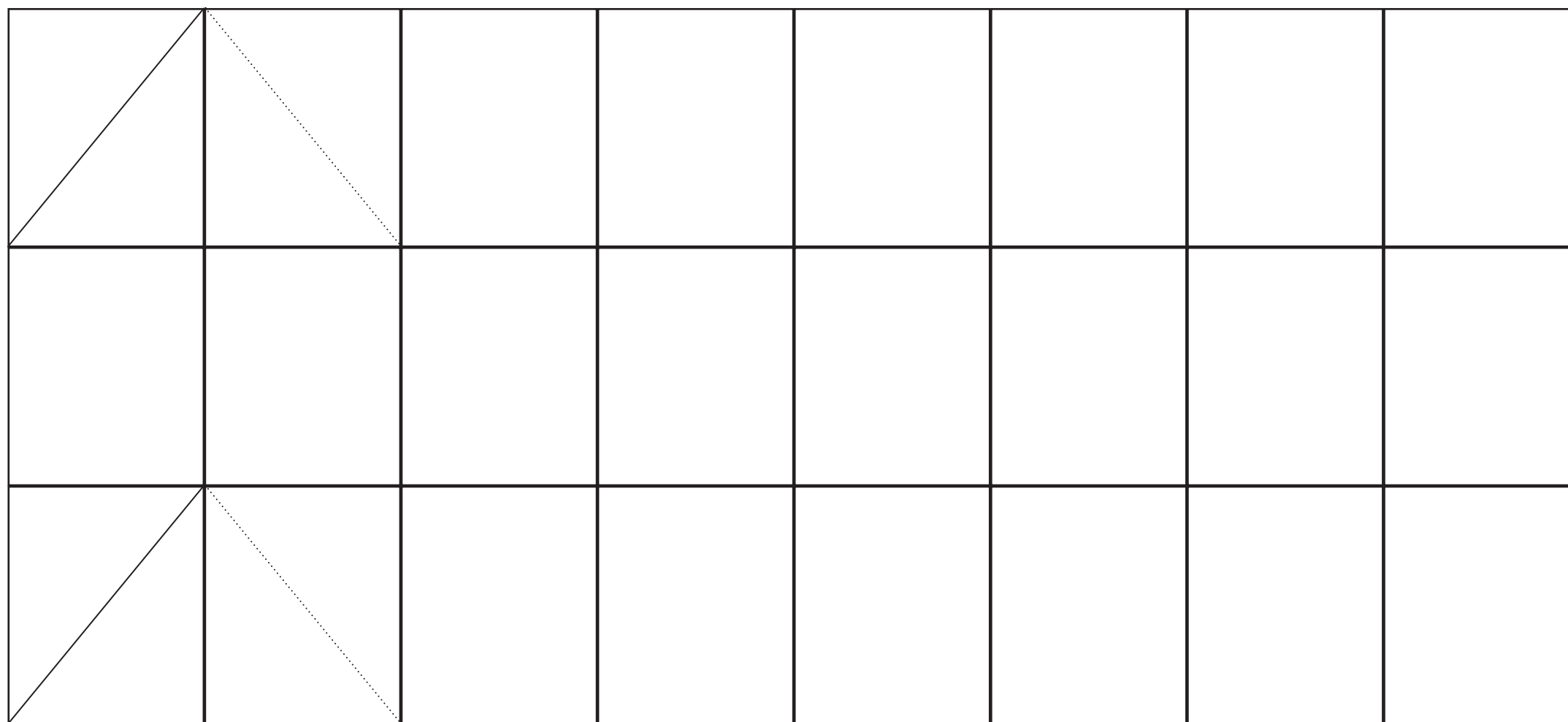

Winia naarka:

Shaak nunia senta

Unuimiatiniam uwejtai nunia jinkiamati takuta uchin nenkamin susami tusan.

Uwejtai iyuntnum chumpiata tura uchi atumek achikrum untsurnumanini patakuimiataram titia.

Aishman ainiau sentanka uwejiniawai, tura nuwa ainiauka shaakun patakuiminiawai.

Uchi sentan jiisar uwejiniawai.

Yainta uchi susarta nawen untsurinini jinkiamawarat tusam.

Tura nunia ujakarta uwejmincha tura nawemnisha untsurumin sentaka patakinkame tusam.

Nakurustaram pirut untsurumjiai nankimkuram.

Takakmastin kirat susata.

Awantai ainiaun pachisar chichainiawai.



Winia naarka:

Atsa apakë uisoki apatikara atsa imainu nonsi ikë

Apach tampu najanin irakmakiakur jisar inintrumi tampusha itiur najantayi tusar.

Uchi unuimiatirin waketkiar aujmatiniawai apach tampu najantan aujmattsama nuna.

Unuikiartin tampu papinium nakumkamun uchi jisarat tusa iniakmawai.

Unuikiartin uchi ainiaun unuiniawai ii juntri takatiri ainia nuna pachis tura asa tampuka penke shirmaitiai tusa uchin jintintiui.

- ¿Tampusha warukua ainiawa?
- ¿Tampuncha yachia najaniniawa?
- ¿Warimpia uyumaji tampu najanatasrisha?
- ¿Tunia wainkamniawitji warincho tampu najantaisha?

Aujmatui awantar najamun, nunia nakapmawai waratam tampuk taama nuna.



Winia naarka:

Junis ati tamau

Jintinkratatin ame takasmaurumnia paan iniakmasta ame wakerukmaurum,
nuniasha itiur ii pujutri kajinmattsuk unuimiartinki tamau unimiartinki tamau
unuimiarmame nuu paan awajsata.

**li pujutri kajinmatsuk unuimiartiniuitji tusar aarmaji nuu paan
iniakmasan nakumkam yakarta tura nunia charurta.**





Mama arakmamu

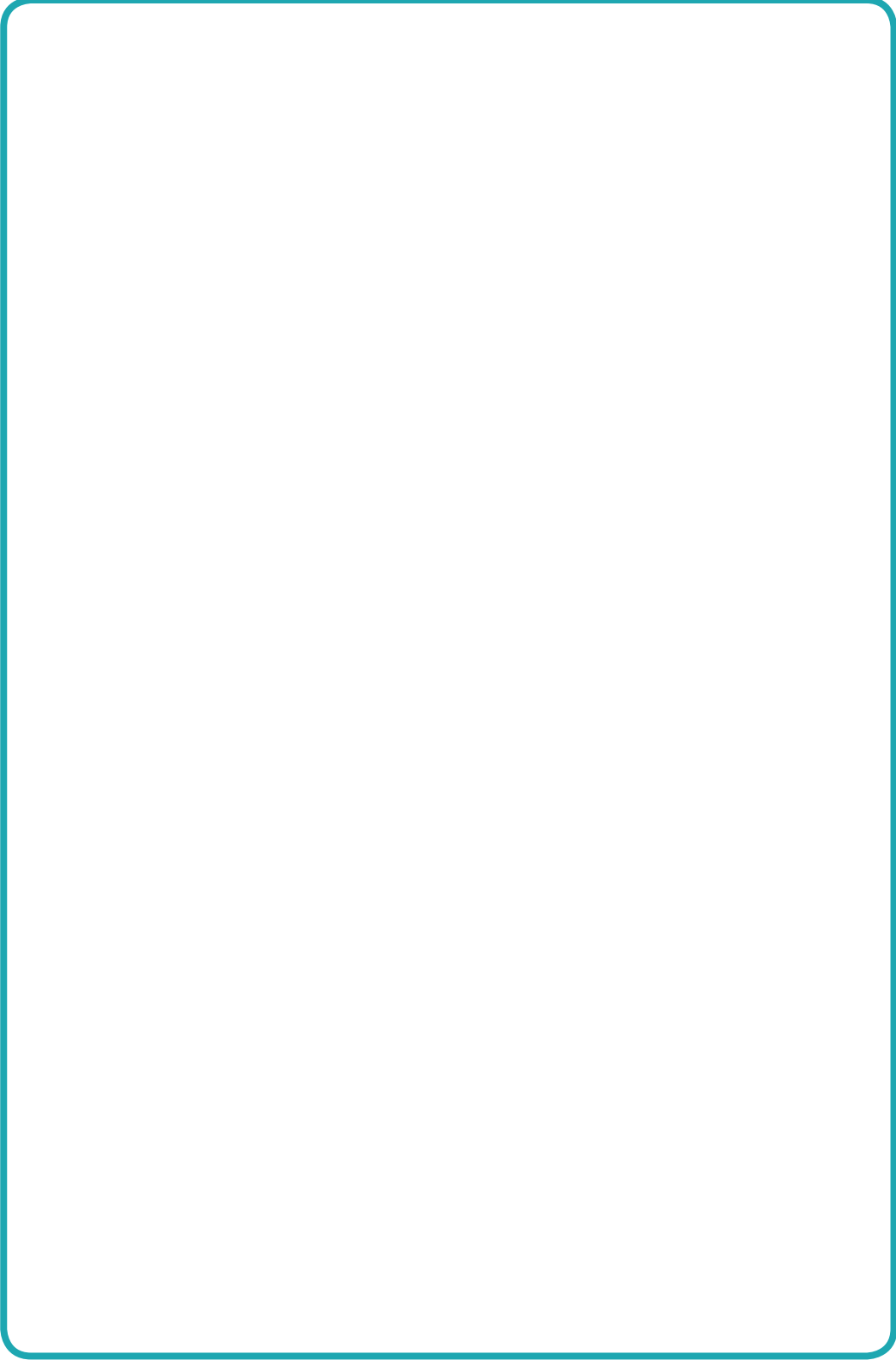

Mama kunchi arakmatasar juamu

Emkaser mama aratar uchiji nukuch iraruweaji initrustasar itiur mamasha aratayi tusar. Ujatmakji mama ajanam aratasikia emkesar tsanin shiram jiisar juukar matsarar nunianka aratayi.

Turam mama shiram mamniayi tusa nukuch ujatmakji.

Nuikiartin nii unuimiatrin waketki uchin ininrawai mama aratasrisha wari itiurtayi timiari nukucha:

- ¿Emkaser mama aratasrisha tsaninkia kunchijisha wari itiurtayi?
- ¿Pachitsuk mama kunchin arata?
- ¿Ami nukurmesha tsaninkia kunchinsha ajanam aratascha tsuwauka?
- ¿Warukaria mama kunchi tsuwartincha shirmaitia?
- ¿Mama kunchi pacjerintiuk aramsha shirnash mama in?

Mama aratasrisha wari enkasrisha itiurtayi nu nakumkaata.

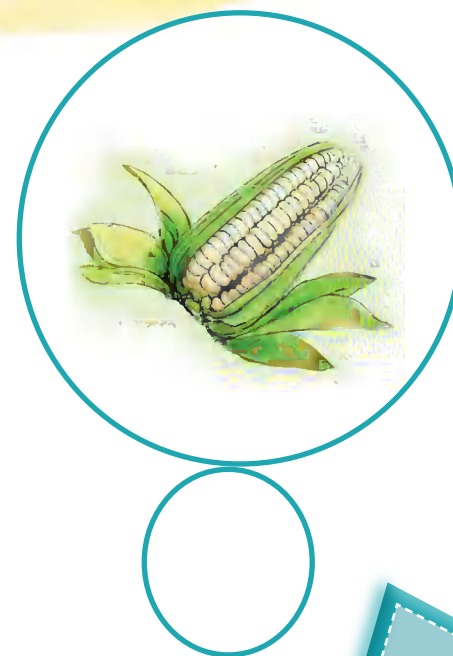
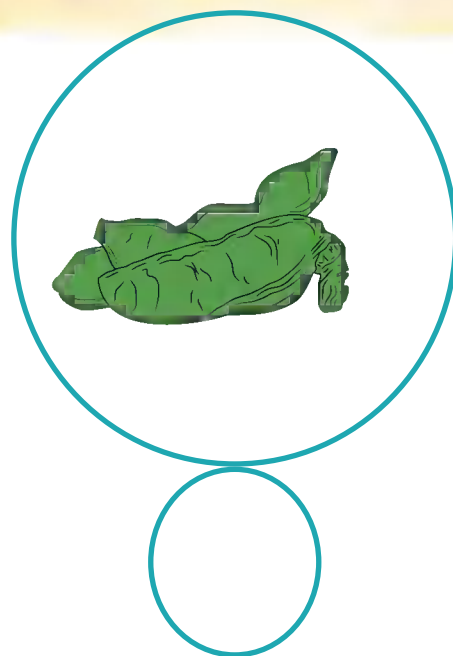
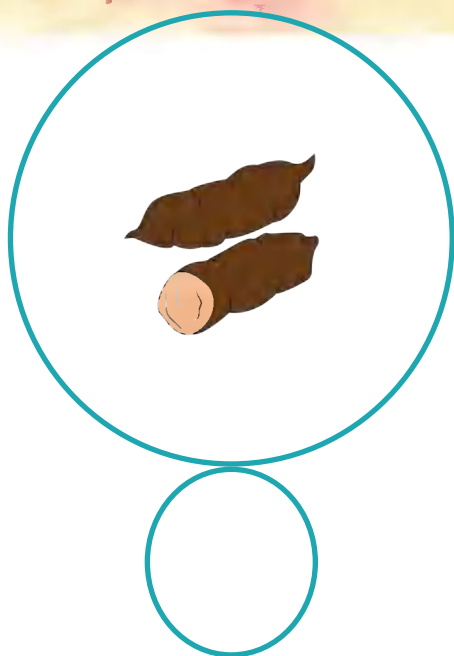
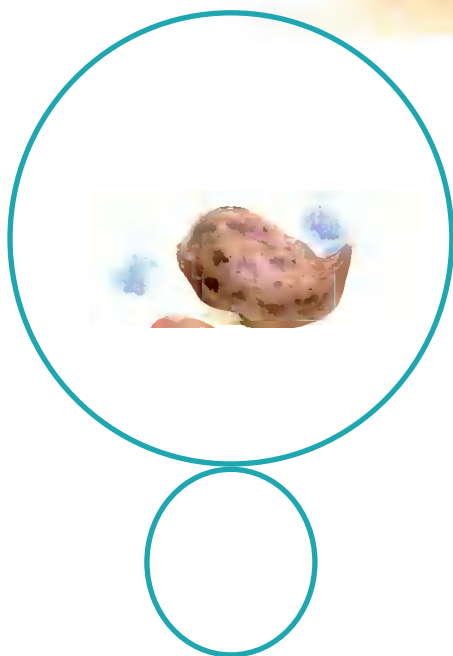

Winia naarka:

Ajanam mama arakmamu

Uchi antukarat tusa enentrawai anent.

Nunkui nuwa asan yurumkan untsuaku winiajai warawarat, winiajai winia nukuchir untsurmati yurumkan sukartustasan.

Uchi inintrusta:

- ¿Wari pachisria anentruaji?
- ¿Itiur mamasha aratayi?
- ¿Warukuna mama kunchincha juu aarma arawartashcha?
- ¿Kichik pukurnumsha warutan mama kunchinia arau arma atumi nukurisha?
- ¿Warutam arakea mamancha pukurin arma?

Nukuch mama arakur anentrutin unuitiamramarme nuu aneakrumek.

Nuniasha mama aramu nakumkamu jisrum aneaku ataram penker.

Mama araji tusam uchiji nakurusta.

Uchi maman arawartas pukuriniawai nii nukuri pukurniana nunisaran.

Ashmankuch pukuriniantai nuwawach arainiawai.

**Nakumkata tsaninkia numiri, tura charuram anujrata juu
ankantach ainia juni.**

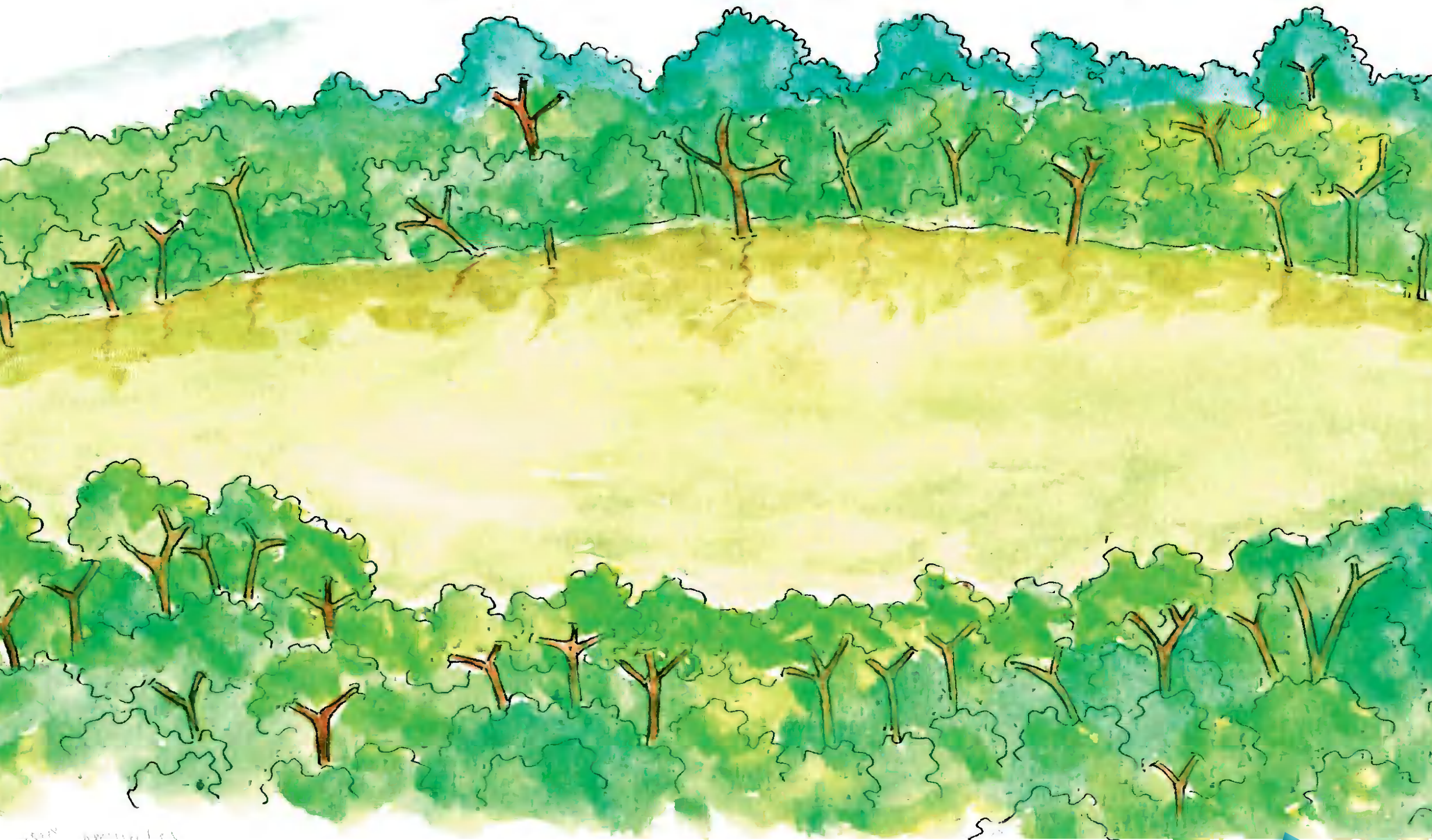

© 2017 WETA-TV

Winia naarka:

Mamasha warijia patkarsha aratayi ajanmasha

Kirika amikë xanu anua unanti bana

Nukuachin ireruwenawai iniasertas mama arakrisha wari yurumkajia patkarsha aratayi tusar.

Nuikiartin nii nuimiattrin weketji uchin iniawai nukuch ujakmaun nunak.

Ami weurmesha maman arakmaksha chikich yurum kanche arauka.

Uchi ainiu nukuachin ipiawari ujatmakat tusar wari yurumka arakmatisha ainia tusar nuna nekawartas.

Tuwa ainiawai juu yurumka penkeri ainiusha tura warukakua shirmaitia mama patkar aramsha.

Iniamu:

- ¿Yachia mamancha arayi ajanmasha?
- ¿Tura yachia ajancha takayi?
- ¿Warukaria mamasha aratayi?
- ¿Atumi nukurisha arakmin armaka?

**Ajanam arakmati ainiana nuu charukam anujkata.
Turam ame tsaniakmauram ujakta warukaria aisha arakmatayi tusam.**

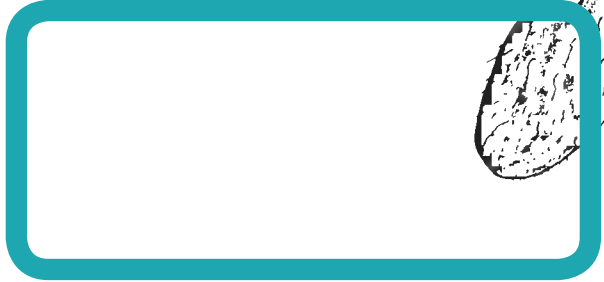
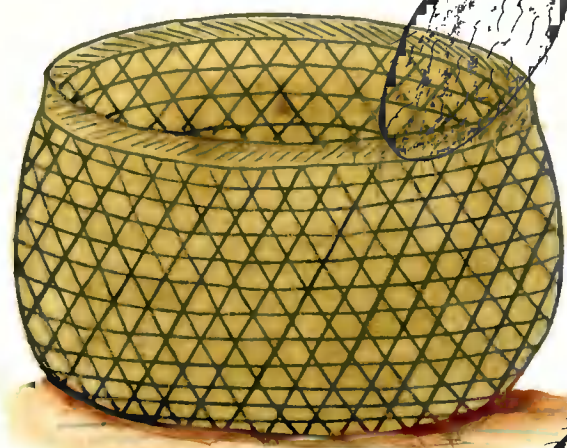
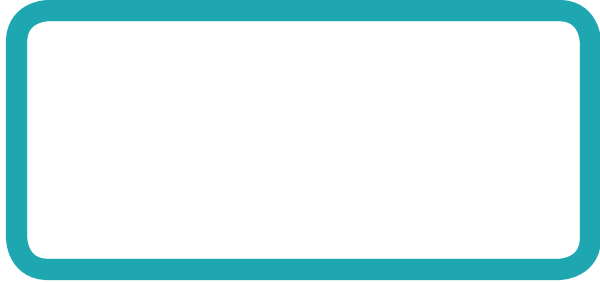
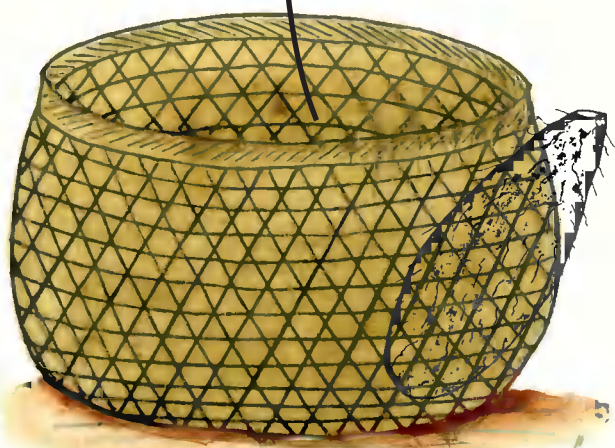

Winia naarka:

Mama ajanmaya uweamu

Nuikiartin uchiji nukuachi jeen irawenawai itior mama uwetayi nuna iniasartas.

Emkachu mama uwetasrisha warin itioritayi nuna nukuchich ujokratui.

Uchiji aujmattsata itior mamancha uweish arma ami irutkamurmincha nuu.

Uchichiji mamam uweajai tusaram nakurustaram tura nunianka pachim arakmati ainia nuu matsarta uchi kichik, kichik maman uweniari metekan, turan nunianka tseret ekemsar nekapminiawai warutam yurumkak uwey tusar.

Numa ujaniniawai uweamusha yupirmash ama tusar.

Nuimiatrim pujusar nakuminiawai papiniam mama uwemaurin.

Takatmati papinian takasta.

Nekata chankinum trus kenke enketu.

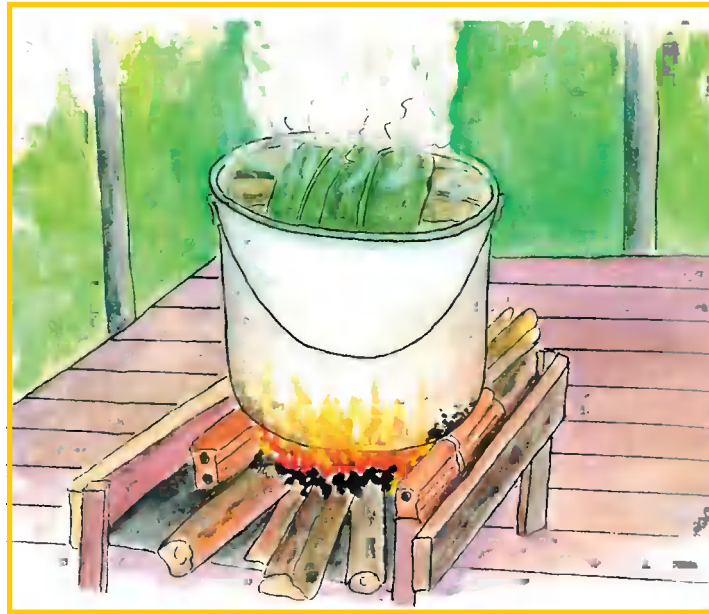
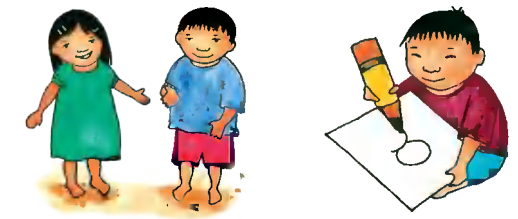

A large rectangular area with a yellow border, containing a red dot in the top left corner and three horizontal dashed lines for writing.

Jamach ijuamu

Uchiji nuikiartin nukuawach jamchin ishuan iraruwenawai inintrusartas, tura nunian jisartas itior maman tsayawak tusar.

Nukuawach ujawai mama ishurtasrikia shiram nijjarar awitiayi tawai.

Nuimiatnum uchi waketkriar aujmatiniawai nukuach ujakmana nunak.

Mama pakamu, tsayamu, tura nunianka nunianka nijjarar awamu, tura narukamtikia narukamtikia inchiji nautayi.

Juniniawai kichik, kichik papinianam nakumkartas tura nunianka kichik, kichik nukuch ujakmaun naarin aatiniawai umisar nii tsaniakmaurin ujainiawai itior mamasha ijiutayi.

Iniamu:

- ¿Mama nawa tasrisha warimpia yumatayi?
- ¿Warinma mamasha aujtayi?
- ¿Yachia jamchinsha nauji?
- ¿Jamanchi ishiurtasrisha wari yumatayi?

Takatmati kirak susata.

Nakumkata nunia Yakarta turam charukam anujkata tanteunum.

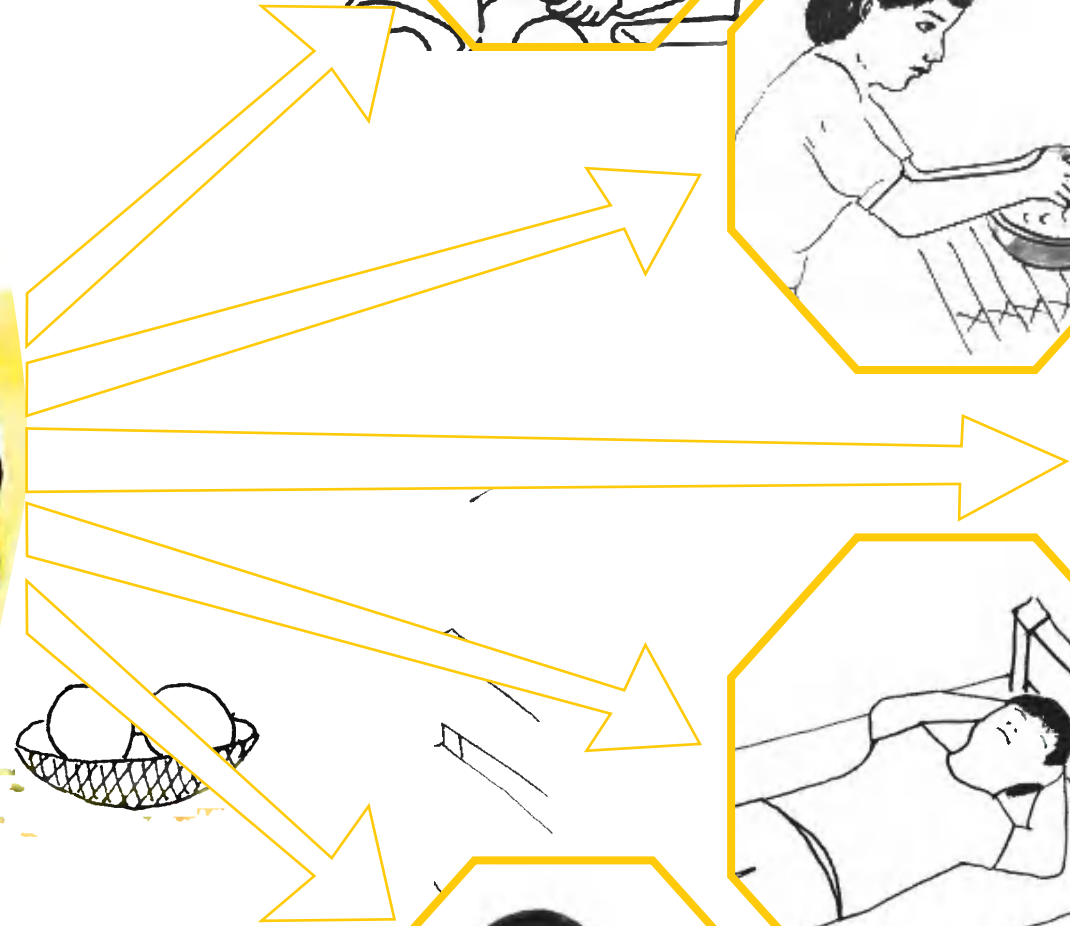

Winia naarka:

Penker najaimiatsuk pujusmi shiram waitmamji

Ipiaji tsuwakratin ii nuimiattrin irartamas ujatmakat warukakun ijjumar penker yuwar pujustincha shirmai nuna – shiram najaimiatsuk pujakrikia penker unuimiartinuitji.

Nuimiattrin waketkiar nii tsaniakmauriji aujmatiniawai tsuwakratin ujakmau.

Inintramu:

- ¿Itiur pujakria shirmasha waitmamkatnuitia?
- ¿Atumsha yuwatasrumsha uwemesha nijiukarum?
- ¿Waruka ijjumatniusha shirmaitia?

Charukan anujkata yurumak nakumkamu.



Munchanchikia ajanan pujawai.
Munchanchikia ajanan pujawai.
Kuwishchiri nawechiri sutarchitiai.
Kuwishchiri nawechiri sutarchitiai.
Inchin yuwatas wakerinchitiai.

Winia naarka:

Anentruami enen

Munchan pachisar.

Anen anentruata uchi antukarat.

Uchi wii tamati atumsha titiaram titia nunia uchiji nampeasta.

Nunia uchi anentramun antukar nii namanchirin umuchkiartatui anen wari tawa nujai metek.

Inintrusta:

- ¿Yachia pachisria anentraji?
- ¿Warinia munchansha yuwatascha wakerini?
- ¿Warukua munchansha ayi?
- ¿Tunia munchansha pujuyi?
- ¿Muchan warukua aanuu pachisam aujmattsata?
- ¿Munchanki usuamurisha warukua ayi?
- ¿Tsawaitish munchansha ajanmasha wekainiuka?
- ¿Warukakun kashitisha wekainia?

Nekata wari kuntin pachisria anentraij tura nunia stikernum nakumkamu pujuinia nuu jukim jisam tunin anujramniawai nuni anujkata.

Wapuka yurumkam

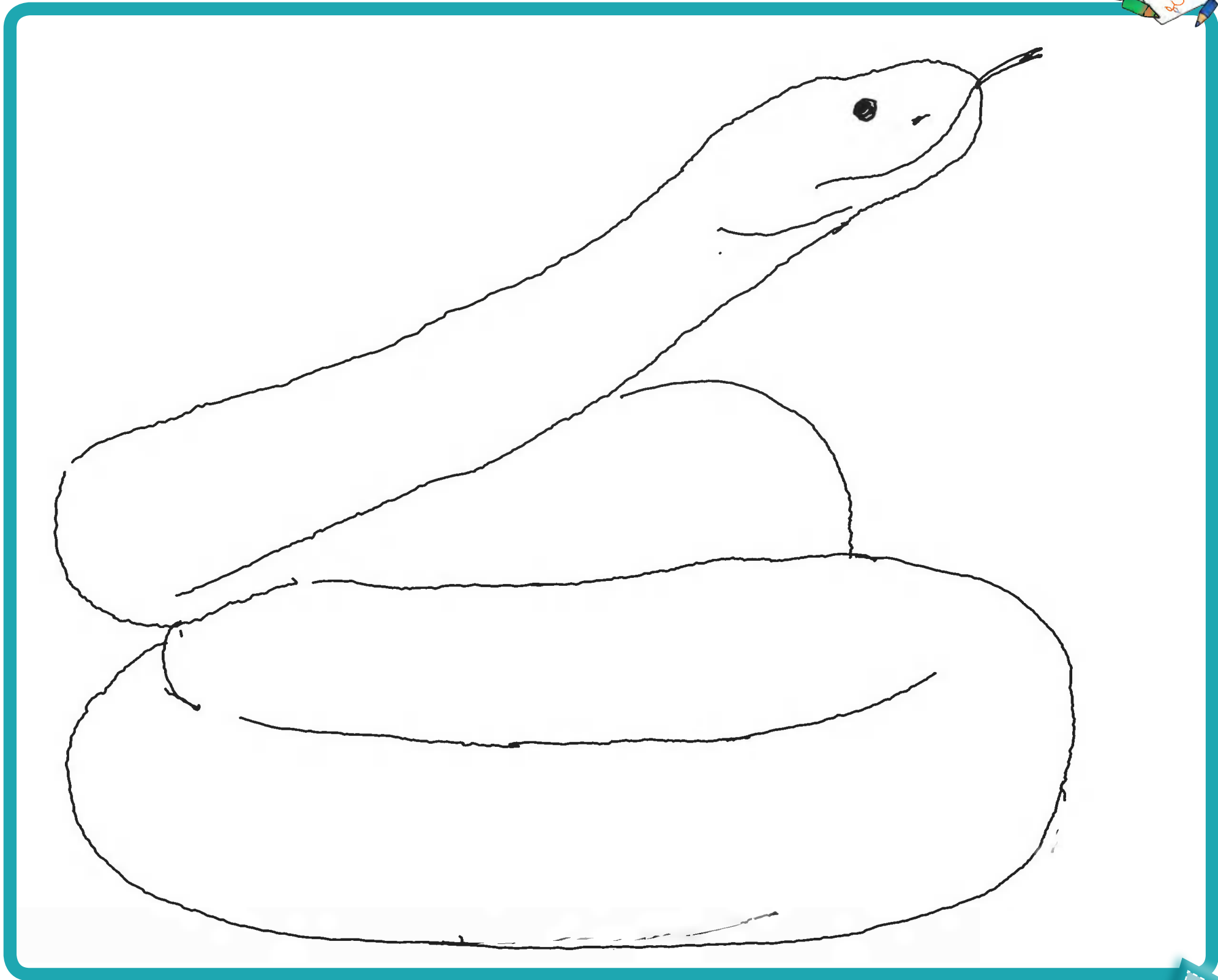

Winia naarka:

Wapuka yurumkam

Sukartinuitia, jun
enentan enentramti
ajanam, pujamtai
wapuka inchi
tukamunam pee
tepeti, inchi nukuri
aa, juun chichainiak
wapuka awatchati
pee yuminkiartin
tiniu aimayi.

1. ¿Wari pachisa aujmata?

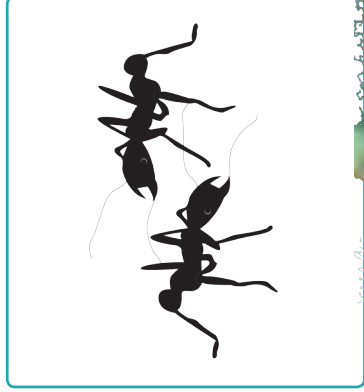
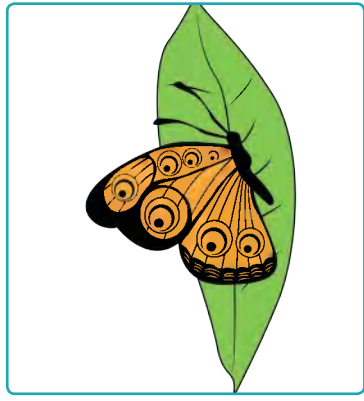

2. ¿Juni pujuyi wapusha?

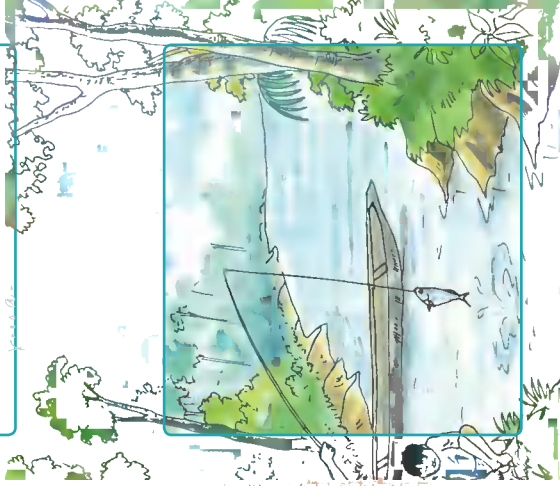

3. ¿Warinma wapusha pujuyi?

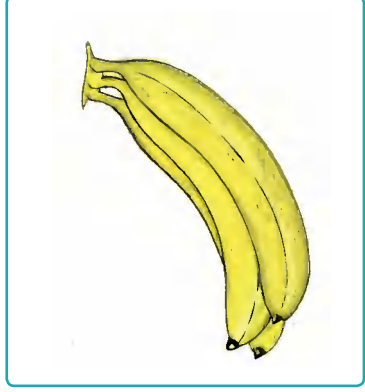

4. ¿Juu aujmatsumusha penkerak antukuram?

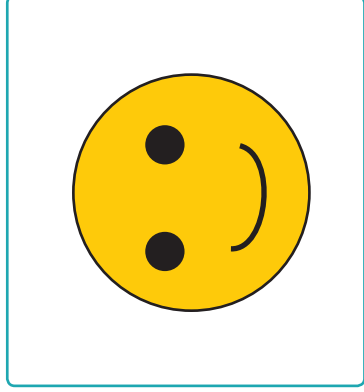
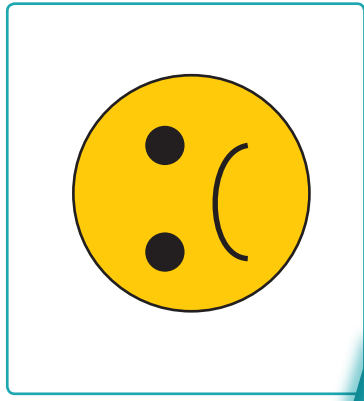

Aja nukurinkia penker wainkatnuitji

Wainkatnuitji.

Nukuach irarsar inintraji mama nukurisha itiur wainkatniuki nuna pachis ujatmaka tusar.

Unuimiatirin waketkiar tante najawar kemsar ujaniniawai antukmaurin.

Unuikiartin uchin iniawai wari pachisria aujmatai tusa.

Unuikiartin uchi etseriniamti aaki weawai:

- ¿Mama nukuri nekarme?
- ¿Warin nankamarain mama nukuari maakrincha?
- ¿Warukan penkerai mama nukuri maakrincha?
- ¿Warukan penkerai mama nukuri penker wainkatniusha?
- ¿Mama nukurisha warinia yush armayi?
- ¿Warukua ainiawa mama nukurisha?
- ¿Warutma ainia etserkata?

**Uchi mama nukuri warukua aa nuetserkata titia turam nunia
tsaniakmaurumjjiai ujaniktaram titia.**

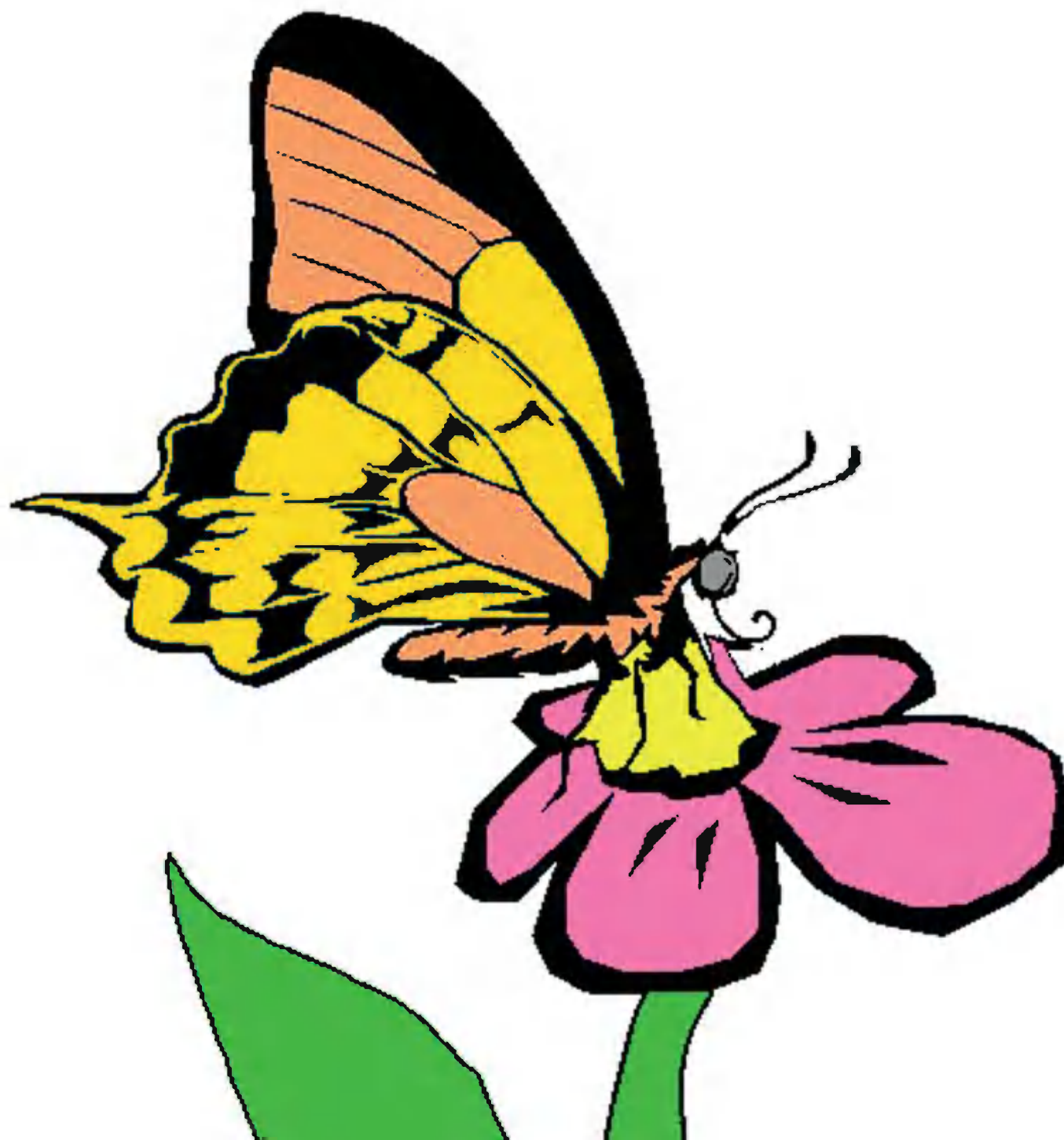

A rectangular box with rounded corners, divided into two sections by a horizontal line. A small red dot is located at the top center of the upper section.

Winia naarka:

Pachim mama nuke

Yuu ainiau.

Nuwa maman aratan nekau iraruweaji warinchi pachim manchi ajanam puju ainiaun pachis aujmatmati antukmi tusar.

Warimpia mama nukencha pajemamtikniayi.

Warimpia maman pasemamtikehau ainia.

Unuimiatirin wakеткиar najaniniawai kiraknum nuwa manchi ainiaun pachis aujmattsamana nuna.

Nakumkar nunianka nii tsaniak maurijiai yapajiwari yaki pee shirman nakumka tusar jiiniawai:

- ¿Warutam manchia ainiausha mama nukencha yuwinia?
- ¿Waruka manchi ainiausha mama nukencha yuwinia?
- ¿Wari manchia mama nuken yuchau ainia?
- ¿Uchisha manchincha takasar minwashi?
- ¿Machcha manchik ainia?

**Yakarta manchi ajanam irunu.
Tsaniakmaurum ujakta warutam pachim manchik ainia nuu.**

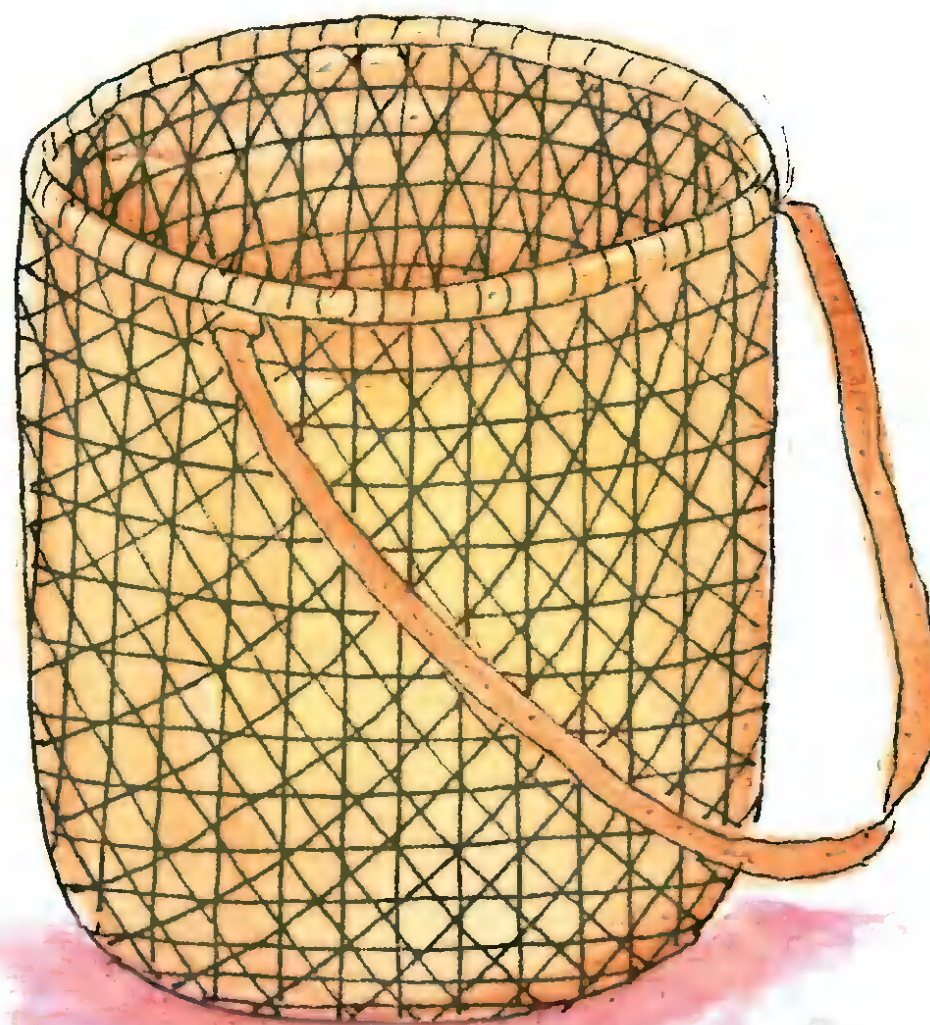
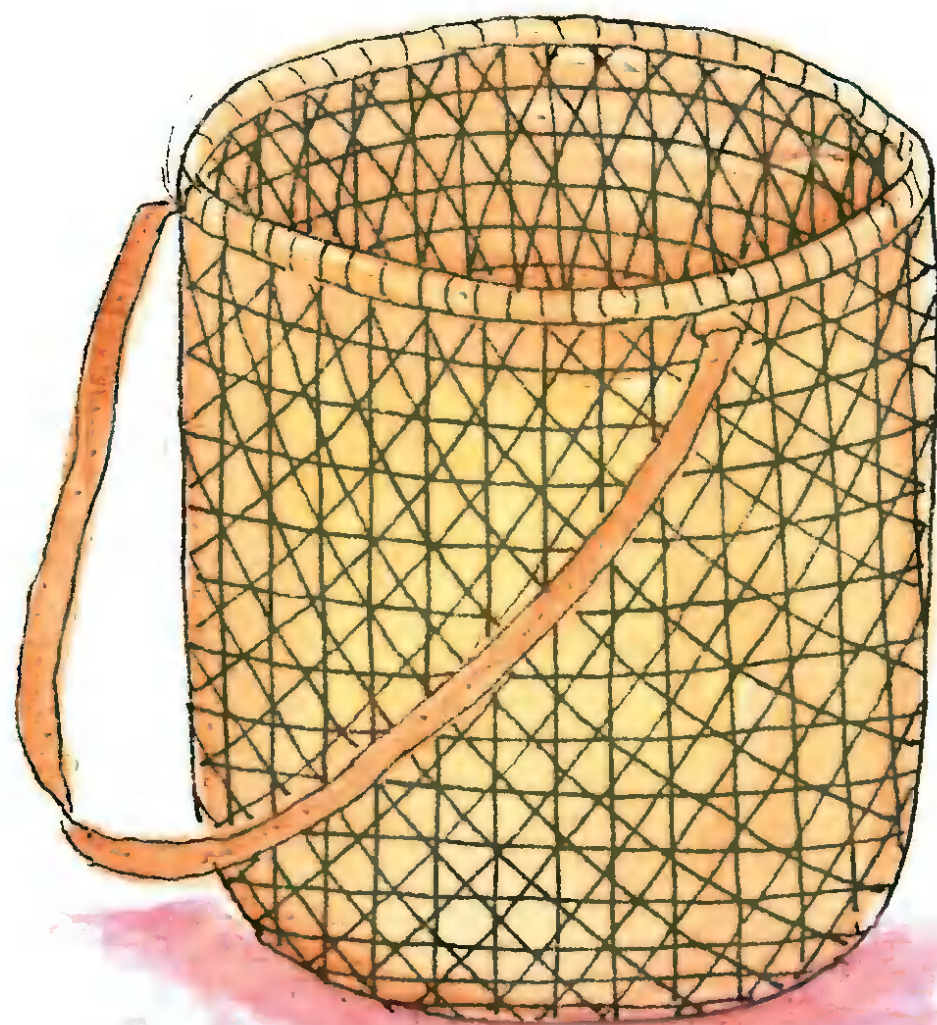

Winia naarka:

Pachim mama

Pachim mama ainiu.

Pachim mama papiniun nakumkamuana nuu iniaktusta jisarat tusam.

Juu ainia pachim mamaka.

Takum mama, puju mama.

Iniamu:

- ¿Mama pachimsha wari tutayi?
- ¿Warukua ayi?
- ¿Mama pachimsha waruka metekchauwitia?

Kompatam juu ainia timi. Takum mama pajumama iniasta.

- ¿Warukua ainia mamasha timi?
- ¿Warukua pachin mama uwetayi?

Turam anturkata nii uchi iniminiana nuu etserkata kichkimsa pachim mama naari warukuitia mamasha tura warukaria uweaji itiuur aujtayi.

**Pachim mama jukam chankinum tuksata tura ame
tsamakmauram meurem ujakta itiuur juutayi tusam.**



1



2



3

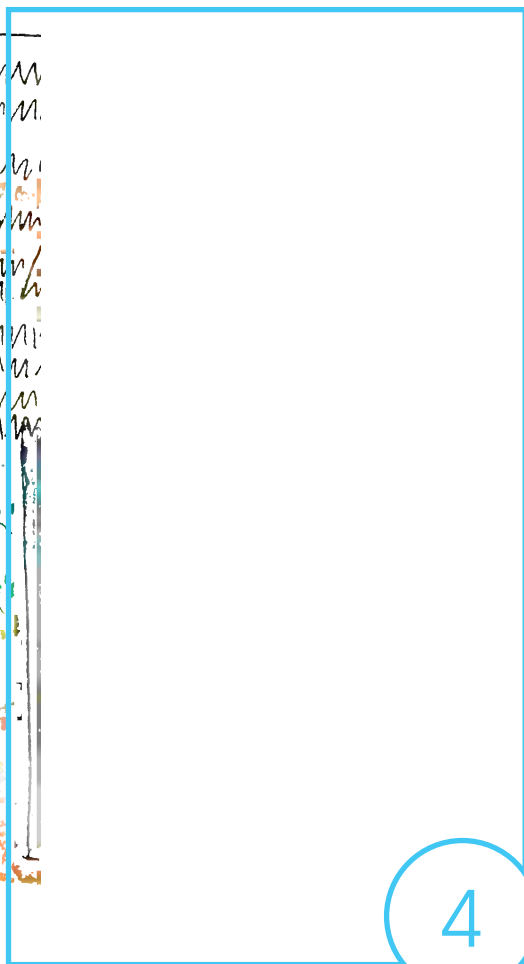

4

Winia naarka:

Nekaji warinian najaniniua

Kirika amikë xanu anua unanti bana

Warin najantan nekau junt iraraweaji, itieur warin najantainki nuna pachis ujamakat tusar.

Nuikiartin chichirin warinian juwawai nii nuimiatrin uchi ainiun ajamsatas. Tura yuwiniak pujuiniamtai ininrawai.

¿Ami wearmesha itieur warinnasha najanniayi?

Turar nunianka nii etsereniawai.

Takakmati papi susata nakumkamuana nuu turar nunian nii nuna pachisar aujmatiniawai

Jintintiata itieur warin najantainki nuna penkeran aujmatsat:

- ¿Emkachusha wari itieurtayi
- ¿Mama nijjarar nunianka kananam chumpiitiayi miniakat tusar?

Takakmati papi susata nakumkat warin najantai.

Nakumkamu charukam anujkata, turam aujmattsata ami wearmesha warinniasha itiura najannia un aujmattsamana nutiksemek titia.



Winia naarka:

Junis ati tamau

Jintinkratatin ame takasmaurumnia paan iniakmasta ame wakerukmaurum,
nuniasha itiur ii pujutri kajinmattsuk unuimiartinki tamau unimiartinki tamau
unuimiarmame nuu paan awajsata.

**li pujutri kajinmatsuk unuimiartiniuitji tusar aarmaji nuu paan
iniakmasan nakumkam yakarta tura nunia charurta.**





Chankin najantai

Winia naarka:

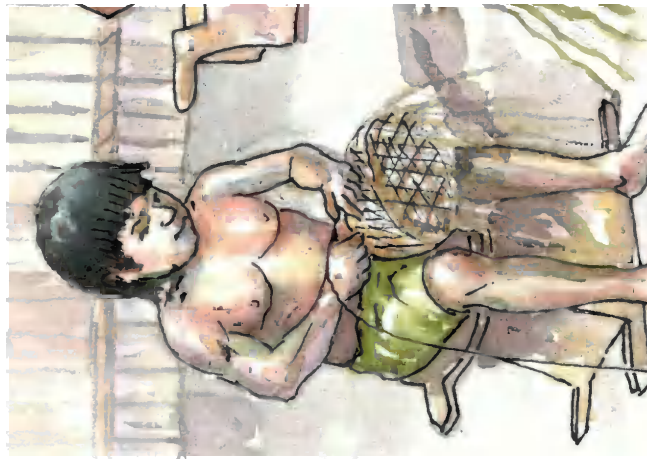

Two horizontal dashed blue lines for handwriting practice.

Two horizontal dashed blue lines for handwriting practice.

Two horizontal dashed blue lines for handwriting practice.

¿Itiur chankincha najantayi?

Ekensataram tanté najanaram. Tura uchi ujakarta warukan yamai aints chankinian najaniniats, chankin najantan kajinmi niakuash najaniniats.

Inintrusta niisha chankin najantanacha nekainiawash.

Uchi chankin itiur najantainki nuu aartaram titia kakimmararain tusam.

Apach chankinian najanu irarutaram.

Jistaram kaap warukujin awanta. Antuktaram apach chankin awantan ujamarme nuu.

Unuimiatirmin waketkiram aujmattsataram apach unuitiamramarme nuu.

Unuikiartin aujui uchi etseriniamti aarmaurin antukarat tusa.

Takakmati kirakan su wawai nunia tishin charurat tusa.



Nintimrar iniait

Wikia untsuriyenjai
numi nantujen
pujuwitjai
antintiniamtikia
yamaik kajewitjai.

¿Nusha warinki?

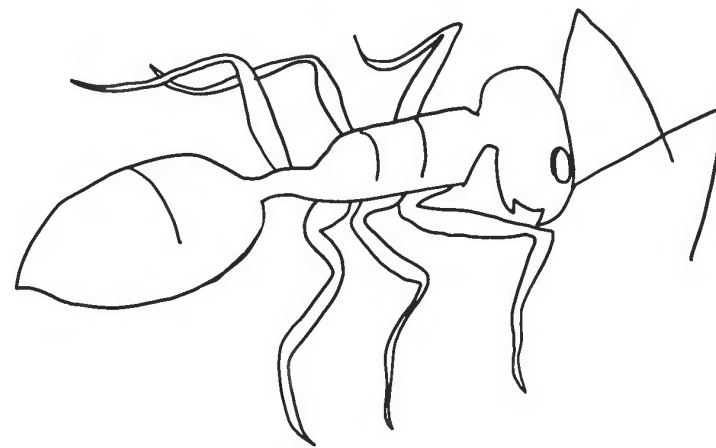
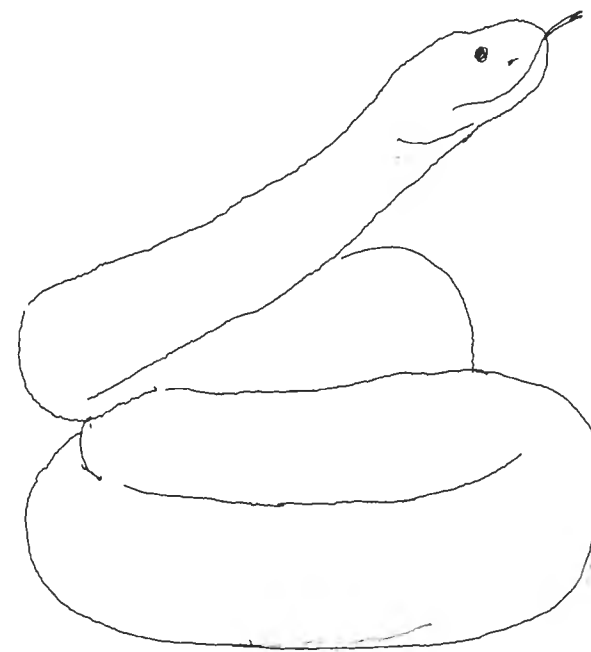

Kaapsha tunin iruna nuna nekainiawai

Juun aujmatiniak kaapkia yutui numi juunnum waka jakamunmaya tsapau tiniu armayi. Tura asamti kaapkia tuke numi juunnum netaru ayi. Kaapin natsuriniakka tsuwi, tsuwi tiniu armayi saram tsurami tusar:

- Uchi apachin irariniawai kaapin pachisar inintrusartas.
- Uchi nii unuimiatirin waketkiar nitiak aujmatiniawai apach aujmattsama nuna.
- Unuikiartin kaap tantekmaun juwawai uchin kaap najantai ainia nuna.

Unuikiartin juunt chankinian najannium ipiayi, tura asa uchi juunt chankinian najanmati jiiniawai unuimiertai tusar.

Takakmati kirak susata chankinian nakumkarat tusam.

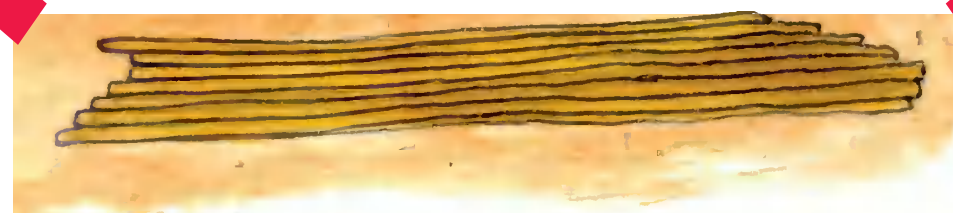
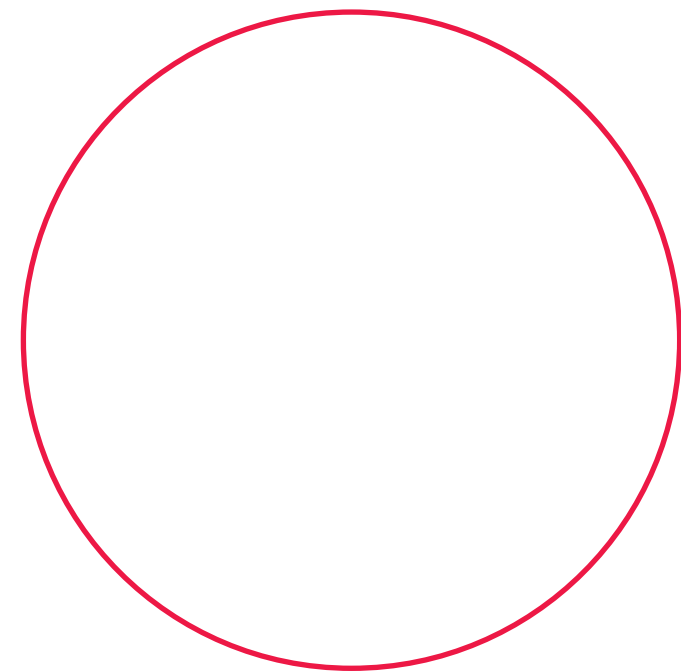
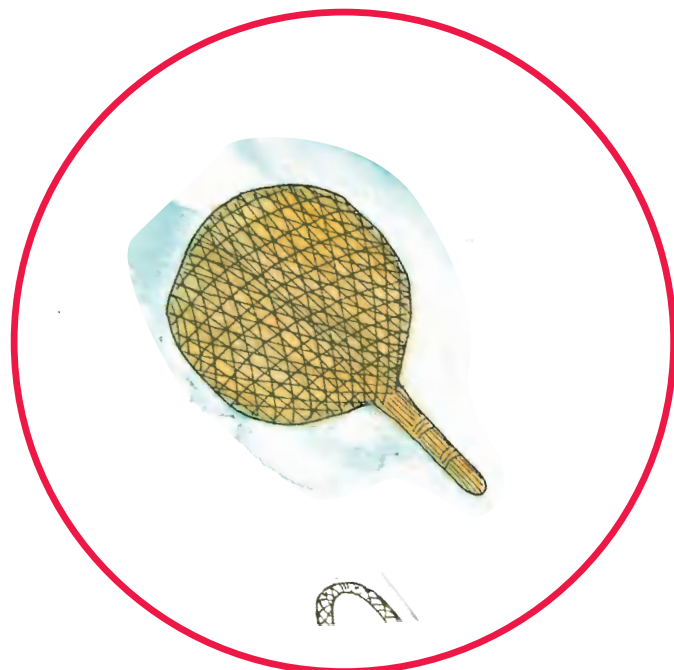
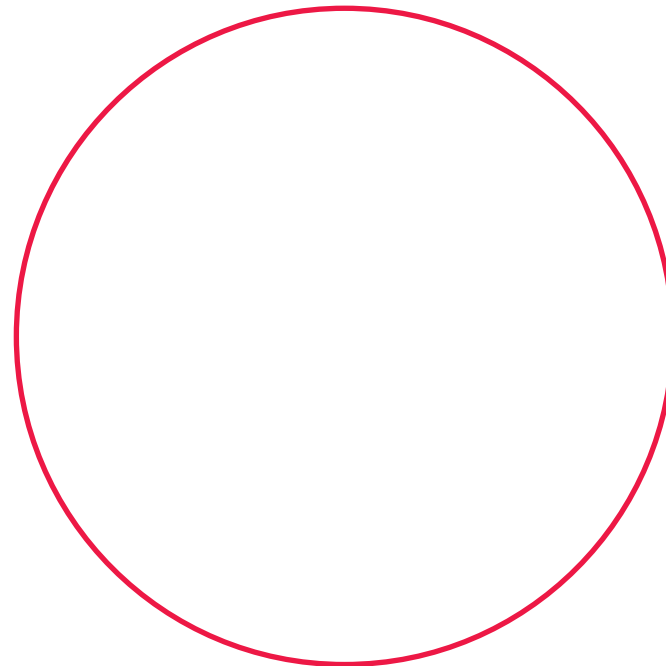

Awantai ainiau

Iniurmi jeen weme jista warinchi kaapjai najanamu pujuinia nuu.

Jeanam wayatin seamtai uchi wajawar warinchi kaapjai najanamu pujuinia nuna achikar takasar jisarat tusam.

Juun etserui warijin juu warinchi najanamu ainia nuna, tura aintsan uchin iniaktawai, kaap, pumpu, kumai, junaji najankamu ainiawai tusa.

Unuimiatiniam waketkar uchin iniaktawai warinchi kaapjai pumpuji, kumaiji najankamu ainiaun: tampun, japimkun, waijkun, nunia tsenkrutin.

Inimmau:

¿Warimpia najantayi juu warinchi ikiam numia jukrisha?

Ujakarta chikich warinchi ainiauka kaapchauji najankamusha ainiawai tusan junaka najaniniawai yaktanam makinjai: kucharan, shirimpin.

Takakmati kirak susata nunia nakumkamu penkerjai.

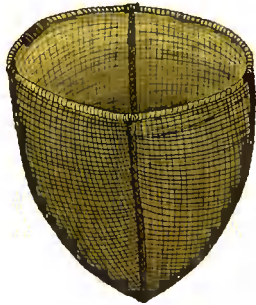
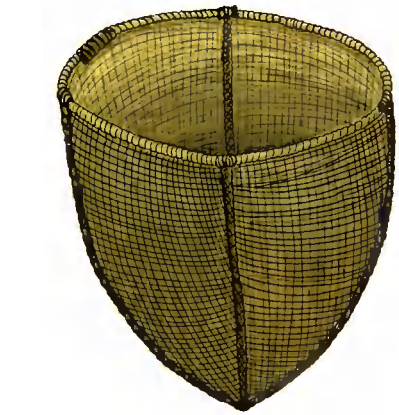

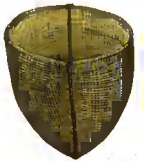
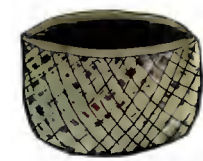

Winia naarka:

Chankin chikich tarimiat aints najanamu

Unuikiartin unuimiatnum juwawai kantuash chankin najanamun.

Unuikiartin uchin ujawai tarimiat aints ainiawuka kichik, kichik chankinnaka najanin ainiawai.

Chankinian patkar jiniawai.

¿Yachia jiamsha metekash ainia?

Chikich tarimiat aints chankin najanamu nakumkata turam yakarta.

Uchi nitiak ujaniniawai chankin najanatniuka shirmaitiai tusar.

Uchi chankinian chichiriniak nankamsar juunnum matsainiawai.

Takakmati kirak susata nunia stiker nakumkamun anujrarat tusam.

Jista nakumkamu. ¿Warukua chankincha ainiawa? ¿Warinma metektaku ainiawa? ¿Warinma metekchausha ainiawa? Chankin nakumkamu yakaram anujkata.

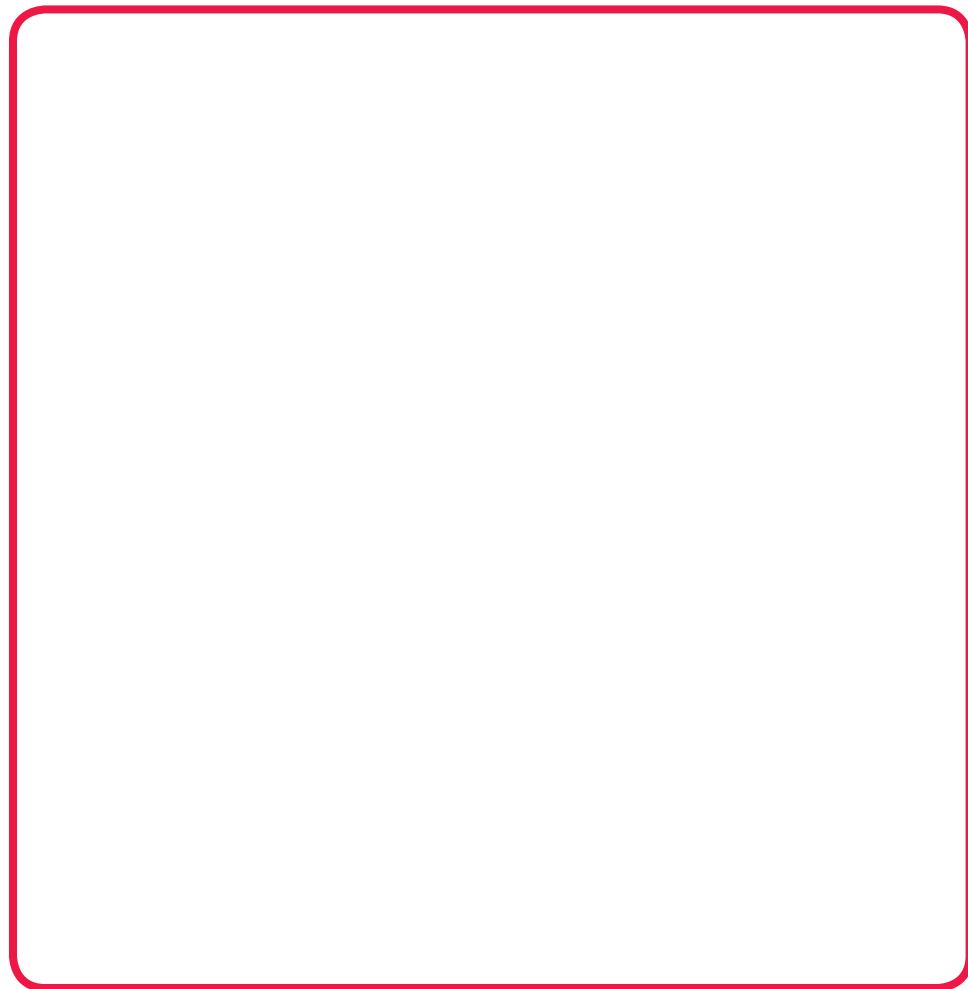

Winia naarka:

Itiur chankin penker wainkatniuki

Chankin pachisam mintramu najanata uchi inintimrar nekawarat tusam.

Uchi inintramun nekawarat tusam najanata kichik inintramu.

Uchi iniasarta:

- ¿Tunia nakurmesha chankinnasha akukmia?
- ¿Itiura chankin penker wainta tusam nekam?
- ¿Chankinjisha nakurusminkai?
- ¿Waruka?

Uchiji aujmattsataram itiura kantuash ainiausha chankinnasha waininia tusam.

Nujrata uchi chankinian waininiau nakumkamanti kara.



Winia naarka:

Aujmattsamu aaja

Nakumkata nakumkamu takakmati kiraknum pujuinia tumamtin.

Uchi atumsha aujmattsamu najanatatrume titia aujmattsamunam aints pujana nuu iniaktusta tura nunianka naari pusataram titia.

Inintramu:

¿Uchisha warin itiurkartasa wakeriniawa?

Nunianka chikich nakumkamu jisrum chikich aujmatmau najanataram.

Aarta uchi turaminia nu.

Tura umisam wakekim aujsata penkerashi tusam, tura yapajiamin amatinkia yapajiataram.

Takakmati kirak susata nunia wakan nakumramu iniannamunam pujuinia nujai.

Aarta uchi turaminia nuu.

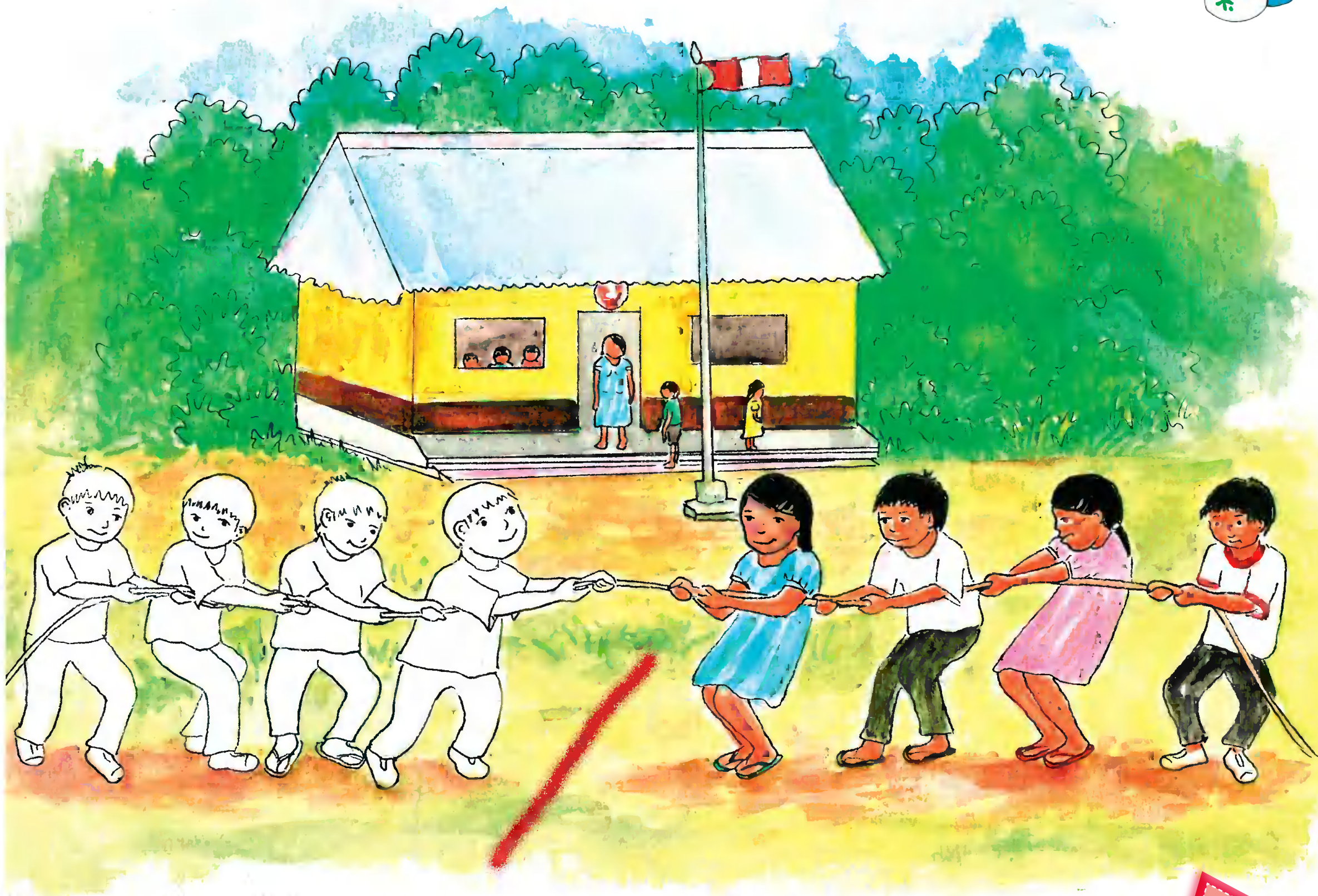

Winia naarka:

Yachia pee mia kakarman japia

Juun uchirtin ainiau seata naek itiataram tusam, uchi nakurumtiksatin.

Uchi juuniktaram titia, turaram tseret junikrum wajastaram titia.

Inintramu:

- ¿Yachia emak wajasta?
- ¿Yachia uku wajastata?

Naek susata. Turam titia ame juni achikta titia, tura ame juu tsakarín achikta titia.

Nunia uchi muukchiri kichik kichik tak antinkam ameka juni wajame titia.

Aitkasam: Juan eemak wajawai, Rojerka Juanku tuntupen wajawai titia, Alanka nuna tuntupen wajawai.

Nunka shait tsentsarta. Yamaikia japiniktiam titia, tura nunianka yachia juu tsentsakmaun nankawa nuu jakertatui titia.

Nuu yachia tsentsarmaun nankawa nuka kakarmachu asa turunatatái titia.

Unuimiatiniam papi akanturta nakurusmaurin nakumkarat tusam.

Kichik kichik nakurusarmana nunisaran nakumkartatui:

- ¿Yachia emkasha wajami?
- ¿Yachia ukunmasha wajami?
- ¿Tuniniya wajamam?

Takakmati kirak susata.

**Yakarta kinkiaji uchi emak wajamana nuna wejmakri tura yakarta samekjai
uchi ukunam wajamana nuna wejmakri.**



1



2



3



4



Winia naarka:

Pachim chankin ainiau

Unuikiartin pachim chankin ainiaun najanamun unuimiatiniam takawai uchi jiisarat tusa.

Uchi chankin ainiaun juukiar matsainiawai tiupchinmaya nankamsar junnum, junnumia nankamsar tiupchiniam.

Iniu pujamunam irawenawai warutam pachim chankinnat takusar pujuinia nuu jiismi tusar.

Unuimiatirin waketkiar ninki aujmatiniawai iniu jeen chankinian wainkarma nuna pachisar.

Unuikiartin apachin unuimiatiniam ipiawai chankinian najanmati uchi jisarat tusa.

Uchi aujmatinniawai pachim chankin wainkamurin.

Nakuminiawai, yakainiawa.

**Pachim chankin wainkamurin etseriniawai, tura nunia
nekapminiawai mena.**

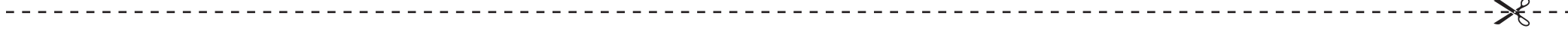
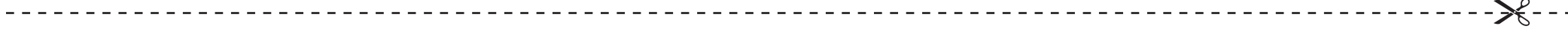
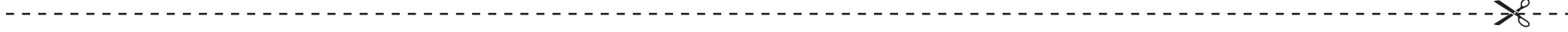
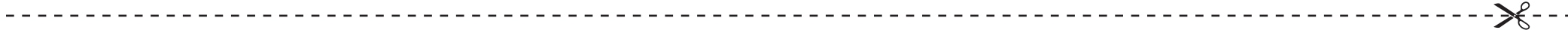
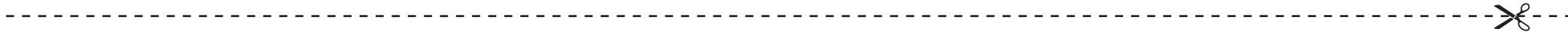
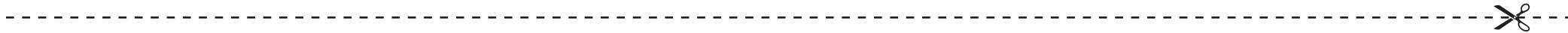



190



Winia naarka:

Junis ati tamau

Jintinkratatin ame takasmaurumnia paan iniakmasta ame wakerukmaurum,
nuniasha itiur ii pujutri kajinmattsuk unuimiartinki tamau unimiartinki tamau
unuimiarmame nuu paan awajsata.

**li pujutri kajinmatsuk unuimiartiniuitji tusar aarmaji nuu paan
iniakmasan nakumkam yakarta tura nunia charurta.**



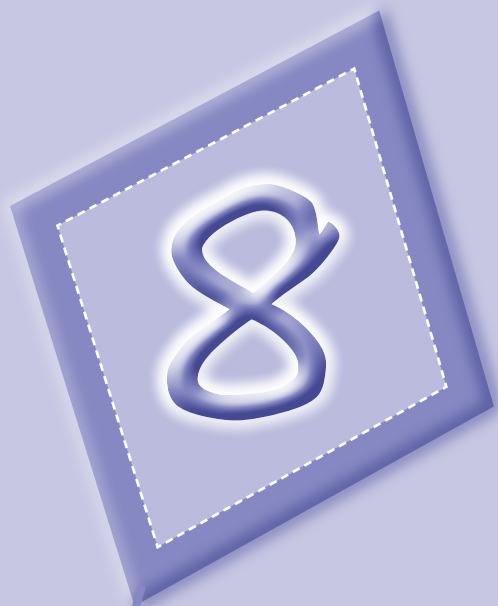

Yuran juukarmi

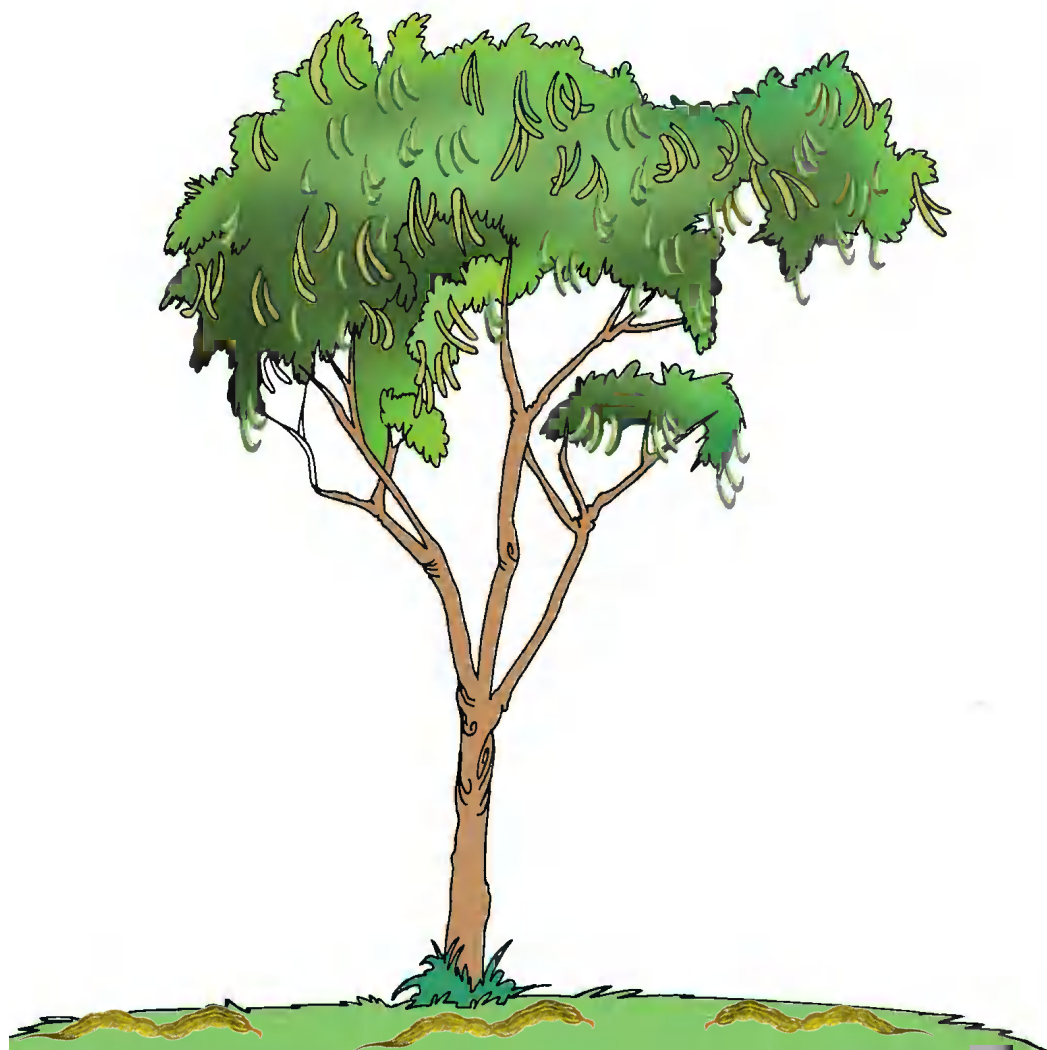



Winia naarka:

Sampi nere juwamu

Apach irarsar inintraji wari nontutia sampisha juuta tusar.

Uchi unuimiatirin waketkiar apach sampin a ujmat samana nuna pachisar aujmatiniawai.

Unuikiartin sampi neren unuimiatiniam takawai uchi jisar nekawarat tusa.

Warukuki nuna.

Tura nuniaka nuikiartin uchin iniawai warukua ayi tusa:

- ¿Sampisha warukua ayi?
- ¿Warita sampisha neeriya?
- ¿Warutia usuamuchirisha warukua ayi?
- ¿Warutam pachimiayi ayi sampisha?
- ¿Tunia sampisha tsapari?
- ¿Sampincha kuntinirantnia ainia nusha yuk arma?
- ¿Wari kuntiniu sampincha yuyi?
- ¿Sampi ajaktincha shirmakai?

Takakmati kirak susata sampi nakumkarat timmi stiker.

**Sampi neere mash nekapmarta turam nunia yakarta akantramunam kichik kichik,
sampi nerejai metek.**

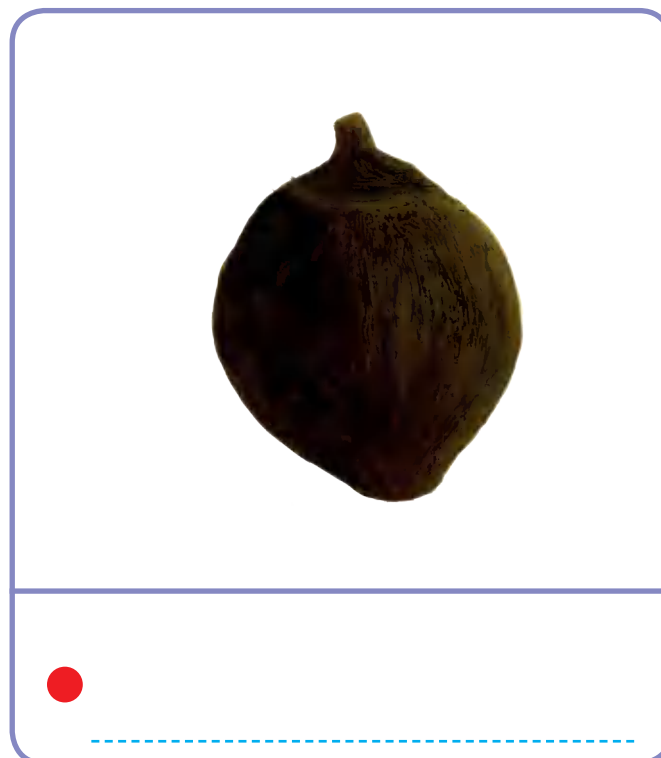
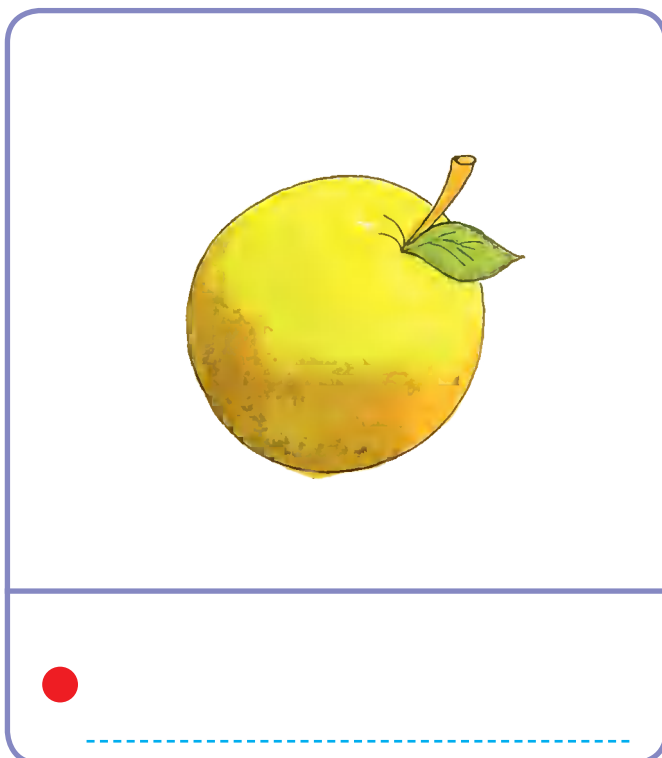
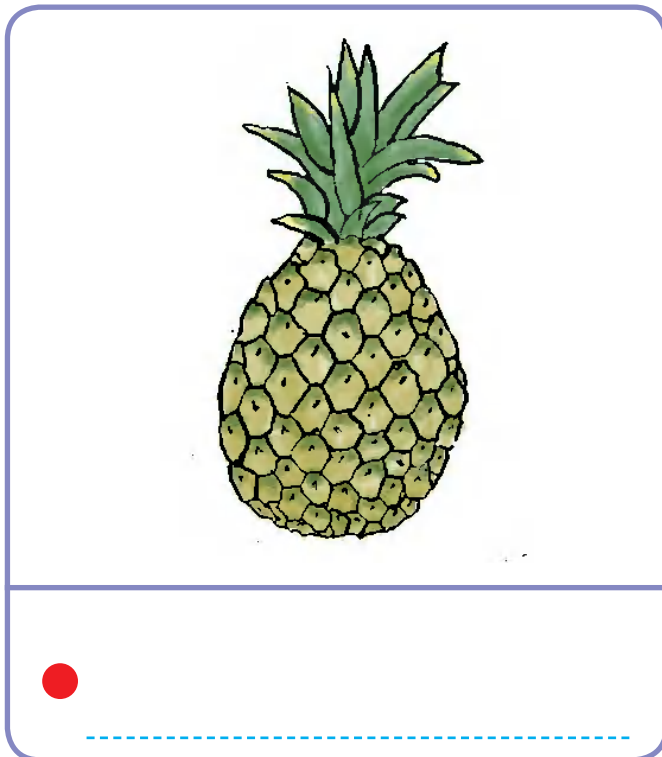

Winia naarka:

Tuniaya shampi ainiausha ajatayi

Nuikiartin uchi ainiauji nukuchin iraruwenawai iniasartas tunin sampi ainiausha pujuinia nuna tura itiur nerasha juutayi nuna.

Nuikiartin uchi ainiaun iniawai.

Yachia sampincha ajayi.

Warimpia uyumatayi sampi juuweakrisha.

¿Uchi ainiausha wenawa sampi juuweamunmasha?

Sampi naari kichik kichik ujakta tsaniakmaurum.

Uchi sampi naarin iniayamti unuikiartin papiriun aawai.

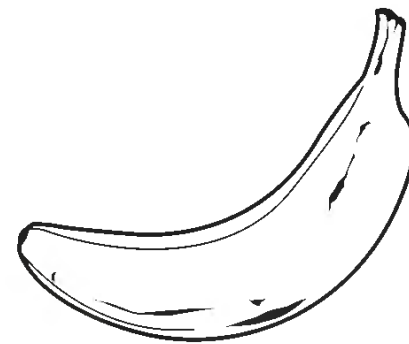
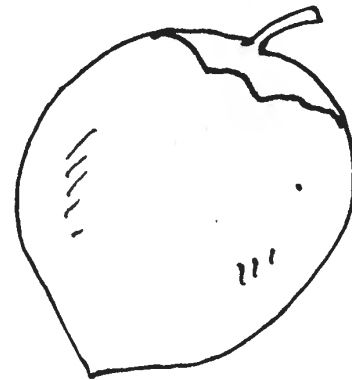
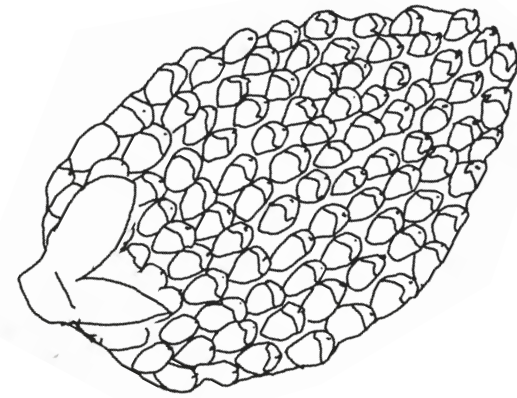

Winia naarka:

Itiur shampish juutayi

Juuntan irariniawai sampi itiur juuktinki nuna inintrusartas.

Itiura sampisha ajakrisha juutayi nuna.

Unuimiatiniam waketkiar aujmatiniawai juunt sampi ajakar juutin etserkamana nuna.

Iniairata itiur sampisha ajakrisha juutayi.

Nakumkata kichik aishman sampin tsenkenjai akau.

Nakumkata sampi chankinum chumpiamu pujau.

Sampincha kuntincha yuuka.

Wari kintiatia sampisha nerena.

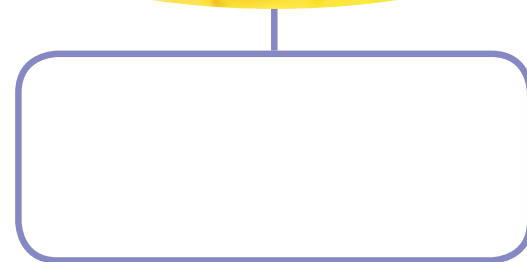
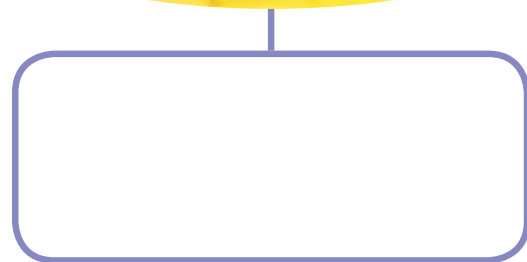

Winia naarka:

Pachim yuran juuti ainia nuu

Juunt irarsam inintrusta warutam pachim yurankea ainiawa timi.

Turam juna iniaikiayi, yaasun, pitiun, papajin.

Nuimiatiniam waketkiaramti nuikiartin uchin iniawai.

- ¿Mash yuram ainiau metekak yumintri ainia?
- ¿Yuram metekak ainia?
- ¿Pau usuamurisha warukuitia?
- ¿Nakar tserempuji patkamsha metekkai?

Uchi yuranken junkar apurinia nankamsar uchichirin matsainiawai.

Nuikiartin takakmati kiraka susam uchi sampin nakuminiawai.

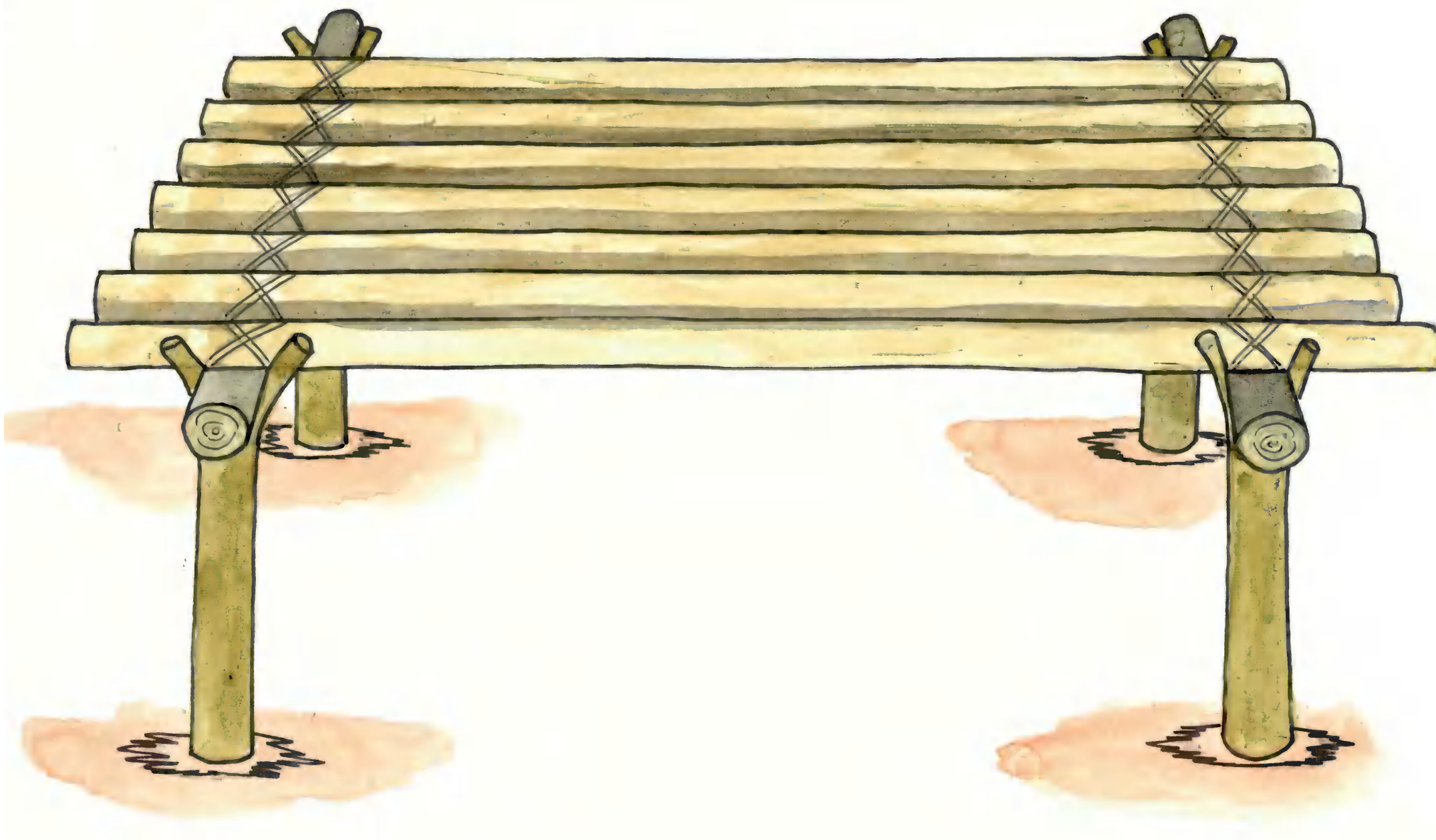

Winia naarka:

Shiram yuran juukar matsartin

Nuikiartin unuimiatiniam itiayi pachim yuranken uchin iniaktustas achun, papajin, narajan tura shirmachin ukusi uchi yuran tsamaun wainkarat tusa.

Uchi warutam kintiajin achu tsama nuna nekainiawai, tura aintsaran papajsha, narajcha wanutan kintia arusan tsama nuna nekainiawai.

Nuikiartintrijiai matsamsar uchi achun painkar yuwiniawai.

Iruntsar aujmatiniawai achu, papai, naraj warutan kintia arusaram tsamararma nuna chichainiawai.

Nakumkam nunia Yakarta achu.

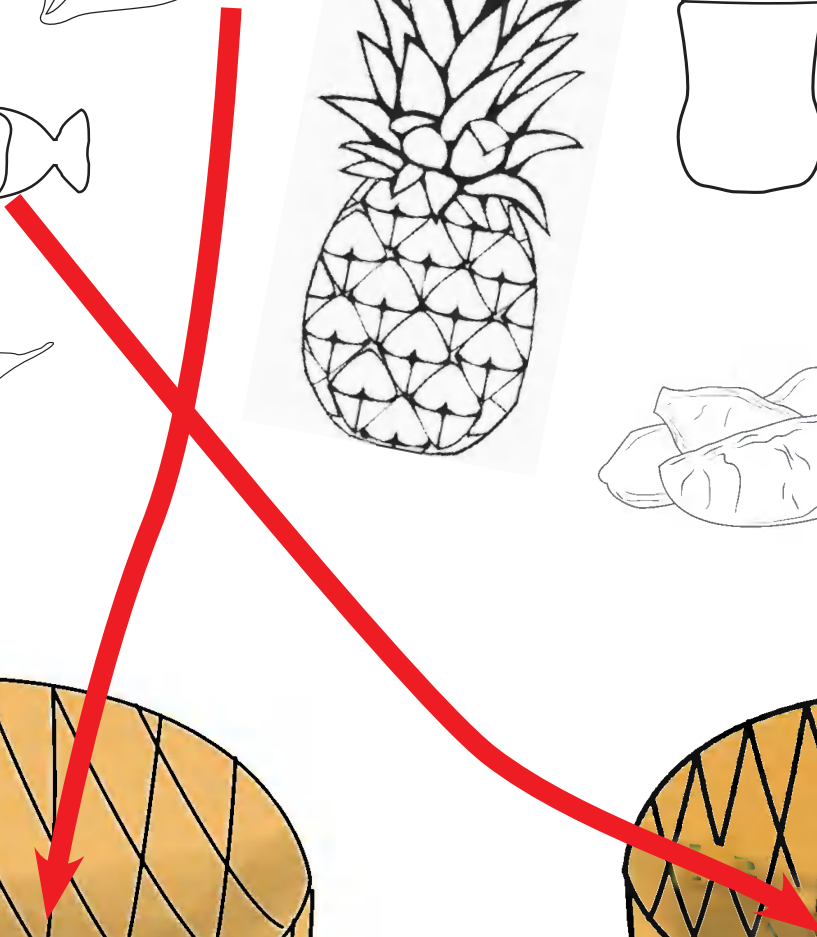
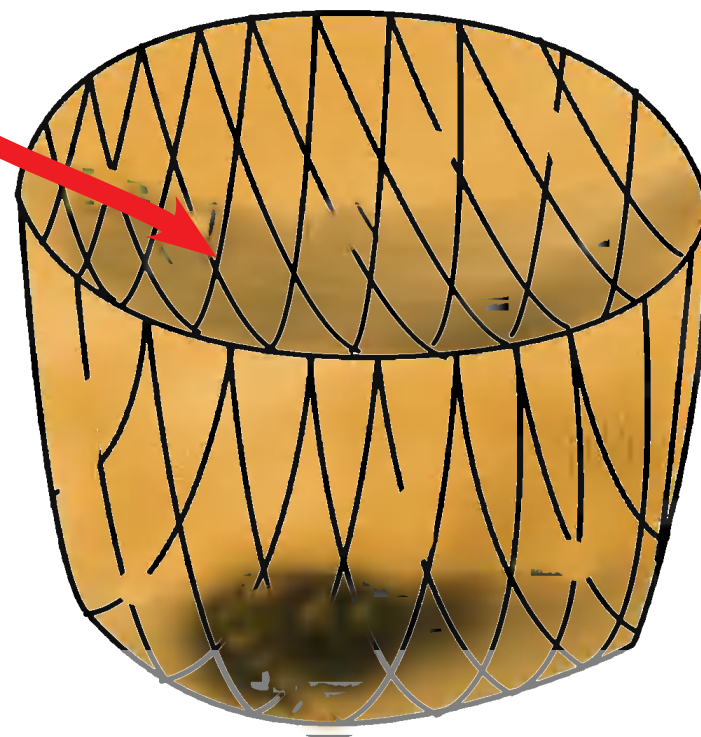
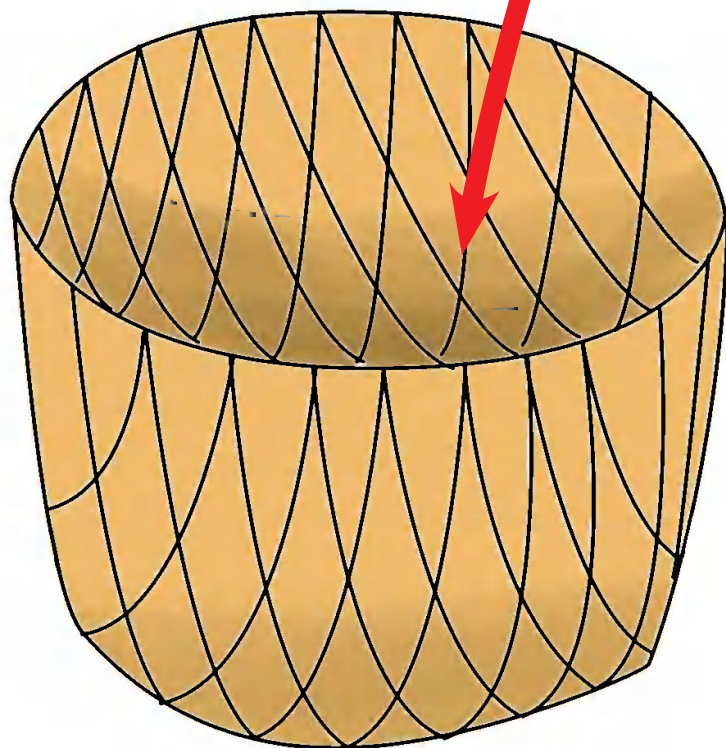
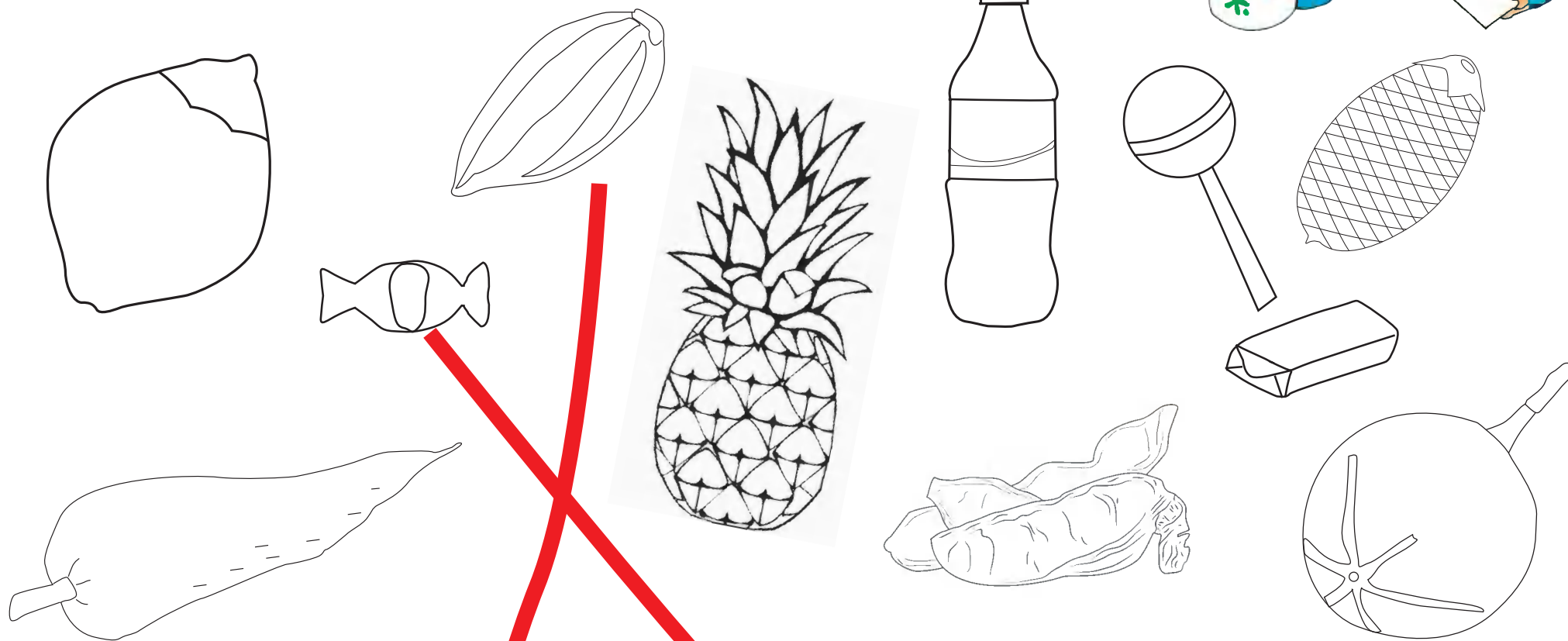

Winia naarka:

Penker wainkatniuitji ikiamnumia yuran yutai ainia nuu

Juunt irarsar inintrusmi wari yurankek ikiamnumia yutai ainia.

Juunt uchin ujawai.

Emkasar yuran yutsuk shiram nijartiniuitji tura nunia yuwatniuitji.

Juunt chichartamji pachitsuk yuranka yuwachtiniuitji nuniasha tee nukap yuran pachitsuk yuwachtiniuitji.

Yuranka ajakchatniuitji:

- ¿Yachia yurannasha yuwinia?
- ¿Nuikiartin uchin iniawai yachia yurannasha yuu armayi tusa?
- ¿Mashtik yuran yuta?
- ¿Warukua yumintrisha ayi?
- ¿Kuntincha yurannash yuk tarma?

Susata takakmati kirak yuram ainiaun nakumkarat tusam.

Yuran yutai ainiau juukam yakii penkaknum matsarta tura yuchati ainiauka nunkanam matsarta.



Washi aujmathsamu



Uwashinka yan chuikkia
aint ayayi tiniu armayyi
turayyat yan chuik nuwa
nawan suwa naarti
nuwatrukat tamatiat
nakitramu asa najanak
juunt uwechirinka
achintiak ajaprua tiniu
armayyi, turamu asa
washi uwechirinkia
chintiuk (4) ayi.

Sampi yuwaji tura kuntin uwejtin ainiausha yuwiniawai

¿Wari auj matsaji?

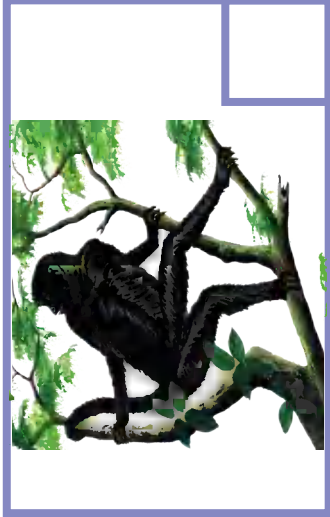

¿Washisha warnia yuyi?



¿Tuni pujuyi washish a?



Nakumkata washi turam yakarta.



Sampi yuwaji tura kuntin uwejtin ainiausha yuwiniawai

Nuikiartin uchin iniawai, wari kuntiniuk sampin yuminia tusa.

Ujawai uwejtin tura namamtim ainiausha sampinka yuwiniawai tusa.

Nuikiartin uchi nayanti awai.

Aarta washi aujmatmau pachisam:

- ¿Warukua ayi washisha?
- ¿Wari pachisa aujmatua?
- ¿Tuni pujuyi?

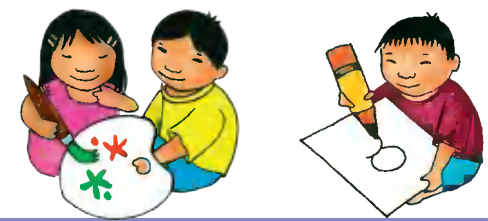

A large, empty rectangular area with a double blue border, intended for drawing or writing.

Winia naarka:

Yurak winia penker yutair

Tanté najanaram kemsaram aujmattsataram yuram atun nekamuram.

Unuikiartin achu takawai unuimatiniam uchin iniaktustas tura nunia iniasta warukua achu kunkurmarisha, usuamurisha aa tusa.

Uchi achun painkar minkar yuwiniawai:

- ¿Wari kuintinua achuncha yuyi?
- ¿Achu kunkukjai metekkai?
- ¿Kunkurmarisha metekkai?

Achu nunia kunkuki nere nakumkam yakarta tura stikernum pujuinia nuu anujrata Takakmati kirak susata.

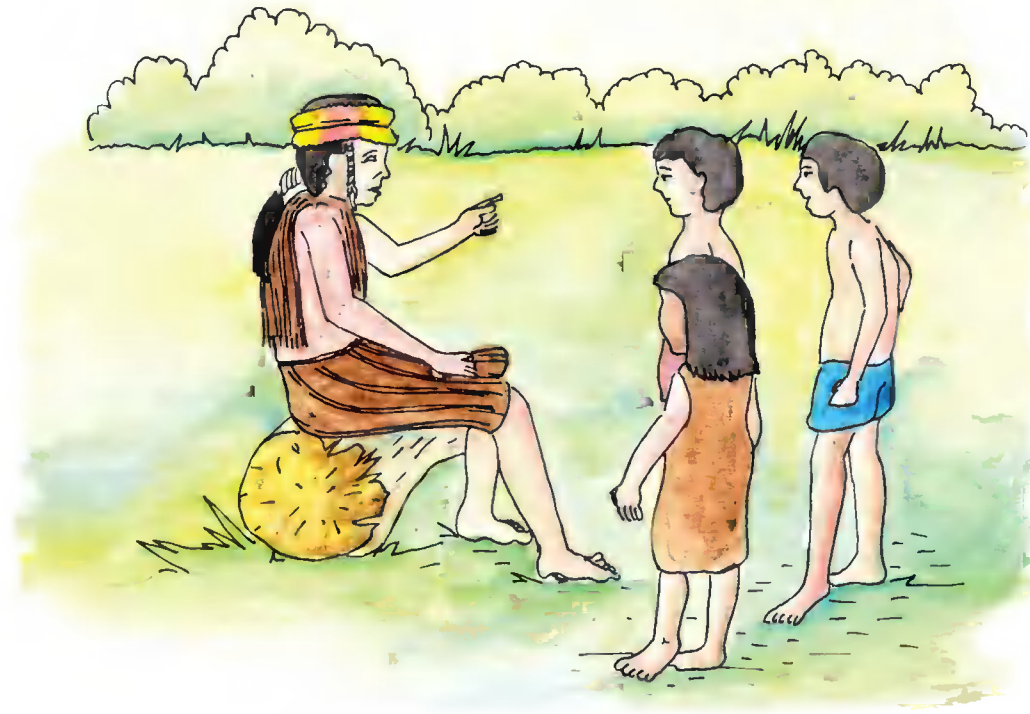

Ikiamnumia arak

Anmaya arak

Ikiamnumia yurak ainia nuna kunkurmari

Unuikiartin kiraknum ikiamnumia yuran nakumkaman nekainiawai.

Uchi ikiamnumia yuram kiraknum nakumkamu pujuiniaun jiisar iniainiawai.

Uchi ainia ikiamnumia yuran ainiaun ajanmaya yuran ainiauji patkar jiiniawai.

Uchi yurak ainiaun iniainiamti unuikiartin aawai.

¿Tunian ikiamnumia yurannasha arainia?

Yuran ikiannumiaa ainiau, sampi, pau, shuwia.

Yuran ajanmaya ainiau. Papaij, yaas, wampá kukuchi akai.

Arak ikiamnum tsapau ainia.

Sampi



Pau

Achu

Kunkuk

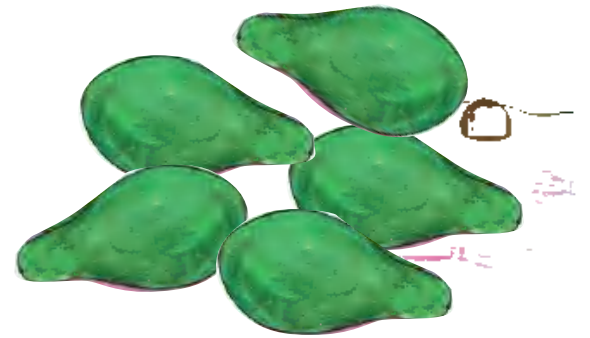
Aanumia arak amu



Winia naarka:

Yuran suramu

Unuikiartin aujmatui yuranka akik ainiawai tusa tura nuniasha yuwar jaertin penke penkeraitiai tawai.

Nuiniarta achu arakmatin.

Uchi kichik kichik seata achu jinkiaji tsapain itiataram ajanam arakmi tusam.

Nuikiartin juuntan ipiawai uchi ainiaun achu itiu aratniuki nuna nekapruat tusa.

Nuimiatirin waketkiar aujmatiniawai juunt achu itiu aratniuitji timia nuna.

Iruntrar aujmatiniawai arakmatin pachisar.

Takakmati kirak uchi susata achu jinkiaji tsapainiaru nakumkamu stiker num pujuinia nuna anujrarat tusam.



Winia naarka:

Warutan yurankek takakaij

Junikiar apach jiweaji warutmak ikiamnum yuran iruna nuna ujatmakat tusar.

Uchi antiniawai apach ikiamnumia yuranken pachis aujmatmati.

Unumiatirin waketkiar aujmatiniawai apach yuranken pachis aujmattsama nuna pachisar

Unuikiartin uchi ainiaun iniawai wainniukuram juu yuran tusa:

- ¿Wainiukuram juu yuran?
- ¿Tuni juu yuransha iruna?

Junikiar yuran ikiamnum irunum jiwenawai.

Yuran wainkamurin warukuka nuna pachisar aujmatiniawai.

Nakuminiawai tura yakainiawai yuram wainkamurin.

Takakmati kirak uchi susarta yuran ainiau stikernum nakumkamun anujrarat tusam.



Winia naarka:

Junis ati tamau.

- Jintinkratatin ame takasmaurumnia paan iniakmasta ame wakerukmaurum, nuniasha itiuur ii pujutri kajinmattsuk unuimiartinki tamau unimiartinki tamau unuimiarmame nuu paan awajsata.

Ii pujutri kajinmatsuk unuimiartiniuitji tusar aarmaji nuu paan iniakmasan nakumkam yakarta tura nunia charurta.



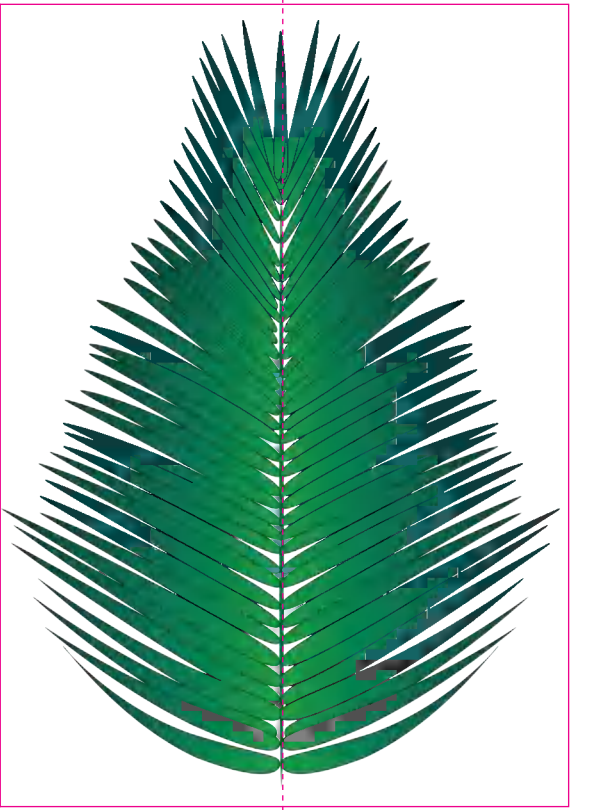
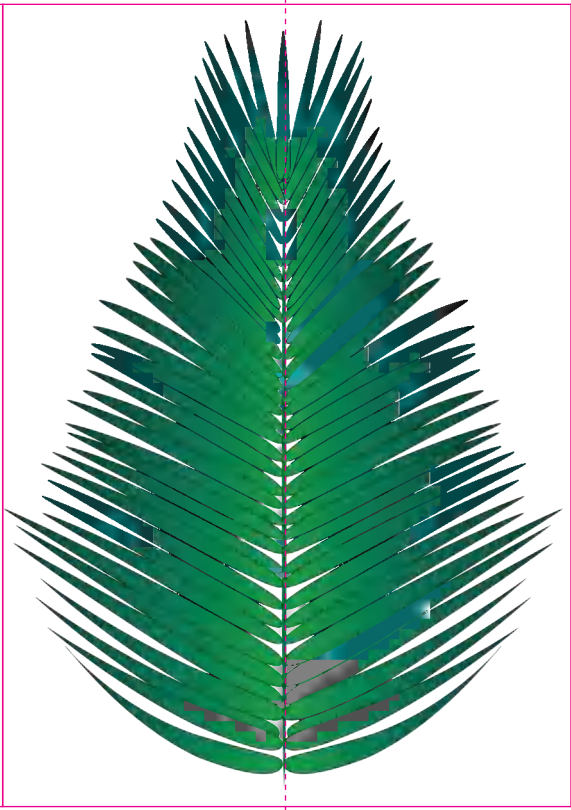
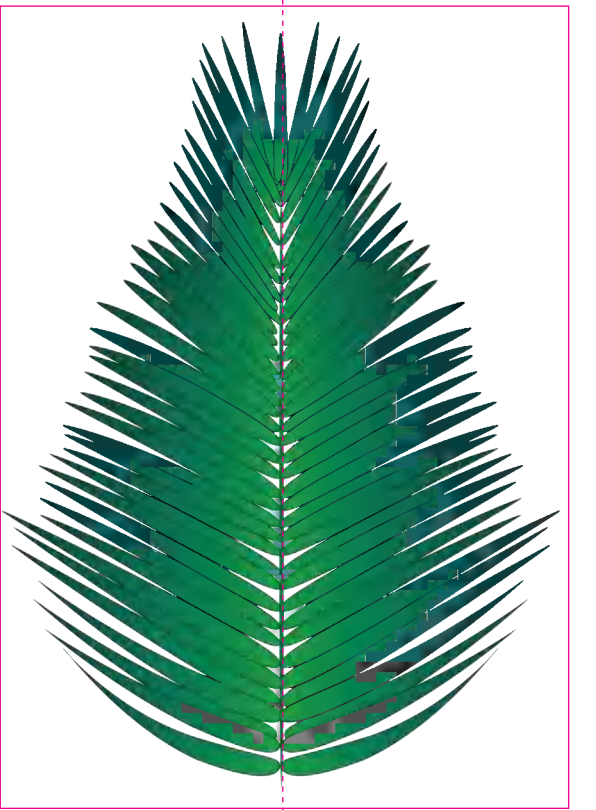
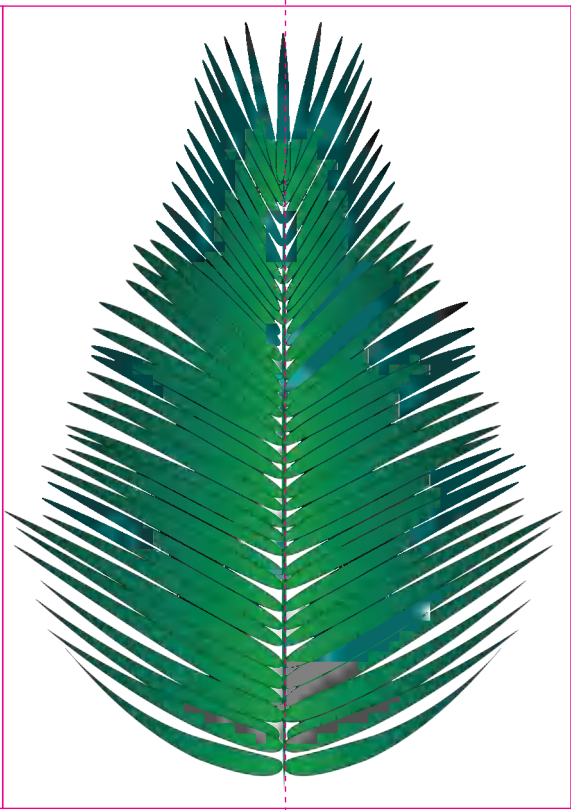
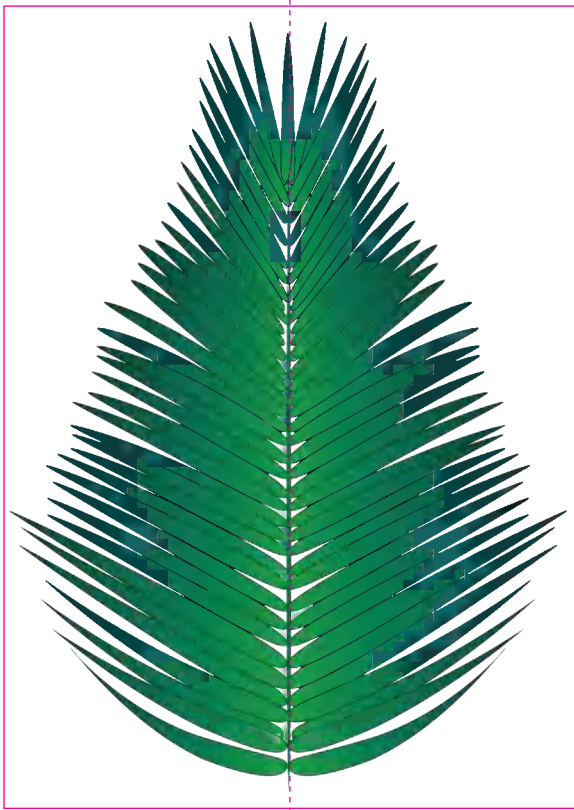

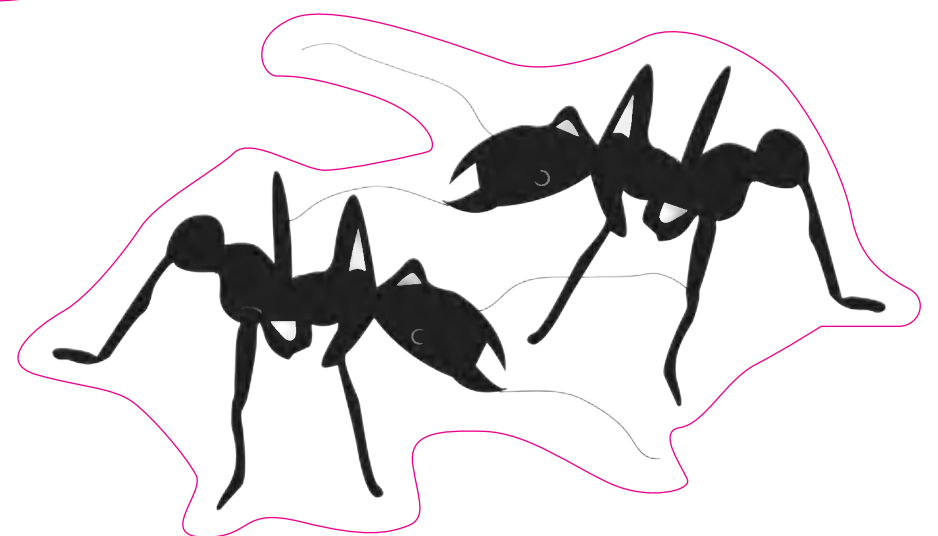
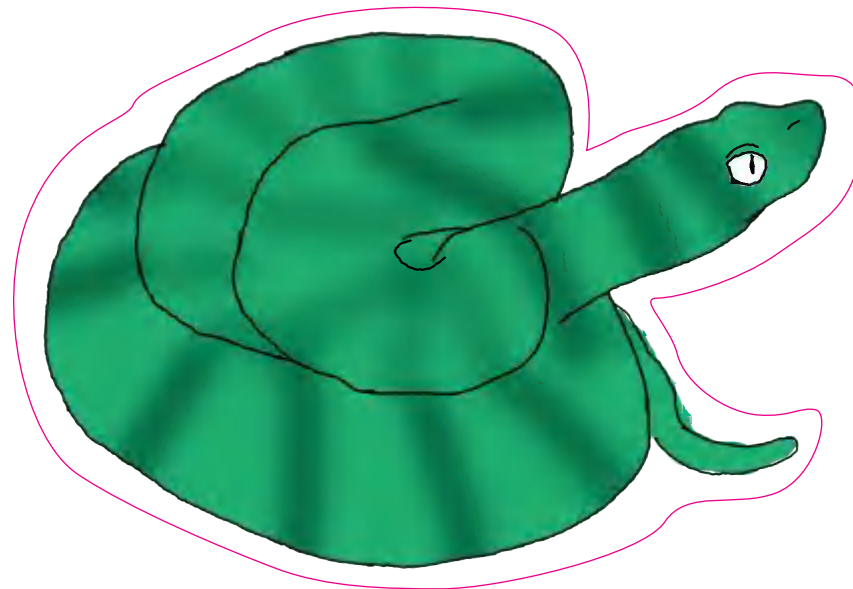
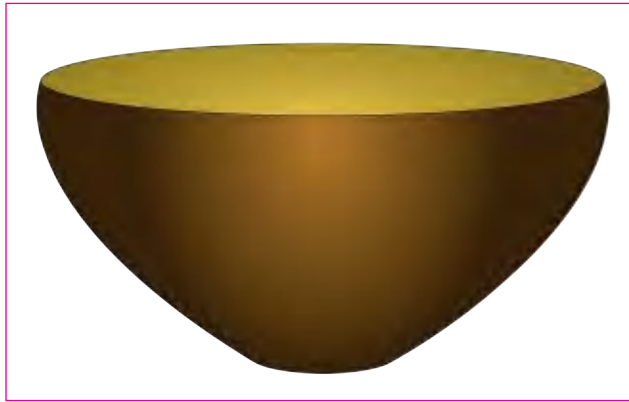

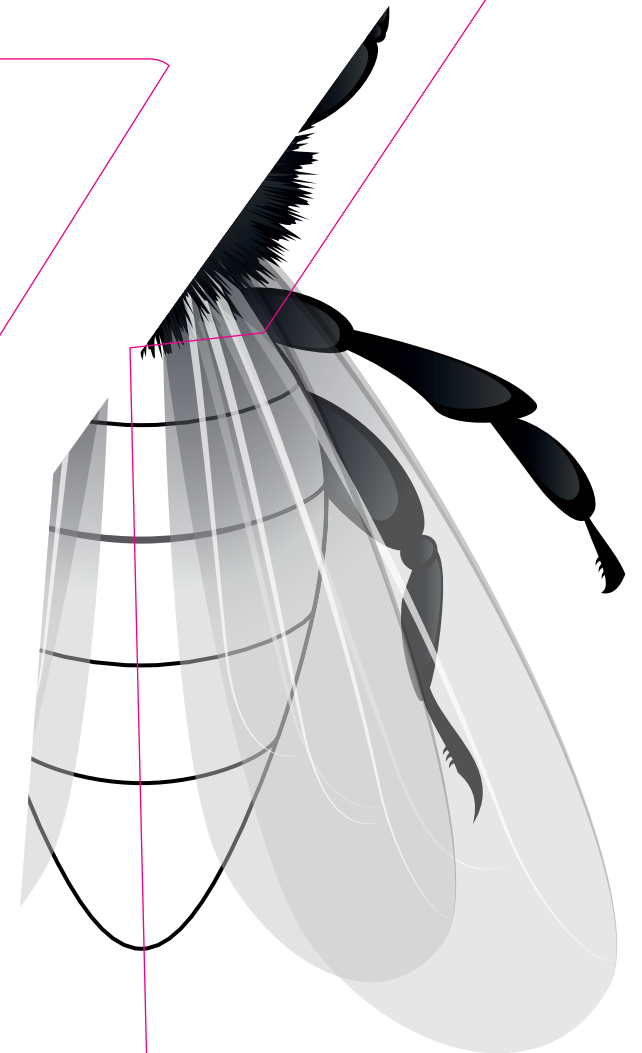
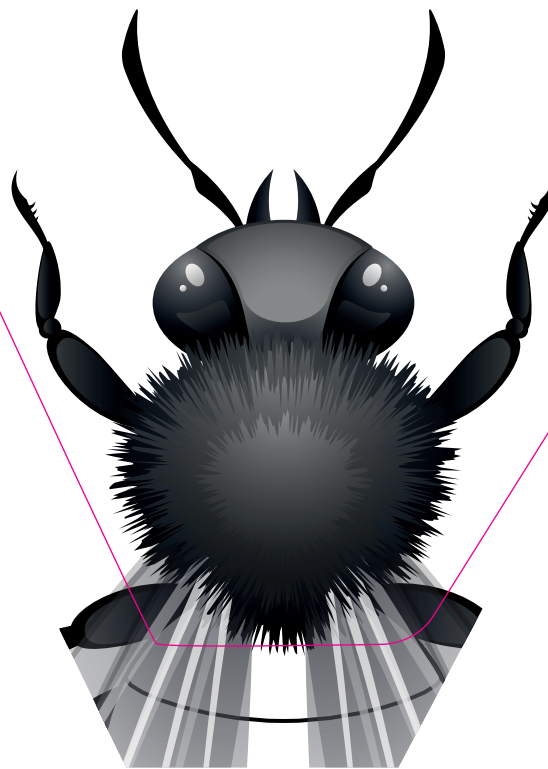
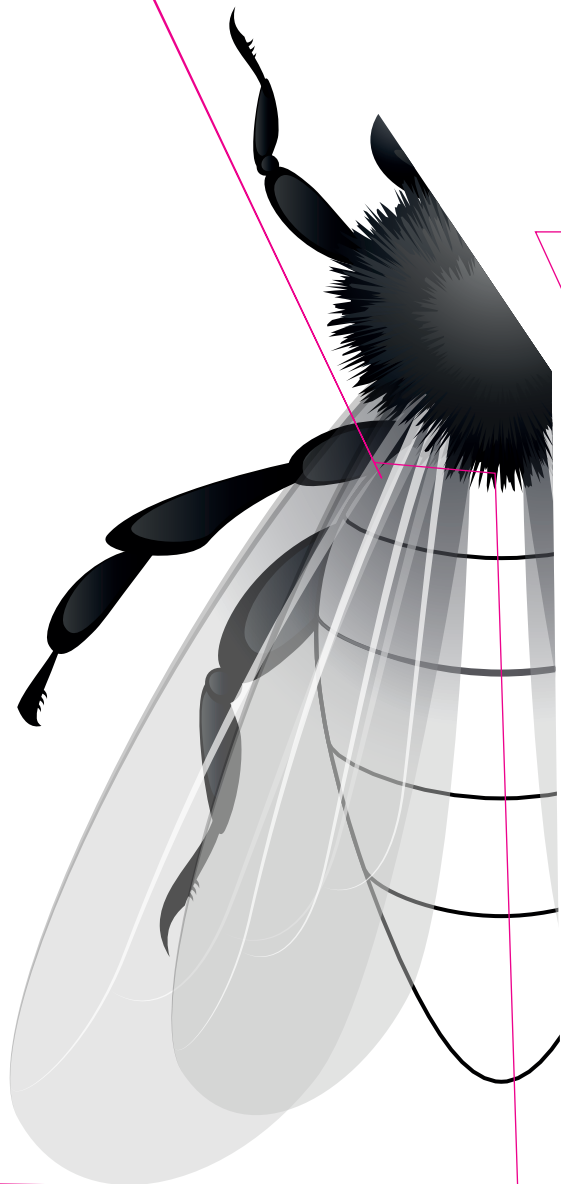



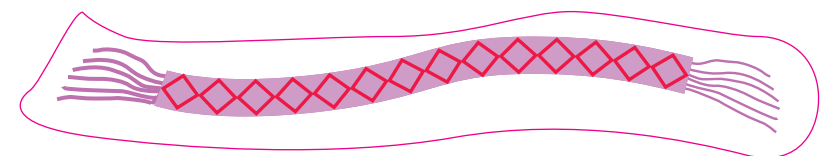
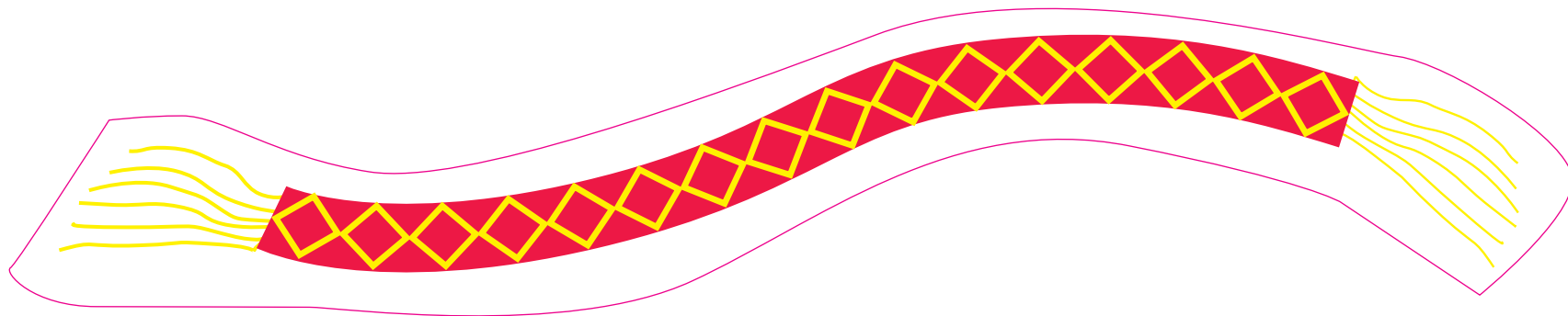
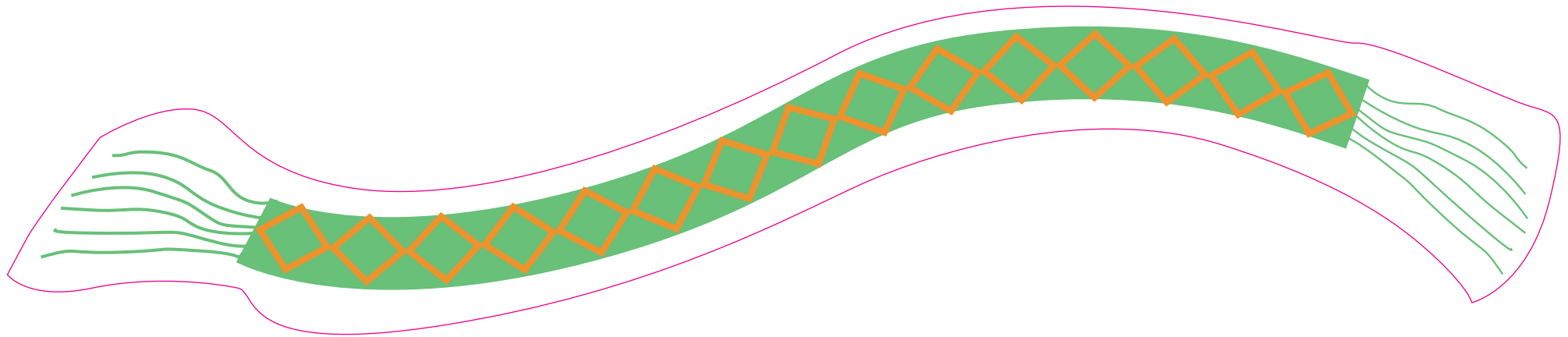
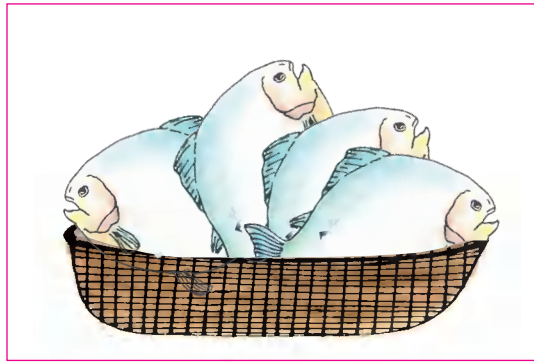

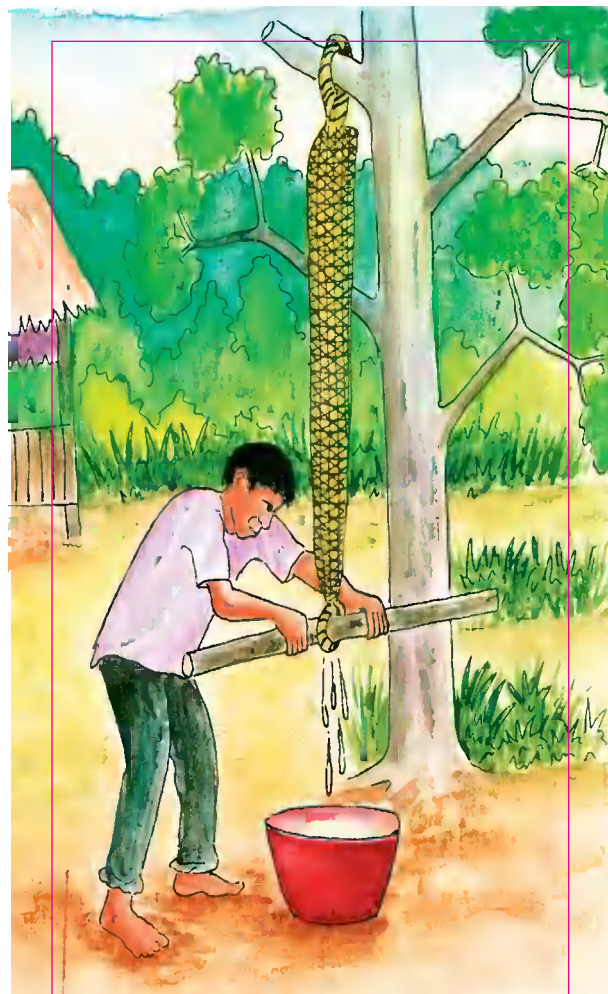
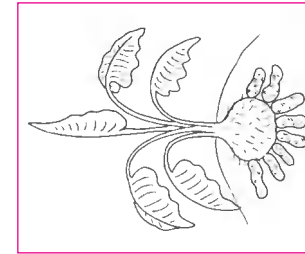
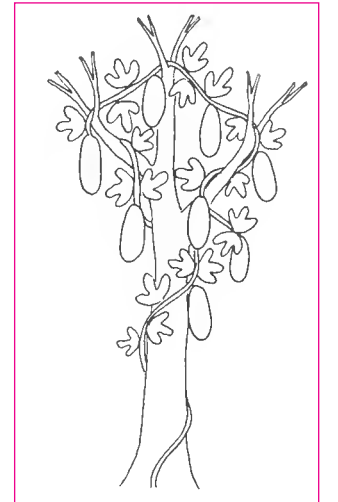
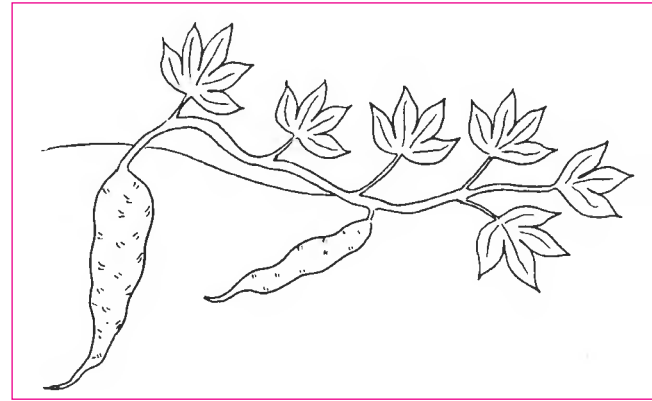
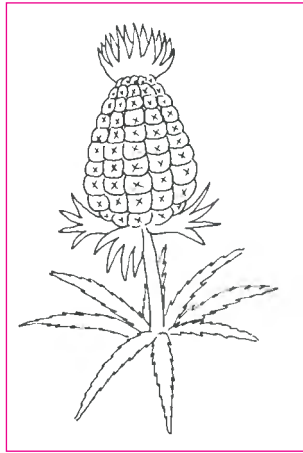
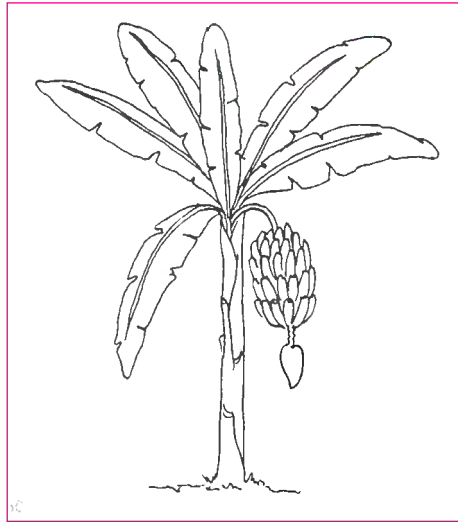
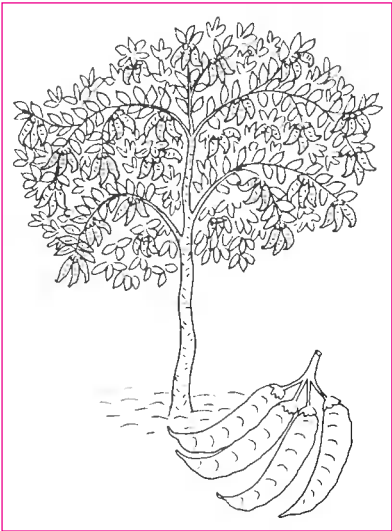

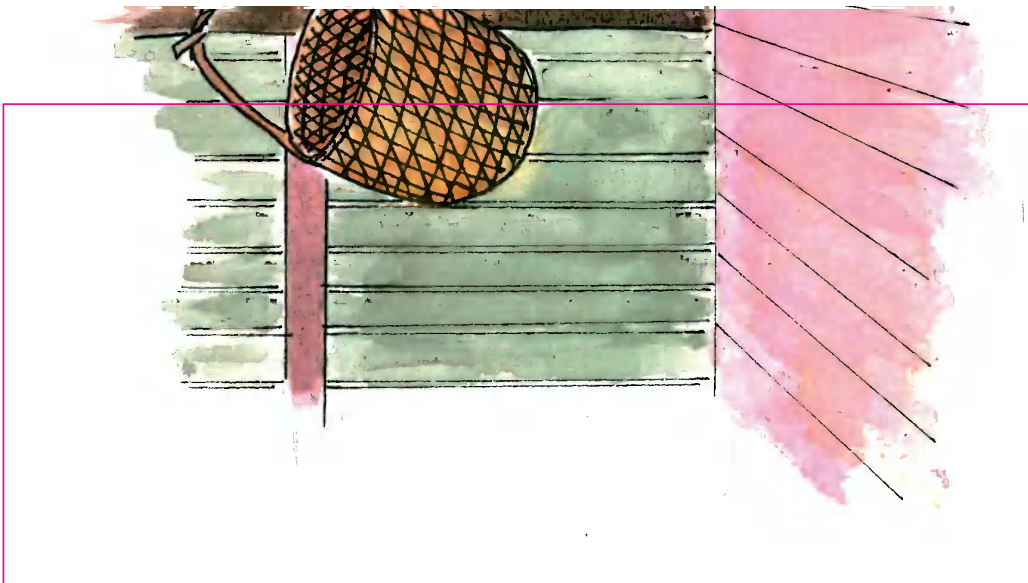
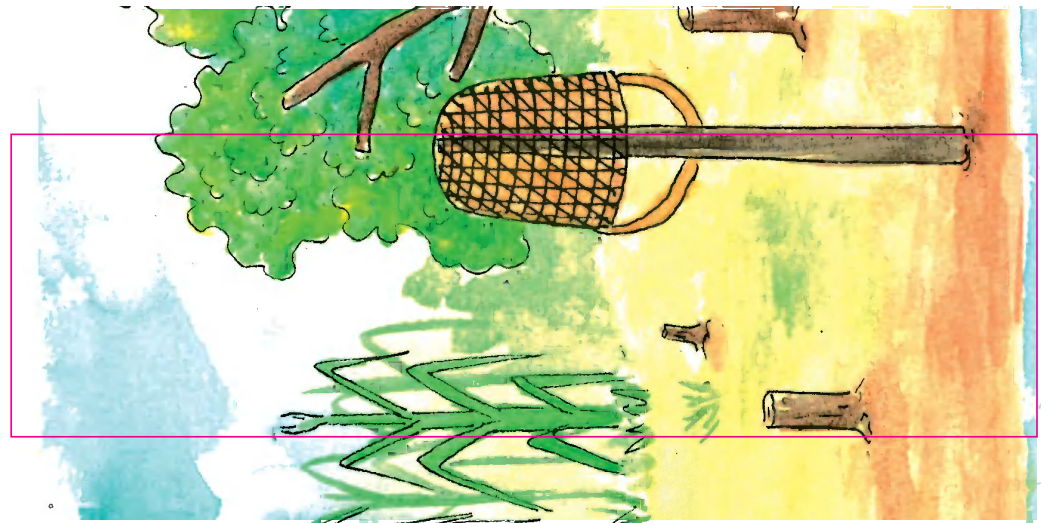
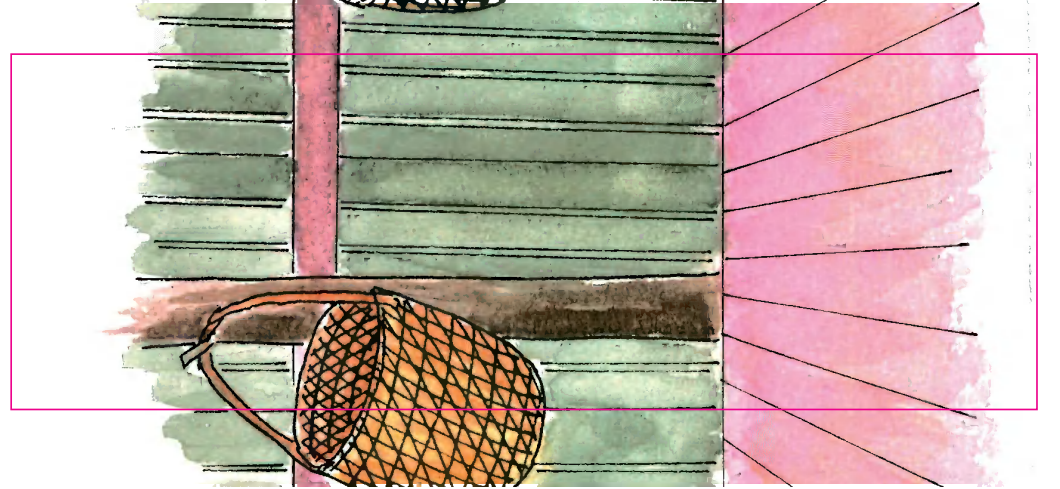

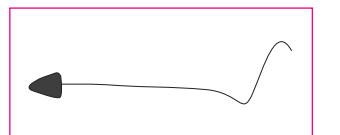
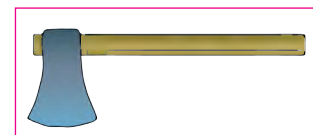
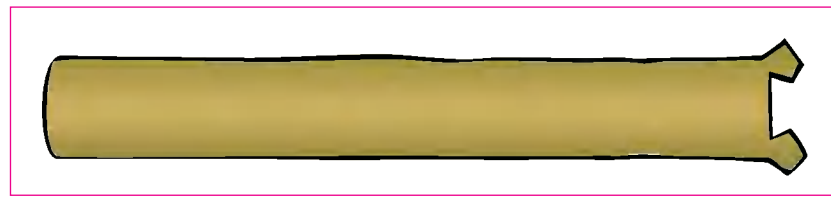
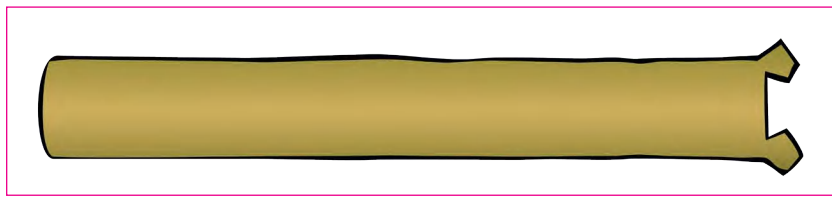
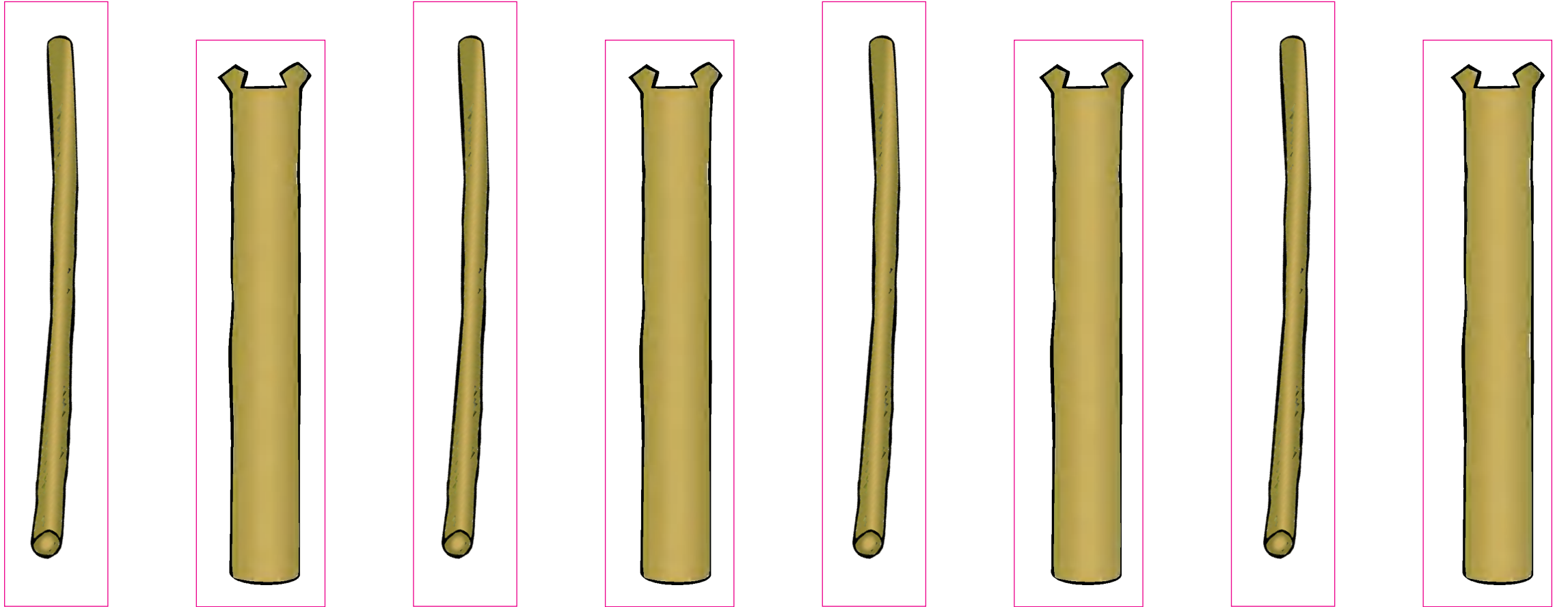

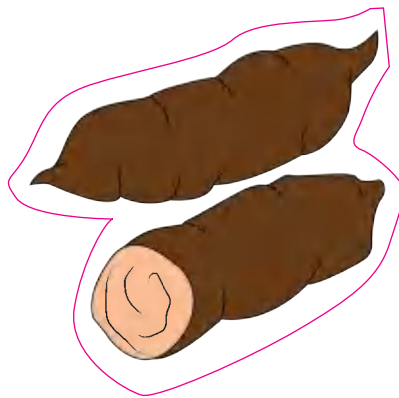
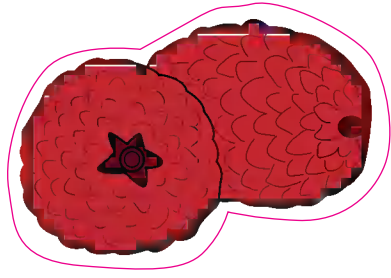
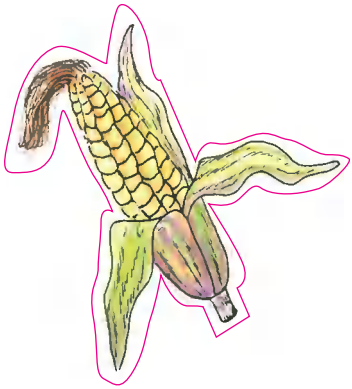
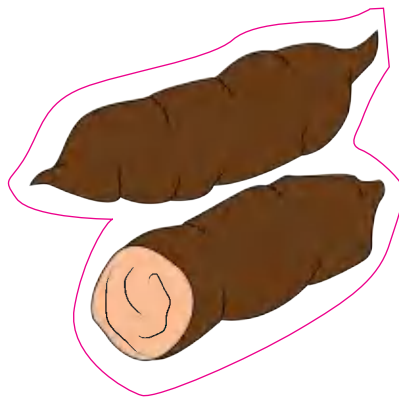
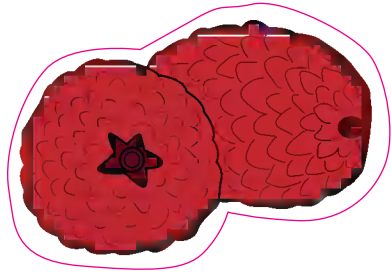
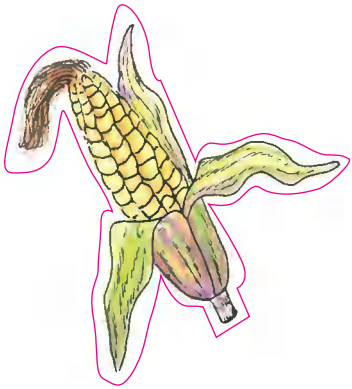
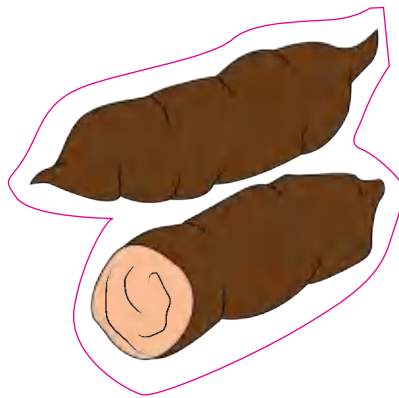
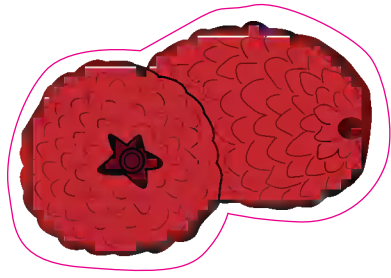
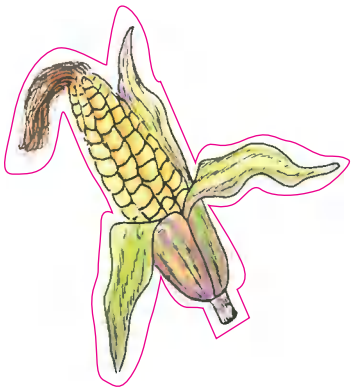
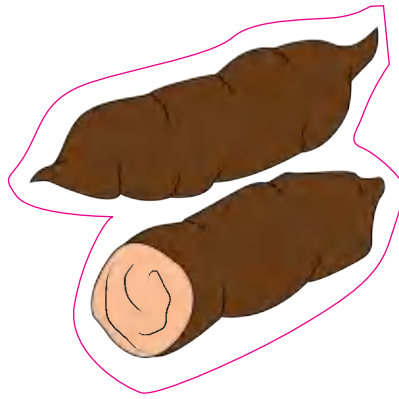
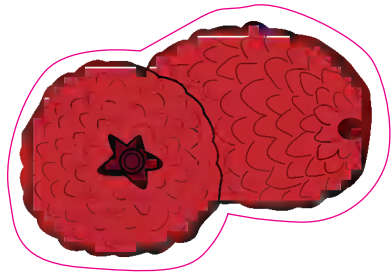
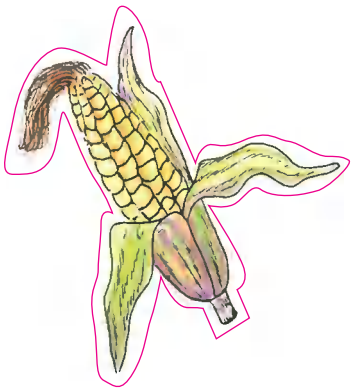

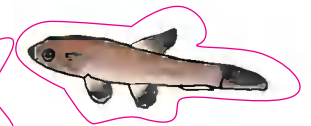
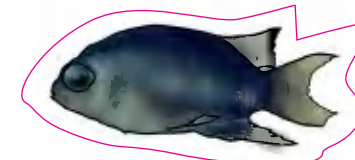
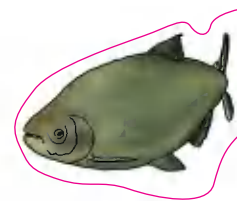
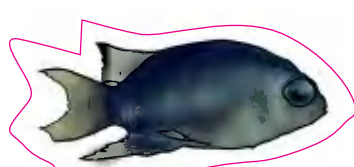
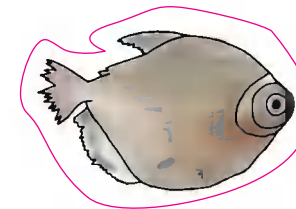
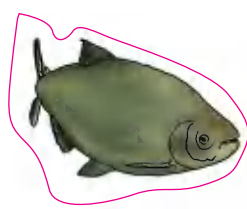
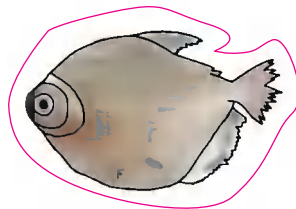
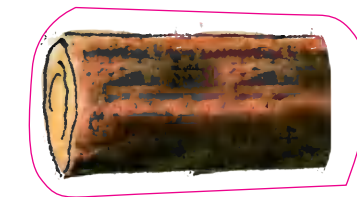
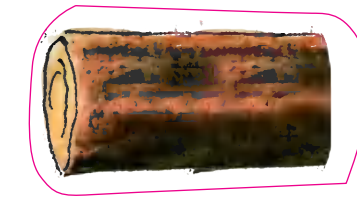
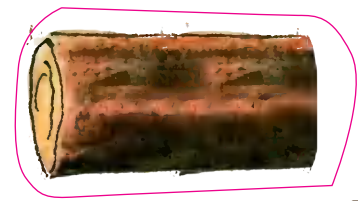
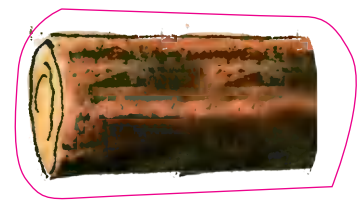
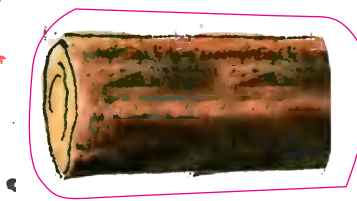
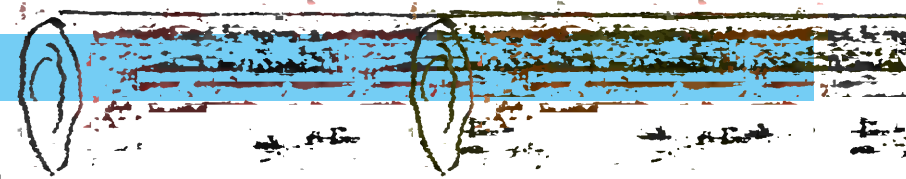
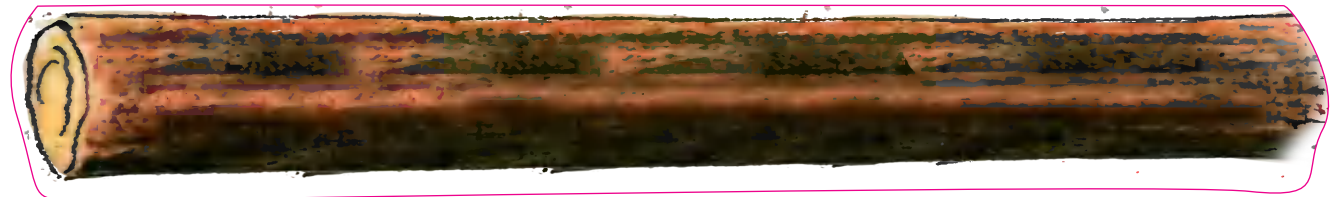
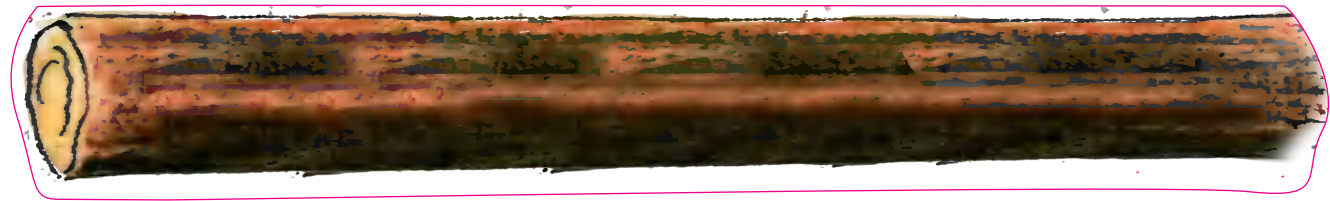
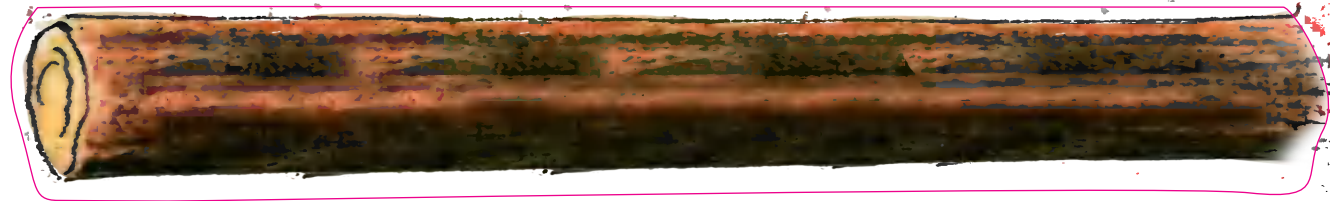

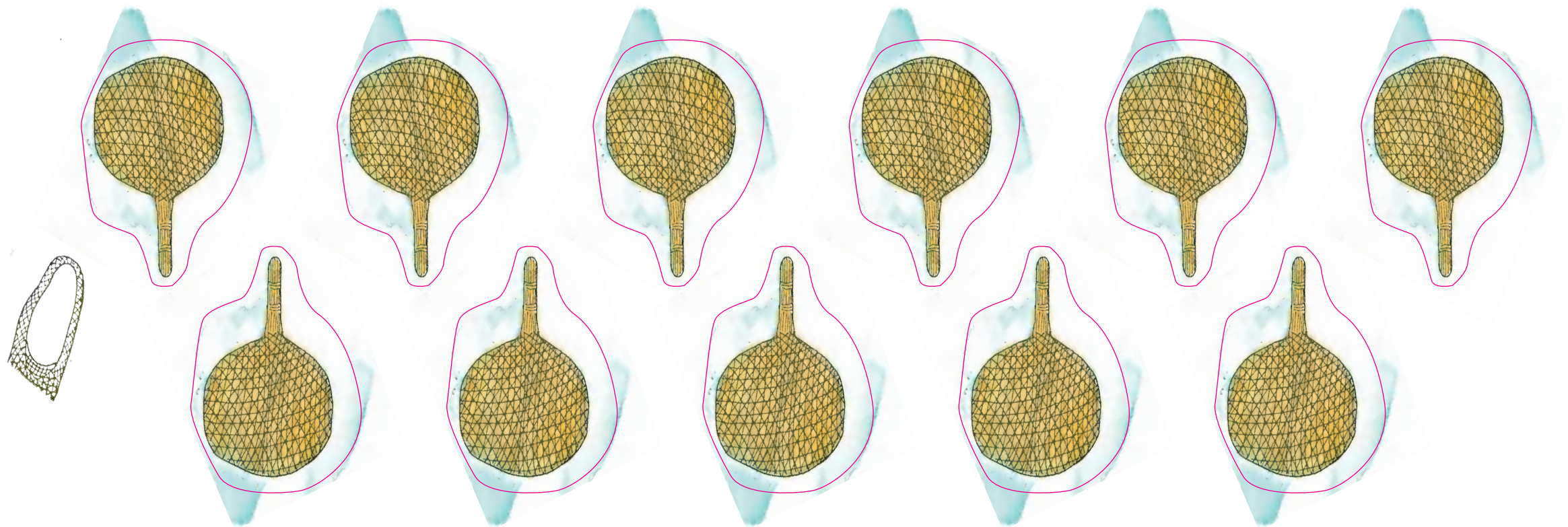
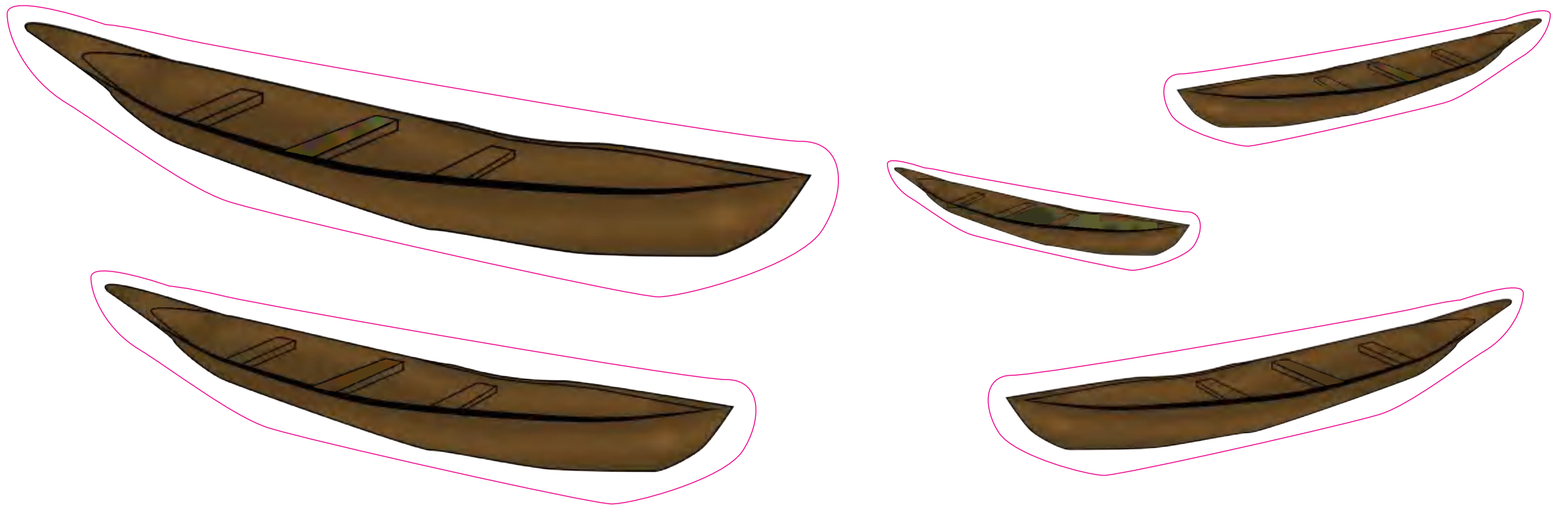

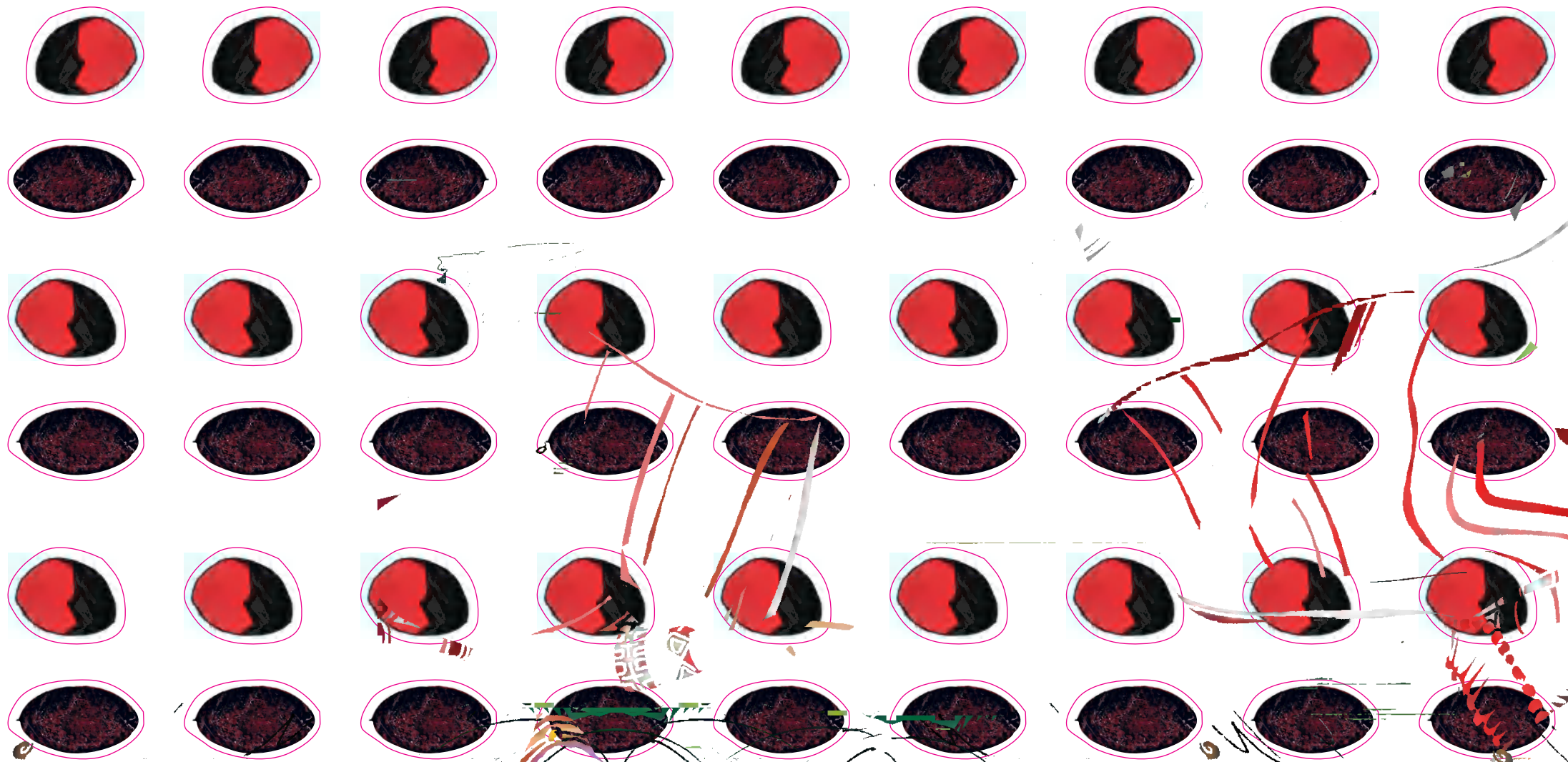

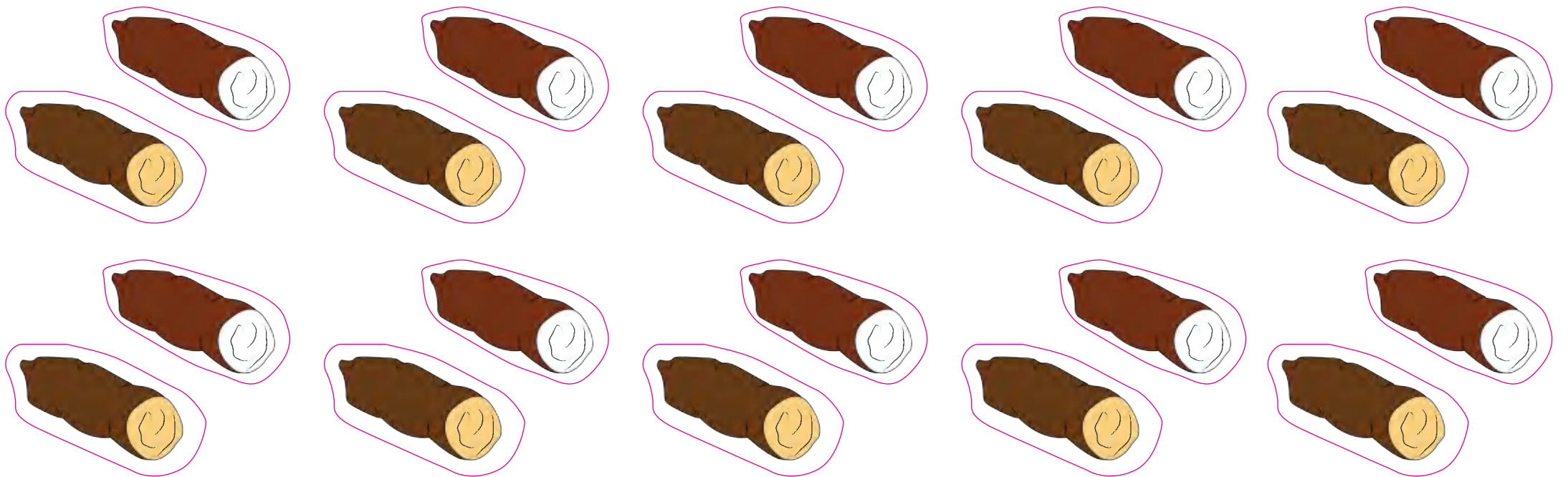

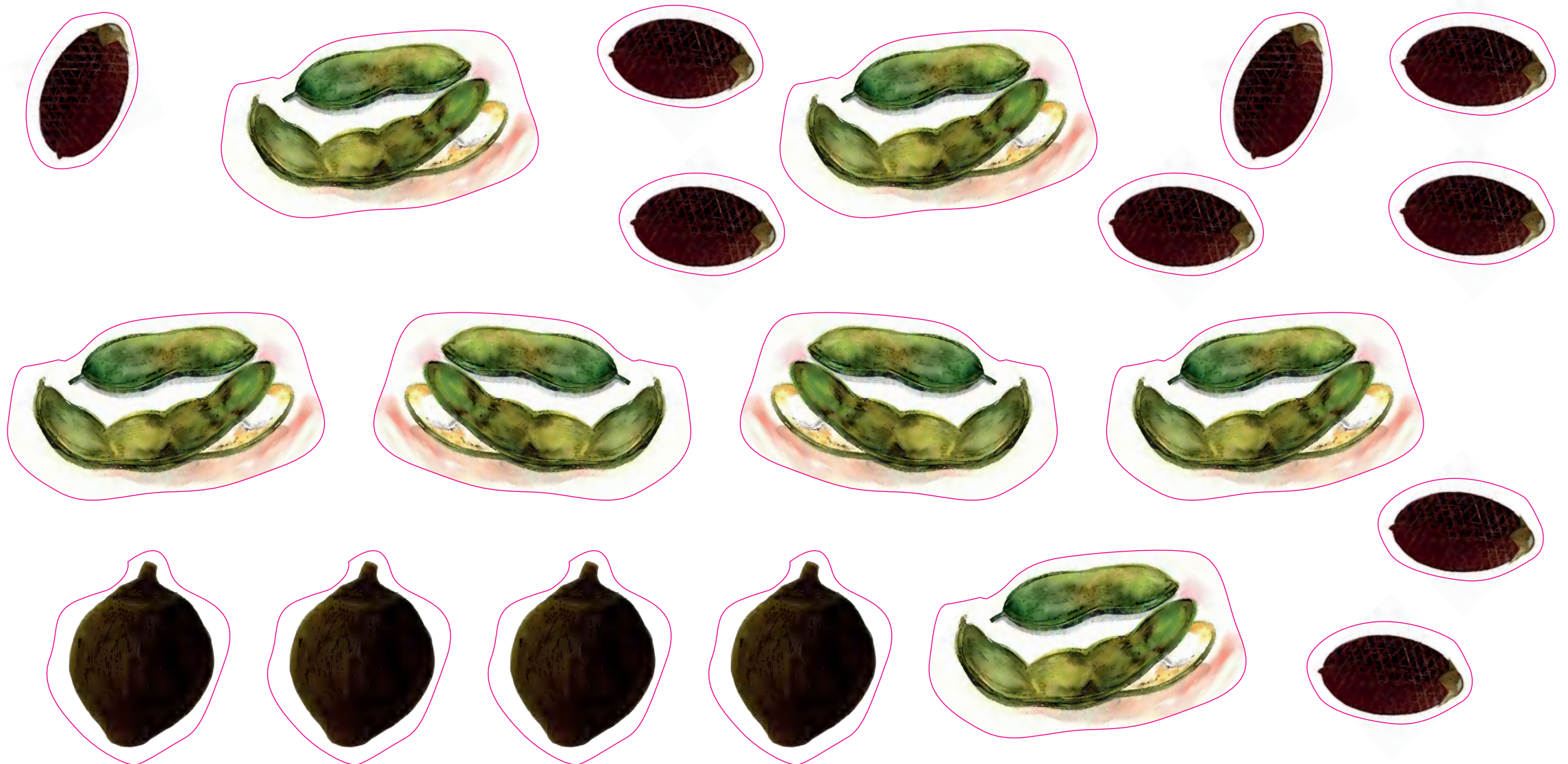
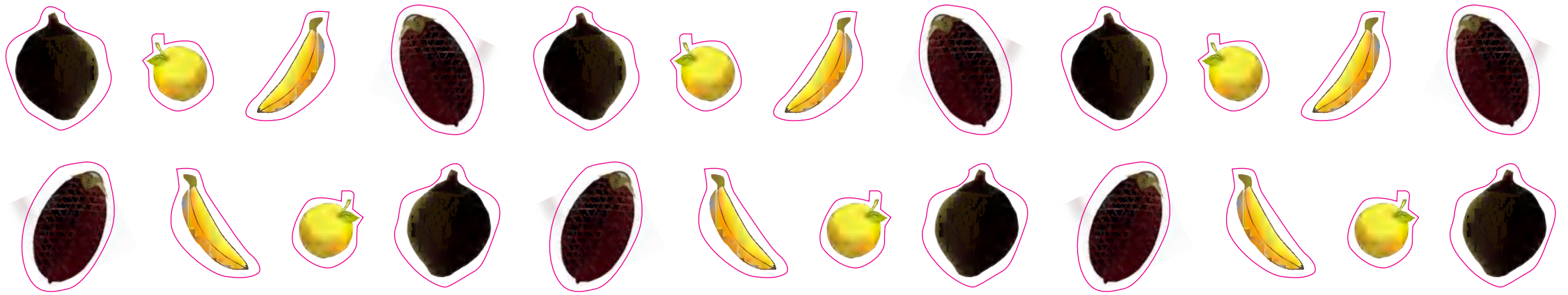



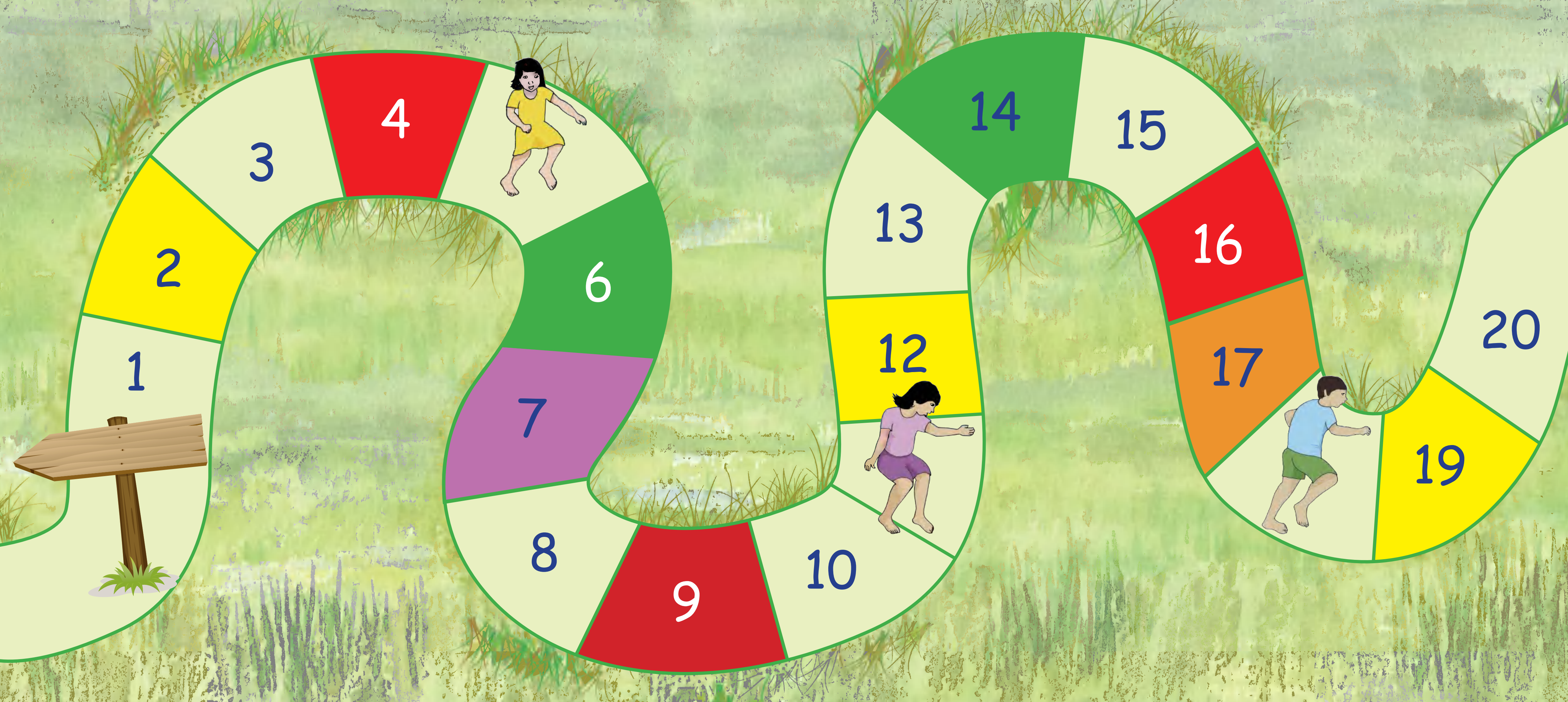

1

2

3

4

6

7

8

9

10

12

13

14

15

16

17

19

20



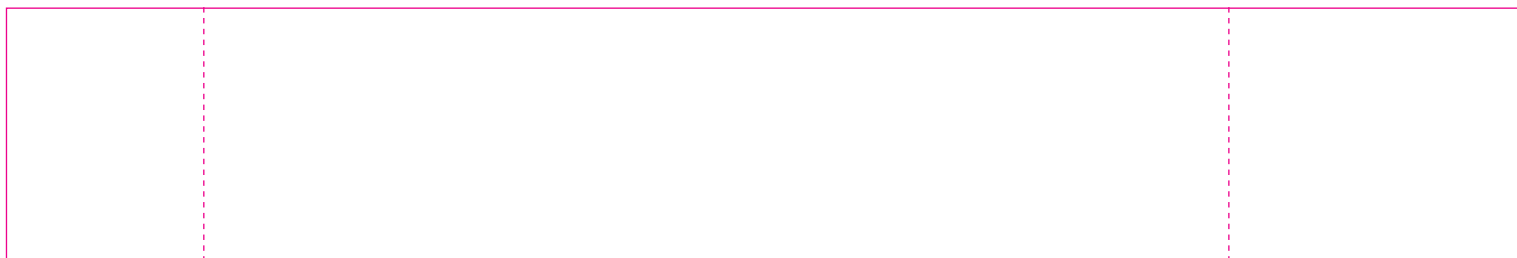
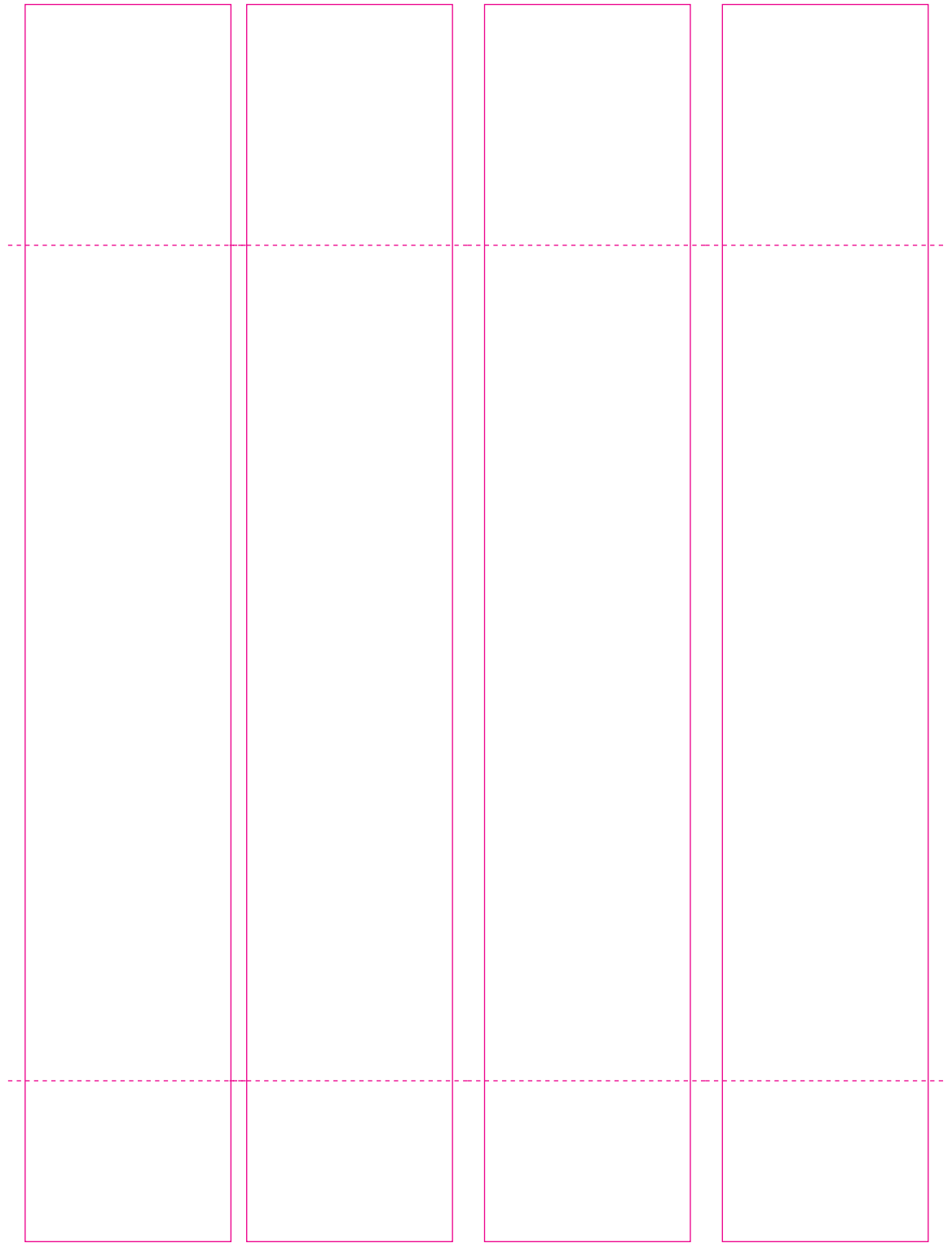
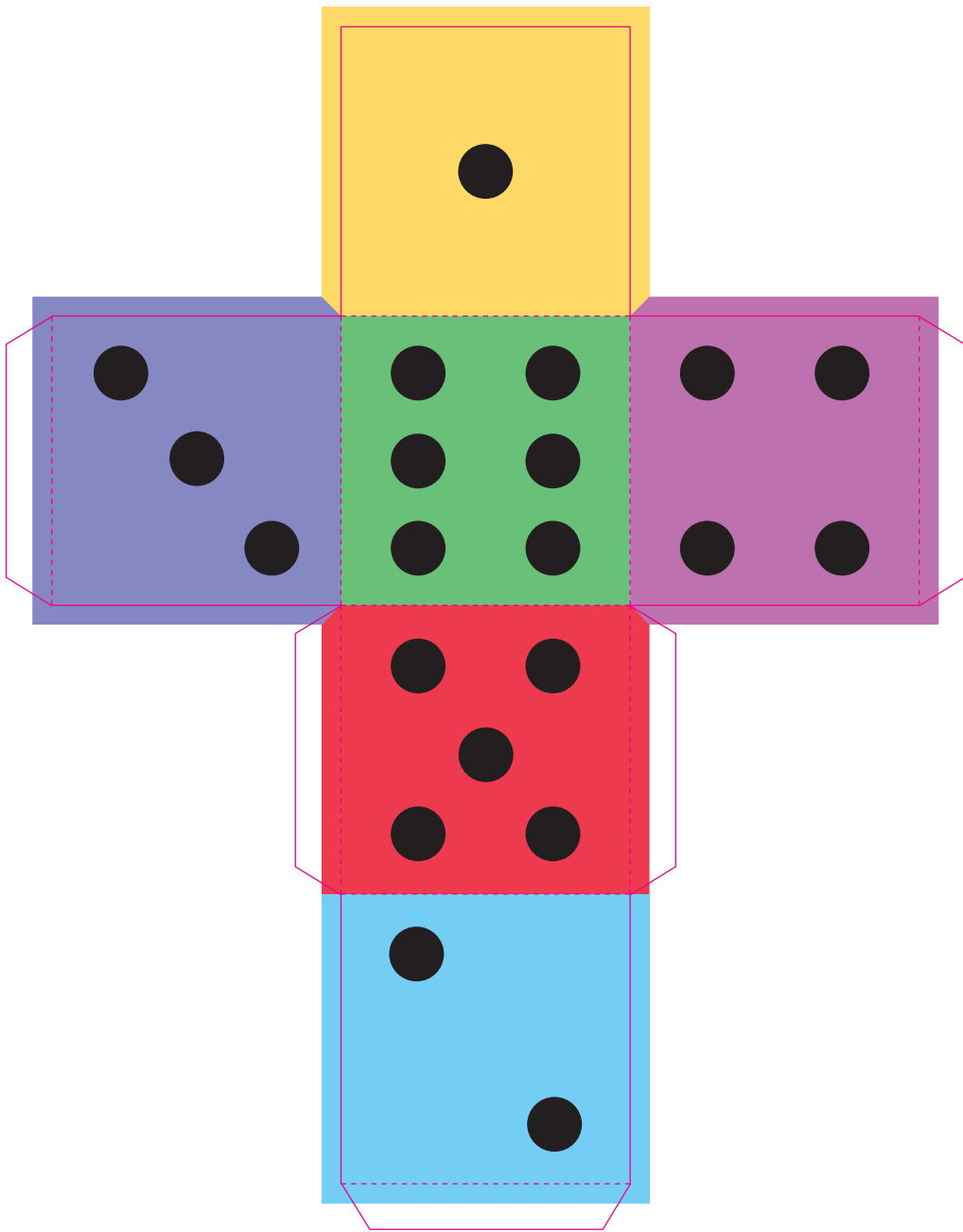

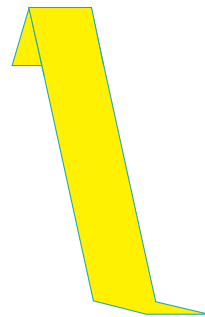
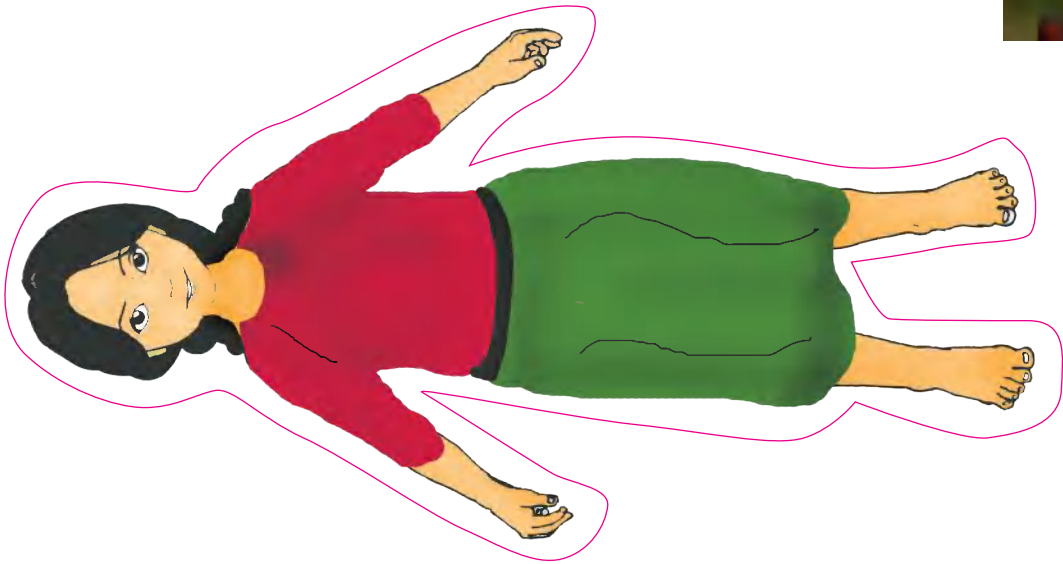
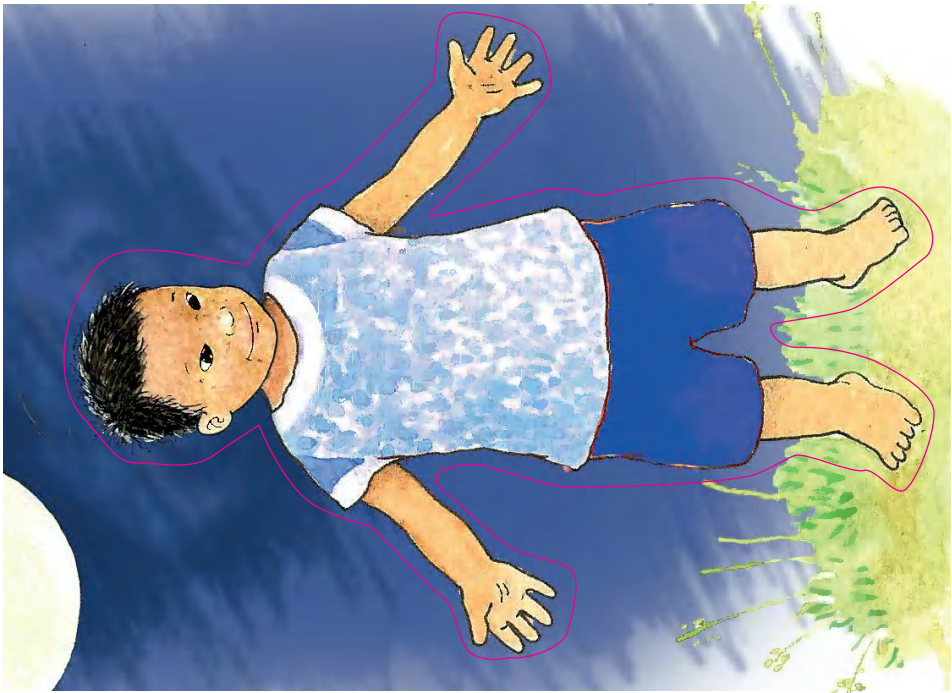
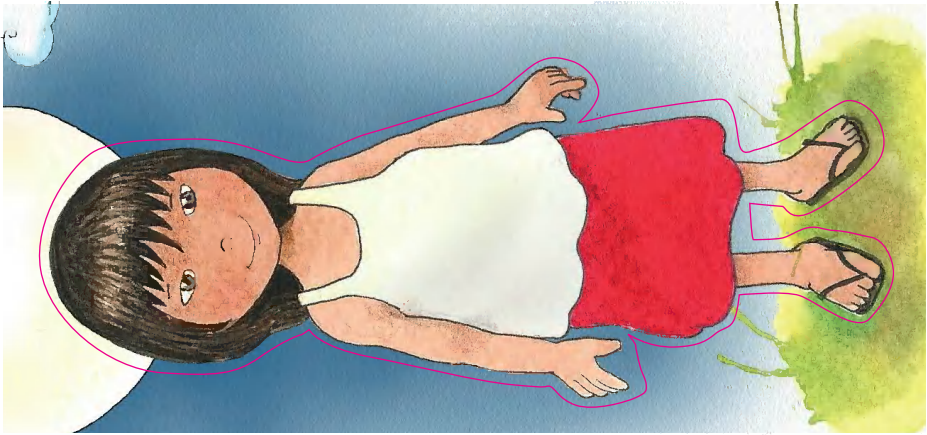

El Acuerdo Nacional

El 22 de julio de 2002, los representantes de las organizaciones políticas, religiosas, del Gobierno y de la sociedad civil firmaron el compromiso de trabajar, todos, para conseguir el bienestar y desarrollo del país. Este compromiso es el Acuerdo Nacional.

El Acuerdo persigue cuatro objetivos fundamentales. Para alcanzarlos, todos los peruanos de buena voluntad tenemos, desde el lugar que ocupemos o el rol que desempeñemos, el deber y la responsabilidad de decidir, ejecutar, vigilar o defender los compromisos asumidos. Estos son tan importantes que serán respetados como políticas permanentes para el futuro.

Por esta razón, como niños, niñas, adolescentes o adultos, ya sea como estudiantes o trabajadores, debemos promover y fortalecer acciones que garanticen el cumplimiento de esos cuatro objetivos que son los siguientes:

1. Democracia y Estado de Derecho

La justicia, la paz y el desarrollo que necesitamos los peruanos sólo se pueden dar si conseguimos una verdadera democracia. El compromiso del Acuerdo Nacional es garantizar una sociedad en la que los derechos son respetados y los ciudadanos viven seguros y expresan con libertad sus opiniones a partir del diálogo abierto y enriquecedor; decidiendo lo mejor para el país.

2. Equidad y Justicia Social

Para poder construir nuestra democracia, es necesario que cada una de las personas que con-

formamos esta sociedad, nos sintamos parte de ella. Con este fin, el Acuerdo promoverá el acceso a las oportunidades económicas, sociales, culturales y políticas. Todos los peruanos tenemos derecho a un empleo digno, a una educación de calidad, a una salud integral, a un lugar para vivir. Así, alcanzaremos el desarrollo pleno.

3. Competitividad del País

Para afianzar la economía, el Acuerdo se compromete a fomentar el espíritu de competitividad en las empresas, es decir, mejorar la calidad de los productos y servicios, asegurar el acceso a la formalización de las pequeñas empresas y sumar esfuerzos para fomentar la colocación de nuestros productos en los mercados internacionales.

4. Estado Eficiente, Transparente y Descentralizado

Es de vital importancia que el Estado cumpla con sus obligaciones de manera eficiente y transparente para ponerse al servicio de todos los peruanos. El Acuerdo se compromete a modernizar la administración pública, desarrollar instrumentos que eliminen la corrupción o el uso indebido del poder. Asimismo, descentralizar el poder y la economía para asegurar que el Estado sirva a todos los peruanos sin excepción. Mediante el Acuerdo Nacional nos comprometemos a desarrollar maneras de controlar el cumplimiento de estas políticas de Estado, a brindar apoyo y difundir constantemente sus acciones a la sociedad en general.

Declaración Universal de los Derechos Humanos

El 10 de diciembre de 1948, la Asamblea General de las Naciones Unidas aprobó y proclamó la Declaración Universal de Derechos Humanos, cuyos artículos figuran a continuación:

Artículo 1.- Todos los seres humanos nacen libres e iguales en dignidad y derechos y (...) deben comportarse fraternalmente los unos con los otros.

Artículo 2.- Toda persona tiene todos los derechos y libertades proclamados en esta Declaración, sin distinción alguna de raza, color, sexo, idioma, religión, opinión política o de cualquier otra índole, origen nacional o social, posición económica, nacimiento o cualquier otra condición. Además, no se hará distinción alguna fundada en la condición política, jurídica o internacional del país o territorio de cuya jurisdicción dependa una persona (...).

Artículo 3.- Todo individuo tiene derecho a la vida, a la libertad y a la seguridad de su persona.

Artículo 4.- Nadie estará sometido a esclavitud ni a servidumbre; la esclavitud y la trata de esclavos están prohibidas en todas sus formas.

Artículo 5.- Nadie será sometido a torturas ni a penas o tratos crueles, inhumanos o degradantes.

Artículo 6.- Todo ser humano tiene derecho, en todas partes, al reconocimiento de su personalidad jurídica.

Artículo 7.- Todos son iguales ante la ley y tienen, sin distinción, derecho a igual protección de la ley. Todos tienen derecho a igual protección contra toda discriminación que infrinja esta Declaración (...).

Artículo 8.- Toda persona tiene derecho a un recurso efectivo, ante los tribunales nacionales competentes, que la ampare contra actos que violen sus derechos fundamentales (...).

Artículo 9.- Nadie podrá ser arbitrariamente detenido, preso ni desterrado.

Artículo 10.- Toda persona tiene derecho, en condiciones de plena igualdad, a ser oída públicamente y con justicia por un tribunal independiente e imparcial, para la determinación de sus derechos y obligaciones o para el examen de cualquier acusación contra ella en materia penal.

Artículo 11.-

1. Toda persona acusada de delito tiene derecho a que se presuma su inocencia mientras no se pruebe su culpabilidad (...).

2. Nadie será condenado por actos u omisiones que en el momento de cometerse no fueron delictivos según el Derecho nacional o internacional. Tampoco se impondrá pena más grave que la aplicable en el momento de la comisión del delito.

Artículo 12.- Nadie será objeto de injerencias arbitrarias en su vida privada, su familia, su domicilio o su correspondencia, ni de ataques a su honra o a su reputación. Toda persona tiene derecho a la protección de la ley contra tales injerencias o ataques.

Artículo 13.-

1. Toda persona tiene derecho a circular libremente y a elegir su residencia en el territorio de un Estado.

2. Toda persona tiene derecho a salir de cualquier país, incluso del propio, y a regresar a su país.

Artículo 14.-

1. En caso de persecución, toda persona tiene derecho a buscar asilo, y a disfrutar de él, en cualquier país.

2. Este derecho no podrá ser invocado contra una acción judicial realmente originada por delitos comunes o por actos opuestos a los propósitos y principios de las Naciones Unidas.

Artículo 15.-

1. Toda persona tiene derecho a una nacionalidad.

2. A nadie se privará arbitrariamente de su nacionalidad ni del derecho a cambiar de nacionalidad.

Artículo 16.-

1. Los hombres y las mujeres, a partir de la edad núbil, tienen derecho, sin restricción alguna por motivos de raza, nacionalidad o religión, a casarse y fundar una familia (...).

2. Sólo mediante libre y pleno consentimiento de los futuros esposos podrá contraerse el matrimonio.

3. La familia es el elemento natural y fundamental de la sociedad y tiene derecho a la protección de la sociedad y del Estado.

Artículo 17.-

1. Toda persona tiene derecho a la propiedad, individual y colectivamente.

2. Nadie será privado arbitrariamente de su propiedad.

Artículo 18.- Toda persona tiene derecho a la libertad de pensamiento, de conciencia y de religión (...).

Artículo 19.- Todo individuo tiene derecho a la libertad de opinión y de expresión (...).

Artículo 20.-

1. Toda persona tiene derecho a la libertad de reunión y de asociación pacíficas.

2. Nadie podrá ser obligado a pertenecer a una asociación.

Artículo 21.-

1. Toda persona tiene derecho a participar en el gobierno de su país, directamente o por medio de representantes libremente escogidos.

2. Toda persona tiene el derecho de acceso, en condiciones de igualdad, a las funciones públicas de su país.

3. La voluntad del pueblo es la base de la autoridad del poder público; esta voluntad se expresará mediante elecciones auténticas que habrán de celebrarse periódicamente, por sufragio universal e igual y por voto secreto u otro procedimiento equivalente que garantice la libertad del voto.

Artículo 22.- Toda persona (...) tiene derecho a la seguridad social, y a obtener (...) habida cuenta de la organización y los recursos de cada Estado, la satisfacción de los derechos económicos, sociales y culturales, indispensables a su dignidad y al libre desarrollo de su personalidad.

Artículo 23.-

1. Toda persona tiene derecho al trabajo, a la libre elección de su trabajo, a condiciones equitativas y satisfactorias de trabajo y a la protección contra el desempleo.

2. Toda persona tiene derecho, sin discriminación alguna, a igual salario por trabajo igual.

3. Toda persona que trabaja tiene derecho a una remuneración equitativa y satisfactoria, que le asegure, así como a su familia, una existencia conforme a la dignidad humana y que será completada, en caso necesario, por cualesquiera otros medios de protección social.

4. Toda persona tiene derecho a fundar sindicatos y a sindicarse para la defensa de sus intereses.

Artículo 24.-

Toda persona tiene derecho al descanso, al disfrute del tiempo libre, a una limitación razonable de la duración del trabajo y a vacaciones periódicas pagadas.

Artículo 25.-

1. Toda persona tiene derecho a un nivel de vida adecuado que le asegure, así como a su familia, la salud y el bienestar, y en especial la alimentación, el vestido, la vivienda, la asistencia médica y los servicios sociales necesarios; tiene asimismo derecho a los seguros en caso de desempleo, enfermedad, invalidez, viudez, vejez u otros casos de pérdida de sus medios de subsistencia por circunstancias independientes de su voluntad.

2. La maternidad y la infancia tienen derecho a cuidados y asistencia especiales. Todos los niños, nacidos de matrimonio o fuera de matrimonio, tienen derecho a igual protección social.

Artículo 26.-

1. Toda persona tiene derecho a la educación. La educación debe ser gratuita, al menos en lo concerniente a la instrucción elemental y fundamental. La instrucción elemental será obligatoria. La instrucción técnica y profesional habrá de ser generalizada; el acceso a los estudios superiores será igual para todos, en función de los méritos respectivos.

2. La educación tendrá por objeto el pleno desarrollo de la personalidad humana y el fortalecimiento del respeto a los derechos humanos y a las libertades fundamentales; favorecerá la comprensión, la tolerancia y la amistad entre todas las naciones y todos los grupos étnicos o religiosos; y promoverá el desarrollo de las actividades de las Naciones Unidas para el mantenimiento de la paz.

3. Los padres tendrán derecho preferente a escoger el tipo de educación que habrá de darse a sus hijos.

Artículo 27.-

1. Toda persona tiene derecho a tomar parte libremente en la vida cultural de la comunidad, a gozar de las artes y a participar en el progreso científico y en los beneficios que de él resulten.

2. Toda persona tiene derecho a la protección de los intereses morales y materiales que le correspondan por razón de las producciones científicas, literarias o artísticas de que sea autora.

Artículo 28.- Toda persona tiene derecho a que se establezca un orden social e internacional en el que los derechos y libertades proclamados en esta Declaración se hagan plenamente efectivos.

Artículo 29.-

1. Toda persona tiene deberes respecto a la comunidad (...).

2. En el ejercicio de sus derechos y en el disfrute de sus libertades, toda persona estará solamente sujeta a las limitaciones establecidas por la ley con el único fin de asegurar el reconocimiento y el respeto de los derechos y libertades de los demás, y de satisfacer las justas exigencias de la moral, del orden público y del bienestar general en una sociedad democrática.

3. Estos derechos y libertades no podrán, en ningún caso, ser ejercidos en oposición a los propósitos y principios de las Naciones Unidas.

Artículo 30.- Nada en esta Declaración podrá interpretarse en el sentido de que confiere derecho alguno al Estado, a un grupo o a una persona, para emprender y desarrollar actividades (...) tendientes a la supresión de cualquiera de los derechos y libertades proclamados en esta Declaración.

SÍMBOLOS DE LA PATRIA



BANDERA NACIONAL



HIMNO NACIONAL CORO

Somos libres, seámoslo siempre,
y ante niegue sus luces el Sol,
que faltemos al voto solemne
que la Patria al Eterno elevó.

HIMNO NACIONAL



ESCUDO NACIONAL

DISTRIBUCIÓN GRATUITA
PROHIBIDA SU VENTA